



**KABA<sup>®</sup>**

# **E-PLEX<sup>®</sup>**

5X10 EXIT TRIM MODELS  
INSTALLATION INSTRUCTIONS

# TABLE OF CONTENTS

---

Assembly Drawing .....	3
Tools Required .....	4
A. Door Preparation - Exit Device .....	5
B. Door Preparation - E5000 Exit Trim .....	6
C. Install Exit Device .....	6
D. Door Thickness .....	7
E. Assemble Outside Unit to Universal Mounting Plate .....	7
F. Lock Handing .....	7
G. Changing Key-In-Lever (KIL) Cylinder .....	8
H. Installing/Removing Outside Lever (Key-In-Lever Models) .....	9
I. Installing/Removing Outside Lever (Interchangeable/Removable Core Models) .....	9
J. Installing E5x00 Exit Trim .....	11
K. Installing The Battery Pack and Cover Changing Batteries .....	12
L. Testing the Operation of the Lock .....	13
M. Programming and Software Settings .....	14

---

## **Warning**

**The Master Code of this lock has been factory preset: 1,2,3,4,5,6,7,8. To activate lock functions, the master combination must be changed at time of installation.**

## **Warnings and Cautions**

**Important:** Carefully inspect windows, doorframe, door, lights, etc. to ensure that the recommended procedures will not cause damage. Kaba Access Control's warranty does not cover damages caused by installation.

**Caution:** Wear safety glasses when preparing door.

# E-PLEX 5x10 Exit Trim Model

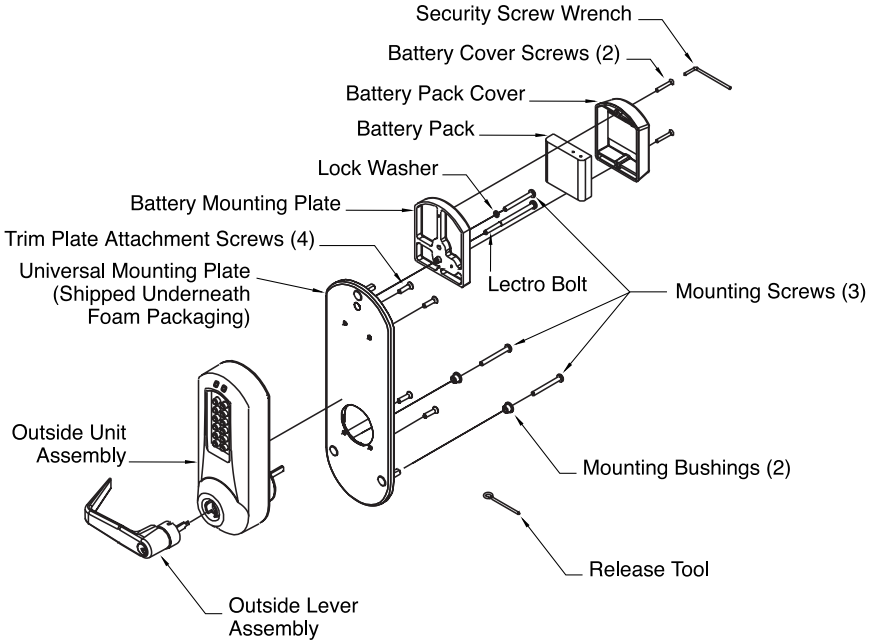

The E-Plex Exit Trim Lock is adaptable to a wide variety of the more popular exit devices on the market today. No tools are required to reverse handing, and the spring loaded tailpiece drive automatically adjusts to door thicknesses from 1 3/4" to 2 1/8". A door thickness of up to 2 1/4" inches can be accommodated through the addition of a spacer ring. The E-Plex Exit Trim accommodates through bolt mounting as used in most fire rated installations as well as surface mounted applications and is retrofittable to existing installations. Before beginning installation, please read and understand all of the following instructions as well as the respective exit device manufacturer's instructions.

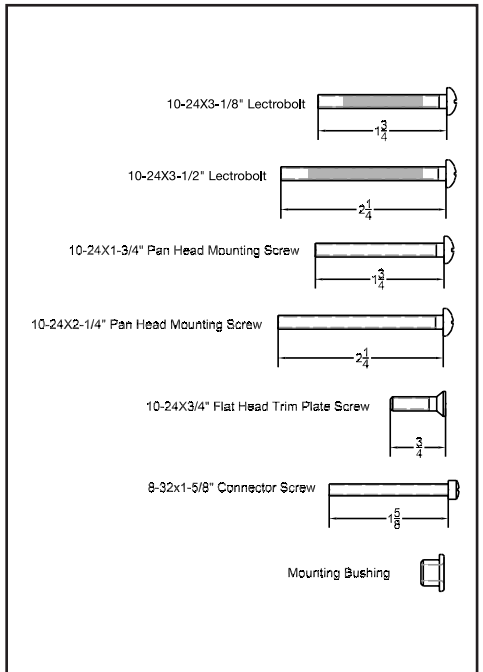

### **OPERATIONAL NOTE:**

The E-Plex Exit Trim lock is almost identical to the E-Plex 5000 Cylindrical lock with the following exceptions:

1. **Operation of the Lever** When the lock's handing is properly set, only a downward rotation of lever will actuate latch.
2. **Key Override Use** The key override differs in that rotating the key does not actuate the latch. To use the key override the key must be inserted into the cylinder and rotated counter clockwise till it stops (approximately 90 degrees) then while holding the key in this position with one hand use the other hand to rotate the lever downward to retract the latch. Once the lever has rotated a few degrees the key may be released.

### **TOOLS REQUIRED**

- Safety glasses
- Electric drill (variable speed)
- Awl or center punch
- 2 $\frac{1}{8}$ " (54 mm) hole saw pilot drill
- $\frac{3}{8}$ " (25 mm) hole saw pilot drill
- Hammer
- Phillips head screwdriver
- Small flat blade screwdriver

For technical assistance please call  
1-800-849-TECH (8324) or 336-725-1331

## A. DOOR PREPARATION - EXIT DEVICE

- A-1 For New Installations** (Existing Installations proceed to Step A-2): For new installations, all mounting hardware for the actual exit device should be acquired from the exit device supplier. All necessary hardware to mount the E-Plex exit trim is included in the box. The rim style exit device determines the location of the Vertical and Horizontal Centerlines. Follow the exit device manufacturer's directions for locating these reference lines. Draw the lines on the door such that they can be used as a reference for aligning the supplied E-Plex Exit Trim paper template in Section B. **(IMPORTANT: Before making any holes in the door make sure that the Vertical Centerline is at least 2 ¼" from the edge of the door. The E-Plex Exit Trim should not be used if the installation requires a backset less than 2 ¼". Also, if the door is a panel type make sure that the stile is wide enough to accommodate the E-Plex Outside Trim Plate. The outline of the Outside Trim Plate is shown on the paper template and may be overlaid on the centerlines for this purpose.)** If the vertical centerline and stile width are compatible with the E-Plex Exit Trim lock, complete the exit device manufacturer's door preparation instructions including locating and mounting the strike and drilling the exit device mounting holes. Do not mount the exit device until completing Section B of this manual.
- A-2 For Existing Installations** (New Installations proceed to Section B): It is important that you understand how the exit device is supposed to mount to the door to ensure that after removing the existing installation, any hardware necessary to mount the exit device back on the door, such as sex bolts, is on hand prior to beginning installation. All necessary hardware to mount the E-Plex exit trim is included in the box. Remove the existing exit device and outside trim. Care must be taken to ensure that the Vertical and Horizontal Center Lines are located as accurately as possible from the existing door preparation. Locate and draw these lines on the door such that they can be used as a reference for aligning the E-Plex Exit Trim paper template in Section B. **(IMPORTANT: Before making any holes in the door make sure that the Vertical Centerline is at least 2 ¼" from the edge of the door. The E-Plex Exit Trim should not be used if the installation requires a backset less than 2 ¼". Also, if the door is a panel type make sure that the stile is wide enough to accommodate the E-Plex Exit Trim Outside Trim Plate. The outline of the Outside Trim Plate is shown on the paper template and may be overlaid on the centerlines for this purpose.)** If the vertical centerline and stile width are compatible with the E-Plex Exit Trim, proceed to Section B of this manual.

## B. DOOR PREPARATION - E-PLEX EXIT TRIM

**B-1 For New Installations** (Existing Installations proceed to Step B-2): Place paper template (e) (supplied) onto the inside of the door and align with the Centerlines. Mark the location of the E-Plex Exit Trim mounting holes. Drill the four  $\frac{3}{8}$ " (10 mm) (b) holes through the door, then use a hole saw to cut the  $2\frac{1}{8}$ " (54 mm) (c) bore through the door at the intersection of the Vertical (a) and Horizontal (d) Centerlines. Care should be taken to drill holes perpendicular to the door face. Make sure any burrs are removed from the hole edges, and that all chips are cleaned out of the holes prior to installing hardware.

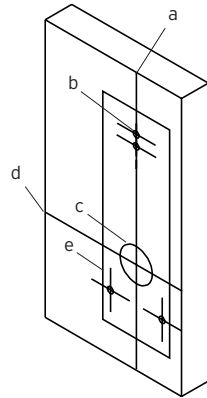

**B-2 For Existing Installations** (New Installations proceed to Section C): Doors that have an existing exit device installed might already have a through bore at the intersection of the Vertical and Horizontal Centerlines, if the existing hole is smaller than  $2\frac{1}{8}$ " (54 mm) in diameter it will need to be enlarged. Extra care should be used to ensure that the location of this hole is kept as accurate as possible in relation to the existing mounting pattern. Place paper template (supplied) onto the inside of the door aligned with the reference lines and mark the location of the E-Plex Exit Trim mounting holes. Drill the four  $\frac{3}{8}$ " (10 mm) holes through the door, then use a hole saw to cut the  $2\frac{1}{8}$ " bore through the door at the intersection of the Vertical and Horizontal Centerlines. Care should be taken to drill holes perpendicular to the door face. Make sure any burrs are removed from the hole edges, and that all chips are cleaned out of the holes prior to installing hardware.

## C. INSTALL EXIT DEVICE:

Follow the exit device manufacturer's instructions for installing the exit device onto the door.

## D. DOOR THICKNESS

The E-Plex Exit Trim Drive Unit (a) has a spring loaded tailpiece (b) and is preassembled to accommodate standard door thickness from 1 3/4" to approximately 2 1/8" for most applications. For Doors up to 2 1/4" inches it may be necessary to add a spacer (d) to increase the projection of the tailpiece. If this is required, first remove and discard the two connecting screws (c) from the Drive Unit (a). Add spacer (d), and remount using the two longer 1 5/8" (41 mm) connecting screws supplied in the thick door accessory package.

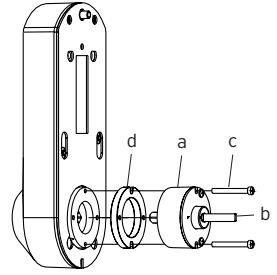

## E. ASSEMBLE OUTSIDE UNIT TO UNIVERSAL MOUNTING PLATE

Assemble the Universal Mounting Plate (a) to the Outside Unit Assembly (b) using the four 10-24 x 3/4" long screws (c) supplied in the accessory kit.

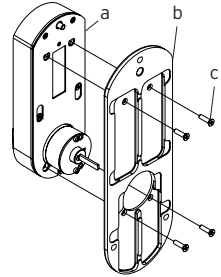

## F. LOCK HANDING

**F-1** Determine the handing of your door, from the following diagram.

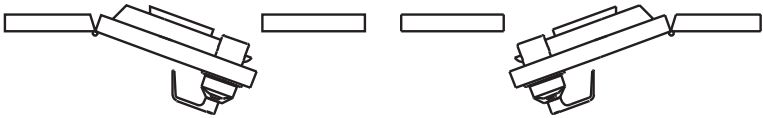

Left Hand Reverse

Right Hand Reverse

**F-2** To set the handing of the drive unit grasp the end of the tailpiece (a) with your fingers and rotate the tail piece until it stops with the indicator arrow (b) pointing at the stamped letter "LHR" for left hand reverse installations, or the stamped letter "RHR" for right hand reverse installations.

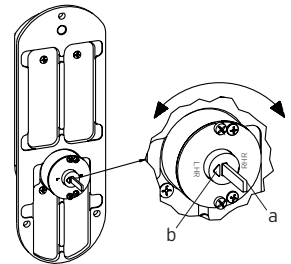

**Note:** Until engaged with the exit device, the Tailpiece (a) is free to swivel 180 degrees to facilitate handing of the lock. During shipping and preparation the position of the tailpiece may shift. The last step before mounting the lock unit is to make sure the Drive Unit is set up for proper rotation.

# KABA SIMPLEX®/E-PLEX® 5x00 SERIES LIMITED WARRANTY

---

Kaba Access Control warrants this product to be free from defects in material and workmanship under normal use and service for a period of three (3) years. Kaba Access Control will repair or replace, at our discretion, 5000 Series Locks found by Kaba Access Control analysis to be defective during this period. Our only liability, whether in tort or in contract, under this warranty is to repair or replace products that are returned to Kaba Access Control within the three (3) year warranty period.

This warranty is in lieu of and not in addition to any other warranty or condition, express or implied, including without limitation merchantability, fitness for purpose or absence of latent defects.

**ATTENTION:** This warranty does not cover problems arising out of improper installation, neglect or misuse. All warranties implied or written will be null and void if the lock is not installed properly and /or if any supplied component part is substituted with a foreign part. If the lock is used with a wall bumper, the warranty is null and void. If a doorstop is required, we recommend the use of a floor secured stop.

The environment and conditions of use determine the life of finishes on Kaba Access Control products. Finishes on Kaba Access Control products are subject to change due to wear and environmental corrosion. Kaba Access Control cannot be held responsible for the deterioration of finishes.

## **Authorization to Return Goods**

Returned merchandise will not be accepted without prior approval. Approvals and Returned Goods Authorization Numbers (RGA Numbers) for the 5000 Series are available through our Customer Service department in Winston-Salem, NC (800) 849-8324. **The serial number of a lock is required to obtain this RGA Number.** The issuance of an RGA does not imply that a credit or replacement will be issued.

The RGA number must be included on the address label when material is returned to the factory. All component parts including latches and strikes (even if not inoperative) must be included in the package with return. All merchandise must be returned prepaid and properly packaged to the address indicated.



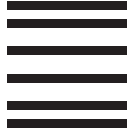

NO POSTAGE  
NECESSARY  
IF MAILED  
IN THE  
UNITED STATES

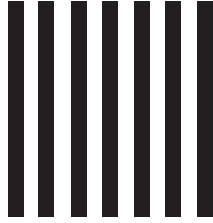

**BUSINESS REPLY MAIL**

FIRST-CLASS MAIL

PERMIT NO. 1563

WINSTON-SALEM, NC

POSTAGE WILL BE PAID BY ADDRESSEE

KABA ACCESS CONTROL  
2941 INDIANA AVENUE  
WINSTON-SALEM, NC 27199-3770



## REGISTRATION CARD

Thank you for purchasing our product. In order to protect your investment and to enable us to better serve you in the future, please fill out this registration card and return it to Kaba Access Control, or register online at [www.kabaaccess.com](http://www.kabaaccess.com).

Name \_\_\_\_\_

Position \_\_\_\_\_

Company \_\_\_\_\_

Address \_\_\_\_\_

City \_\_\_\_\_

State \_\_\_\_\_ ZIP (Postal Code) \_\_\_\_\_ Country \_\_\_\_\_

Phone \_\_\_\_\_

Email \_\_\_\_\_

Name of Dealer Purchased From \_\_\_\_\_

Date of Purchase \_\_\_\_\_

Lock Model Number \_\_\_\_\_

### This lock will be used in what type of facility?

- Commercial Building       Industrial / Manufacturing       Airport
- College/University       Government/Military       School/Educational
- Hospital/Healthcare       Other (please specify) \_\_\_\_\_

### What area is being secured with this lock? (e.g. Front Door, Common Door, Exercise Room)

This lock is:

- New Installation
- Replacing a conventional keyed lock
- Replacing a Kaba Mechanical Pushbutton Lock
- Replacing a Kaba Electronic Access Control
- Replacing a Keyless Lock other than Kaba

### How did you learn about Kaba Access Control Pushbutton Locks?

- Advertisement       Previous Use       Internet / Web       Another Use
- Locksmith       Maintenance       Training Class       Other (please specify)

What was your reason for buying this lock? \_\_\_\_\_

### Who installed your lock?

- Locksmith       Maintenance       Other \_\_\_\_\_

Check here if you would like more information on Kaba Access Control locks.



## G. CHANGING KEY-IN-LEVER CYLINDER



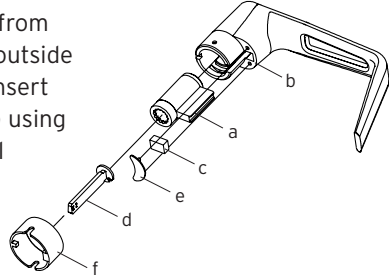

On key-in-lever models of the E-Plex, the outside lever comes preassembled with Kaba's key-in-lever cylinder (Kaba 1599). To use a different key-in-lever cylinder follow remaining steps in this section.

**G-1** Remove KIL (key-in-lever) cylinder (a) from the outside lever (b) by removing the outside lever sleeve (f). Remove the cylinder insert (e) and the rubber cylinder retainer (c) using a small flat blade screw driver or small needle nose pliers.



**G-2** Determine the proper tailpiece (d) from the chart below for your KIL cylinder.

**You must use a Kaba tailpiece. The K 2 tailpiece is preassembled with the Kaba 1599.**

TAILPIECE	KIL CYLINDER
 <b>K1</b>	Abloy 5277, Abloy 5477, Assa 65691, Kaba 1539, Kaba Gemini 4730
 <b>K2</b>	Assa 65611, Australian: Kaba experT 107K5 & Boyd KC286, Corbin-Russwin 2000-03, Kaba 1599, Schlage 23-001, Schlage Primus 20-760, Kaba Peaks 1099
 <b>K3</b>	Medeco 20W200H1
 <b>K4</b>	Arrow C100, Sargent 10 LINE
 <b>K5</b>	Marks

**G-3** Assemble the required tailpiece (d) (supplied) with your KIL cylinder. **All tailpieces must be installed vertically (with key removed from cylinder) for proper installation.**

**G-4** Insert the KIL cylinder into the outside lever (b) and secure it with the cylinder retainer (c) and the cylinder insert (e) until the KIL cylinder is snug and unable to move freely.

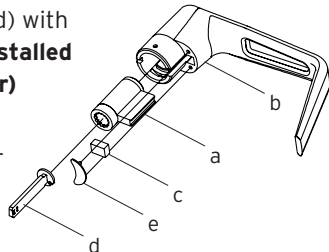

## H. INSTALLING / REMOVING OUTSIDE LEVER

(Key-In-Lever models only, for interchangeable and removable cores proceed to section I)

**Note:** Installing levers to the unit assemblies before mounting the unit assemblies may ease initial installation.

- H-1** Make certain the lever catch is up as shown (c). Position the lever sleeve (f) tab correctly with the respective notch on the lever. The lock comes shipped with the lever sleeve already installed in the lock housing. When installing lever, ensure it is oriented to engage the lever sleeve to accommodate desired lock handing as shown.
- H-2** Insert one of the (supplied) keys (a) into the outside lever (b) and rotate key counterclockwise 45 degrees.
- H-3** Insert the outside lever until it is flush to the outside unit assembly. Secure the outside lever by rotating the key clockwise 45 degrees to horizontal position. Remove key.

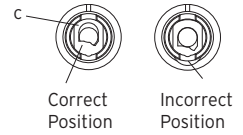

KIL Lever Sleeve

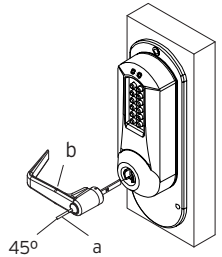
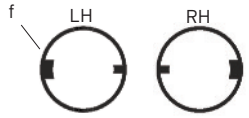

**Note:** To remove the outside lever from the outside unit assembly, follow the steps below.

- H-4** Insert one of the (supplied) keys (a) into the outside lever (b) and rotate it counterclockwise 45 degrees. Insert release tool (d) into the small hole (e) under lever as shown. Gently push lever catch up until it clicks. Remove tool, then remove outside lever (b).

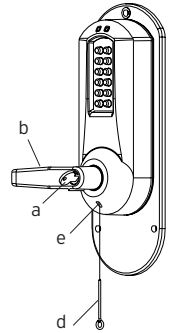

## I. INSTALLING / REMOVING OUTSIDE LEVER

(Interchangeable / Removable Core Models)

**Note:** Installing levers to the unit assemblies before mounting the unit assemblies may ease initial installation.

- I-1** Make certain the lever catch is up as shown (c). Position the lever sleeve (f) tab correctly with the respective notch on the lever. The lock comes shipped with the lever sleeve already installed in the lock housing. When installing lever, ensure it is oriented to engage the lever sleeve to accommodate desired lock handing as shown.

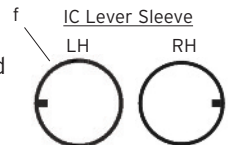
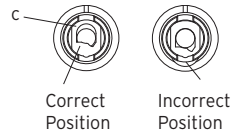

**Note:** For all interchangeable/removable cylinders except ASSA/Medeco/Yale, proceed to section I-2. For ASSA/Medeco/Yale cylinders, skip to section I-5.

**I-2** Insert the outside lever (b) until it is flush to the outside unit assembly (a). To secure the outside lever, insert the release tool (d) (or screwdriver) into the outside lever as shown, and slide the lever catch down until it clicks. Make certain lever is attached before installing the core.

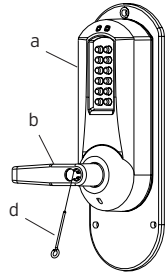

**I-3** Insert the supplied tailpiece (e) vertically into the outside lever (b) as shown. Make certain that you rotate the tailpiece so that it will align with the interchangeable core. For screw cap type cylinders (Schlage) (g), the tailpiece must be assembled to the cylinder first (vertical position). Insert the interchangeable core into the outside lever. Remove control key.

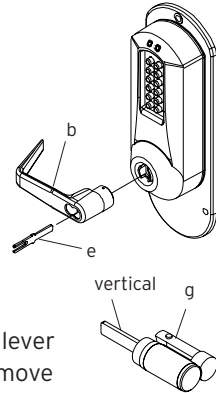

**Note:** To remove the outside lever from the outside unit assembly, follow the steps below.

**I-4** Remove the interchangeable core (g). Then remove the tailpiece (e).

**Note:** You may want to use needle nose pliers for some tailpieces.

Insert the release tool (d) into the small hole (f) under lever as shown. Gently push lever catch up until it clicks. Remove tool, then remove outside lever (b).

**I-5** For ASSA/Medeco/Yale interchangeable/removable cylinders, the tailpiece must be prepped for the desired length before installation.

**When using a Yale cylinder on a cylindrical latch application, measure the door thickness of the intended application.**

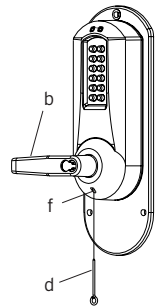

**I-6** Notice the score marks on the flat portion of the ASSA/Medeco/Yale tailpiece. Using the diagram below, locate the score mark on your tailpiece that matches your cylinder prep for the intended application, and break the tailpiece off accordingly.

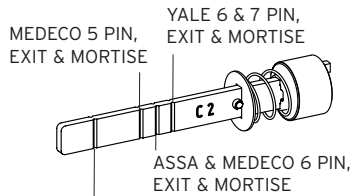

YALE 6 & 7 PIN,  
CYLINDRICAL - THIN DOOR  
(1 3/8" (35 mm) to 1 1/2" (38 mm))  
(DO NOT SHORTEN TAILPIECE -  
For 1 5/8" (41 mm) to 2 1/4" (57 mm))

ASSA/MEDECO 5, 6 & 7 PIN,  
CYLINDRICAL - DO NOT SHORTEN TAILPIECE

- I-7 Using two pairs of pliers, break the tailpiece to the desired length of the intended application by holding one pair of pliers on the good side of the score mark and a second pair on the other side of the score mark. Slowly move the 2nd pair of pliers up and down until the unneeded portion of the tailpiece breaks free.
- I-8 Insert the Medeco tailpiece (e) vertically into the outside lever as shown. Make certain that you rotate the tailpiece slightly so that it will align with the interchangeable/removable cylinder. Insert the interchangeable/removable cylinder into the outside lever.

**Note:** To remove the outside lever from the outside unit assembly, follow steps below.

- I-9 Remove the interchangeable/removable cylinder. Then remove the tailpiece (e).

**Note:** You may want to use needle nose pliers for some tailpieces.

- I-10 Insert the lever release tool (d) into the small hole (f) under lever as shown. Gently push lever catch up until it clicks. Remove tool, then remove outside lever (a).

## J. INSTALLING E5x00 EXIT TRIM

**Note:** Prior to mounting the lock, ensure the handing is set correctly as the tailpiece may have shifted during handling (see section F).

**Warning:** If using a power drill, be careful not to over-tighten as this could cause damage to the mounting screws and threads.

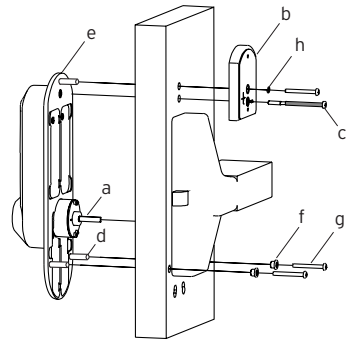

- J-1 Guide the Unit Assembly so the Tailpiece (a) engages the vertical slot in the hub of the exit device. The key override may be utilized to test the operation to make sure that the tailpiece is engaged with the exit device hub before fastening assembly to the door. The outside unit assembly must be held in place by hand until fastened with LectroBolt.
- J-2 Place the Battery Mounting Plate (b) on the door such that the red collar is inside the lower of the top two  $\frac{3}{8}$ " diameter holes and hold in place by hand until fastened with LectroBolt.
- J-3 Select the LectroBolt (c)(screw with red sleeve) length that corresponds to the correct door thickness: use the 3" screw for thickness range from  $1\frac{3}{4}$ " to 2", for door thickness of  $2\frac{1}{8}$ " to  $2\frac{1}{4}$ " use the  $3\frac{1}{8}$ " long LectroBolt included in the Thick Door Accessory pack.

- J-4** Insert the LectroBolt through the red battery mounting plate hole marked with the lightning bolt symbol. For now, only partially tighten the LectroBolt enough to hold the Outside Unit assembly and the battery mounting plate in place on the door.
- J-5** Insert the two Mounting Bushings (f) into the lower two holes on the inside of the door.
- J-6** Select the proper length Mounting Screws (g) for the door thickness: use the 1 3/4" screw for door thickness range from 2 1/4" to 2", for door thickness range of 2 1/8" to 2 1/4" use the 2 1/4" long screws included in the thick door accessory pack. Insert two of the Mounting Screws into two lower mounting holes and tighten securely.
- J-7** Place the supplied lock washer (h) on the remaining mounting screw, and insert in to the uppermost mounting hole and fasten securely to the sex bolt.
- J-8 Important:** Once the regular mounting screws have been tightened finish tightening the LectroBolt™ to secure the lock to the door.

**Note:** Do not shut door until installing batteries and testing operation as outlined in the following two sections.

## K. INSTALLING THE BATTERY PACK AND COVER / CHANGING BATTERIES

- K-1** To Install the Battery Pack (a) and cover (b), snap the cable connector (c) onto the top of the battery pack. Then place the battery pack into the cover with the terminals at the top. Put the two security screws (d) into the cover and fasten to the battery mounting plate with the security screw wrench (e). **Important:** Do not shut door until testing operations as directed in section L.

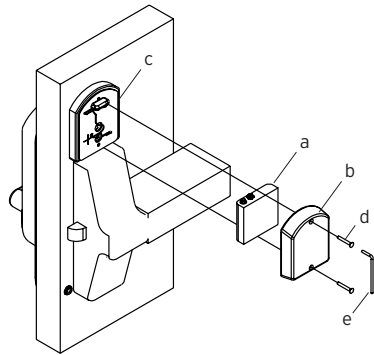

**Caution:** Over-tightening these screws could strip the threads in the housing or crack the cover.

**Warning:** If the lock's date and time have been set, and then power is removed from the lock for more than 2 minutes, the lock's current date and time will need to be set again. Please refer to Lock Operations Manual for instructions on setting the date and time.

- K-2** To change batteries remove the two screws (d) from the battery cover (d) using the security screw wrench (e) provided with your lock.



**Warning:** Do not install a 9V battery. This EPLEX lock operates on 4 alkaline **only** AA batteries (6V). A 9V will ruin the electronics in the lock and void the warranty.

**K-3** Remove the four depleted batteries and install four new alkaline (**only**) AA batteries. **Ensure that each battery is installed in the proper direction as shown at the battery location in the battery holder (a).**

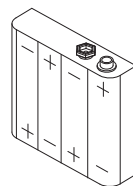

**K-4** Reconnect the battery cable. Place the battery holder into the cover. Screw the cover back onto the battery mounting plate, and ensure the cable is not trapped under the edge of the cover.

**Caution:** Over-tightening these screws could strip the threads in the housing or crack the cover.

## L. TESTING THE OPERATION OF THE LOCK

- L-1** Depress the pushbar of the exit device and hold. Ensure that the latch is fully retracted. Release the push pad; the latch should return to the fully extended position.
- L-2** Enter the factory set combination: 1,2,3,4,5,6,7,8. You see a green light and hear a tone as you push each button. When the lock opens, you will briefly hear the sound of an electric motor.
- L-3** Rotate the outside lever downward and hold. Ensure that the latch is retracted sufficiently to clear the strike. Release the Outside Lever; the latch should be fully extended.
- L-4** Allow a few seconds for the lock to re-lock (sound of motor is heard), and then rotate the Outside Lever. The latch should not retract.
- L-5** Insert one of the supplied keys into the outside lever. Rotate key counter clockwise till it stops (approximately 90 degrees) then while holding the key in this position with one hand, then use the other hand to rotate the lever downward till it stops and hold (once the lever has rotated a few degrees the key may be released). Ensure that the latch has retracted sufficiently to clear the strike. Release the lever once more and ensure that the latch is fully extended.

**Note:** Refer to the Operations Manual to set up lock operation.

## **M. PROGRAMMING AND SOFTWARE SETTINGS:**

- M-1** You must change the master Code from the factory default to another code to program the lock. For further information on how to manually program the E-Plex 3x00/5x00 Series Models, refer to the companion “E-Plex 3x00/5x00 Operation Manual.” Software is required to program the E3200/E5200 Series Locks.
- M-2** When configuring the E3000/E5000 Series Locks using the optional Standard Software, choose the box that contains “Entry Lock with Passage (Cylindrical or Mortise without Deadbolt)” during lock setup.
- M-3** When configuring the E3200/3700 and E5200/E5700 Series Locks using the Enerprise Software, select the appropriate lock type during lock setup.





Kaba Access Control  
2941 Indiana Avenue  
Winston-Salem, NC 27105 USA  
Tel: (800) 849-8324 (336) 725-1331  
Fax: (800) 346-9640 (336) 725-3269

[www.kabaaccess.com](http://www.kabaaccess.com)

PKG3055 0912