

VIKING

TECHNICAL Practice

TELECOM SOLUTIONS FOR THE 21ST CENTURY

CTG-1

Clock Controlled Tone Generator

April 24, 2012

Add Time Controlled Alert Tones and Emergency Tones to Your Paging System



Viking's model **CTG-1** is a clock controlled tone generator designed to provide accurately timed bong alert tones or buzzer alert tone sounds over an existing paging system.

The **CTG-1** can be programmed to output single, double or triple alert tones with up to 128 events in a 24 hour period. These bong/buzzer sounds are ideal for indicating the start and end of shifts, break times, lunch periods, etc. for factories, schools, or any business

requiring an audible indication of specified times. Each day of the week can be programmed to either on or off, allowing you to turn off the alert tones during specific days of the week (weekends, etc.)

The **CTG-1** has three contact closure inputs for triggering an emergency siren, evacuation signal or a doorbell sound.

Features

- Accurate 24 hour digital time clock displays hours and minutes
- User programmable 24 hour, 128 event timer
- Programmable day of week on/off feature
- Programmable single, double or triple alert tone output (selectable bong or buzzer)
- Three contact closure controlled sounds:
 - 1) Emergency siren (yelp) sound
 - 2) Temporal (slow whoop) evacuation signal
*NFPA/ANSI compliant when used with supporting equipment
 - 3) Doorbell (chime) sound
- Volume controllable, 600 ohm line level audio output
- Non-volatile programming memory
- Battery backup for maintaining clock time with factory installed 9V NiMh rechargeable battery
- Two sets of DPDT relay contacts for muting paging or background music during alert tones
- Switchable 50/60 Hz operation

Applications

- Signal the beginning and end of class periods, breaks, and lunch periods for schools
- Signal the beginning and end of shifts, breaks, and lunch periods for factories and other businesses
- Provides a doorbell and/or alarm sounds over an existing paging system, for such applications as door entry, fire, severe weather, etc.
- Use with Viking's **DVA-2WA** to provide timed messages (**DOD# 110**)

Specifications

Power: 120V AC/13.8V AC 1.25A UL listed adapter provided
Dimensions: 133mm x 91mm x 44mm (5.25" x 3.6" x 1.75")
Weight: 0.9 Kg (2 lbs)
Environmental: 0°C to 32°C (32°F to 90°F) with 5% to 95% non-condensing humidity
Connections: 12 position cage clamp terminal strip
Battery Backup: 9V NiMh rechargeable battery (factory installed) maintains clock time for over 8 hours
Time Base: 50/60Hz AC power line
Time Base Battery Backup Accuracy: +/- 50 ppm
Audio Output: 600 ohm with volume adjust potentiometer, maximum level = 17 dBm/5.4Vrms across 600 ohm load
Relay Output: DPDT rated 125V AC, 30 W (resistive load)

Phone... 715.386.8861

IF YOU HAVE A PROBLEM WITH A VIKING PRODUCT, PLEASE CONTACT: VIKING TECHNICAL SUPPORT AT (715) 386-8666

Our Technical Support Department is available for assistance Monday 8am - 4pm and Tuesday through Friday 8am - 5pm central time. So that we can give you better service, before you call please:

1. Know the model number, the serial number and what software version you have (see serial label).
2. Have your Technical Practice in front of you.
3. It is best if you are on site.

RETURNING PRODUCT FOR REPAIR

The following procedure is for equipment that needs repair:

1. Customer must contact Viking's Technical Support Department at 715-386-8666 to obtain a Return Authorization (RA) number. The customer MUST have a complete description of the problem, with all pertinent information regarding the defect, such as options set, conditions, symptoms, methods to duplicate problem, frequency of failure, etc.
2. Packing: Return equipment in original box or in proper packing so that damage will not occur while in transit. Static sensitive equipment such as a circuit board should be in an anti-static bag, sandwiched between foam and individually boxed. All equipment should be wrapped to avoid packing material lodging in or sticking to the equipment. Include ALL parts of the equipment. C.O.D. or freight collect shipments cannot be accepted. Ship cartons prepaid to:
Viking Electronics, 1531 Industrial Street, Hudson, WI 54016
3. Return shipping address: Be sure to include your return shipping address inside the box. We cannot ship to a PO Box.
4. RA number on carton: In large printing, write the R.A. number on the outside of each carton being returned.

RETURNING PRODUCT FOR EXCHANGE

The following procedure is for equipment that has failed out-of-box (within 10 days of purchase):

1. Customer must contact Viking's Technical Support at 715-386-8666 to determine possible causes for the problem. The customer MUST be able to step through recommended tests for diagnosis.
2. If the Technical Support Product Specialist determines that the equipment is defective based on the customer's input and troubleshooting, a Return Authorization (R.A.) number will be issued. This number is valid for fourteen (14) calendar days from the date of issue.
3. After obtaining the R.A. number, return the approved equipment to your distributor, referencing the R.A. number. Your distributor will then replace the product over the counter at no charge. The distributor will then return the product to Viking using the same R.A. number.
4. **The distributor will NOT exchange this product without first obtaining the R.A. number from you. If you haven't followed the steps listed in 1, 2 and 3, be aware that you will have to pay a restocking charge.**

LIMITED WARRANTY

Viking warrants its products to be free from defects in the workmanship or materials, under normal use and service, for a period of one year from the date of purchase from any authorized Viking distributor or 18 months from the date manufactured, whichever ever is greater. If at any time during the warranty period, the product is deemed defective or malfunctions, return the product to Viking Electronics, Inc., 1531 Industrial Street, Hudson, WI., 54016. Customer must contact Viking's Technical Support Department at 715-386-8666 to obtain a Return Authorization (R.A.) number.

This warranty does not cover any damage to the product due to lightning, over voltage, accident, misuse, abuse, negligence or any damage caused by use of the product by the purchaser or others. This warranty does not cover non-EWP products that have been exposed to wet or corrosive environments.

NO OTHER WARRANTIES. VIKING MAKES NO WARRANTIES RELATING TO ITS PRODUCTS OTHER THAN AS DESCRIBED ABOVE AND DISCLAIMS ANY EXPRESS OR IMPLIED WARRANTIES OR MERCHANTABILITY OR FITNESS FOR ANY PARTICULAR PURPOSE.

EXCLUSION OF CONSEQUENTIAL DAMAGES. VIKING SHALL NOT, UNDER ANY CIRCUMSTANCES, BE LIABLE TO PURCHASER, OR ANY OTHER PARTY, FOR CONSEQUENTIAL, INCIDENTAL, SPECIAL OR EXEMPLARY DAMAGES ARISING OUT OF OR RELATED TO THE SALE OR USE OF THE PRODUCT SOLD HEREUNDER.

EXCLUSIVE REMEDY AND LIMITATION OF LIABILITY. WHETHER IN AN ACTION BASED ON CONTRACT, TORT (INCLUDING NEGLIGENCE OR STRICT LIABILITY) OR ANY OTHER LEGAL THEORY, ANY LIABILITY OF VIKING SHALL BE LIMITED TO REPAIR OR REPLACEMENT OF THE PRODUCT, OR AT VIKING'S OPTION, REFUND OF THE PURCHASE PRICE AS THE EXCLUSIVE REMEDY AND ANY LIABILITY OF VIKING SHALL BE SO LIMITED.

IT IS EXPRESSLY UNDERSTOOD AND AGREED THAT EACH AND EVERY PROVISION OF THIS AGREEMENT WHICH PROVIDES FOR DISCLAIMER OF WARRANTIES, EXCLUSION OF CONSEQUENTIAL DAMAGES, AND EXCLUSIVE REMEDY AND LIMITATION OF LIABILITY, ARE SEVERABLE FROM ANY OTHER PROVISION AND EACH PROVISION IS A SEPARABLE AND INDEPENDENT ELEMENT OF RISK ALLOCATION AND IS INTENDED TO BE ENFORCED AS SUCH.

FCC REQUIREMENTS

This equipment complies with Part 68 of the FCC rules and the requirements adopted by the ACTA. Inside the front panel of this equipment is a label that contains, among other information, a product identifier in the format US:AAAEQ##TXXXX. If requested, this number must be provided to the telephone company.

The REN is used to determine the number of devices that may be connected to a telephone line. Excessive REN's on a telephone line may result in the devices not ringing in response to an incoming call. In most but not all areas, the sum of the REN's should not exceed five (5.0). To be certain of the number of devices that may be connected to a line, as determined by the total REN's, contact the local telephone company. For products approved after July 23, 2001, the REN for this product is part of the product identifier that has the format US:AAAEQ##TXXXX. The digits represented by ## are the REN without a decimal point (e.g., 03 is a REN of 0.3). For earlier products, the REN is separately shown on the label.

The plug used to connect this equipment to the premises wiring and telephone network must comply with the applicable FCC Part 68 rules and requirements adopted by the ACTA. If your home has specially wired alarm equipment connected to the telephone line, ensure the installation of this CTG-1 does not disable your alarm equipment. If you have questions about what will disable alarm equipment, consult your telephone company or a qualified installer.

If the CTG-1 causes harm to the telephone network, the telephone company will notify you in advance that temporary discontinuance of service may be required. But if advance notice isn't practical, the telephone company will notify the customer as soon as possible. Also, you will be advised of your right to file a complaint with the FCC if you believe it is necessary.

The telephone company may make changes in its facilities, equipment, operations, or procedures that could affect the operation of the equipment. If this happens, the telephone company will provide advance notice in order for you to make

the necessary modifications to maintain uninterrupted service.

If trouble is experienced with the CTG-1, for repair or warranty information, please contact:

Viking Electronics, Inc., 1531 Industrial Street, Hudson, WI 54016 (715) 386-8666

If the equipment is causing harm to the telephone network, the telephone company may request that you disconnect the equipment until the problem is resolved.

Connection to Party Line Service is subject to State Tariffs. Contact the state public utility commission, public service commission or corporation commission for information.

WHEN PROGRAMMING EMERGENCY NUMBERS AND (OR) MAKING TEST CALLS TO EMERGENCY NUMBERS:

Remain on the line and briefly explain to the dispatcher the reason for the call. Perform such activities in the off-peak hours, such as early morning or late evenings.

It is recommended that the customer install an AC surge arrester in the AC outlet to which this device is connected. This is to avoid damaging the equipment caused by local lightning strikes and other electrical surges.

PART 15 LIMITATIONS

This equipment has been tested and found to comply with the limits for a Class A digital device, pursuant to Part 15 of the FCC Rules. These limits are designed to provide reasonable protection against harmful interference when the equipment is operated in a commercial environment. This equipment generates, uses, and can radiate radio frequency energy and, if not installed and used in accordance with the instruction manual, may cause harmful interference to radio communications. Operation of this equipment in a residential area is likely to cause harmful interference in which case the user will be required to correct the interference at his own expense.

Features Overview

Mode Button: Press to place the CTG-1 in the Lock, Set Time, Set Day, Set Events or Review/Cancel modes.

Clock and Event Time Setting Buttons: Press the + or -/CANCEL buttons to increase or decrease time. The -/CANCEL switch is also used to cancel an alert tone event when reviewing programming.

Display: Shows clock, event time and mode settings.

DIP Switches and Shunts: See Programming section J.

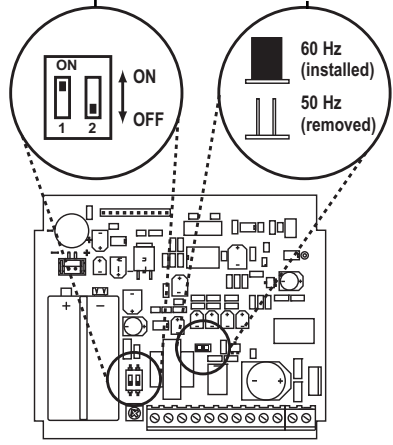
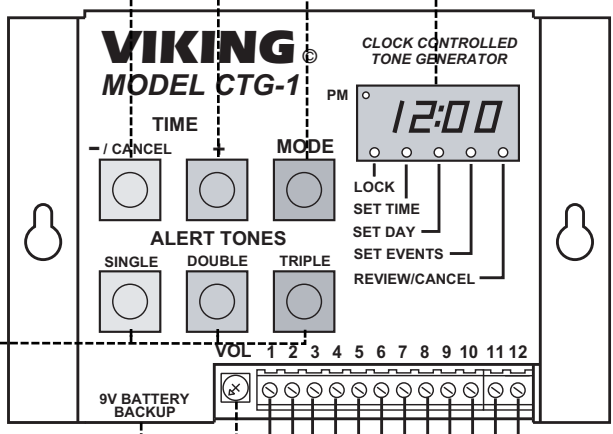

Alert Tones Programming Buttons: After setting an event time, press **SINGLE**, **DOUBLE** or **TRIPLE** to program 1, 2 or 3 alert bongs/buzzer sounds for that event time.

Secondary Button Functions While in the SET DAY Mode: The **SINGLE** button is used to select between day (1-7) or on/off. The **DOUBLE** button is used as a one time setup to program today's day of the week.

9V Battery Backup Connection: A standard rechargeable (NiMh) 9V battery is installed to maintain the clock time during power outages.

CTG-1 Output Volume Control: Turn clockwise to increase volume of alert bongs/buzzer sounds, emergency and door bell (chime) sounds (see Installation section).

- 12: Common
- 11: Emergency Siren (Yelp): Continuous while shorted to pin 12 (common).
- 10: Evacuation Sound (Temporal Slow Whoop): Continuous while shorted to pin 12 (common).
- 9: Doorbell Chime Sound (Ding Dong): One chime per closure.
- 8: N.O. } Relay Contact
- 7: COM } Relay Contact
- 6: N.C. }
- 5: N.O. } Relay Contact
- 4: COM } Relay Contact
- 3: N.C. }
- 1 & 2: 600 Ohm Audio Out Pair: Line level output, connect to input of paging amplifier.

*** Note:** When the buzzer alert tone is programmed, a double or triple programmed event will be sounded twice, approximately three seconds apart.

Installation

Connect the **CTG-1** between your phone system and your paging amplifier as shown in the diagram below. The factory installed rechargeable 9V battery will maintain the clock time for over 8 hours.

IMPORTANT: The **CTG-1** leaves the factory with the battery backup DIP switch turned **OFF** to avoid discharging the battery during shipment. The battery backup DIP switch **MUST** be set to **ON** (see Programming section J) to maintain clock time during a power outage.

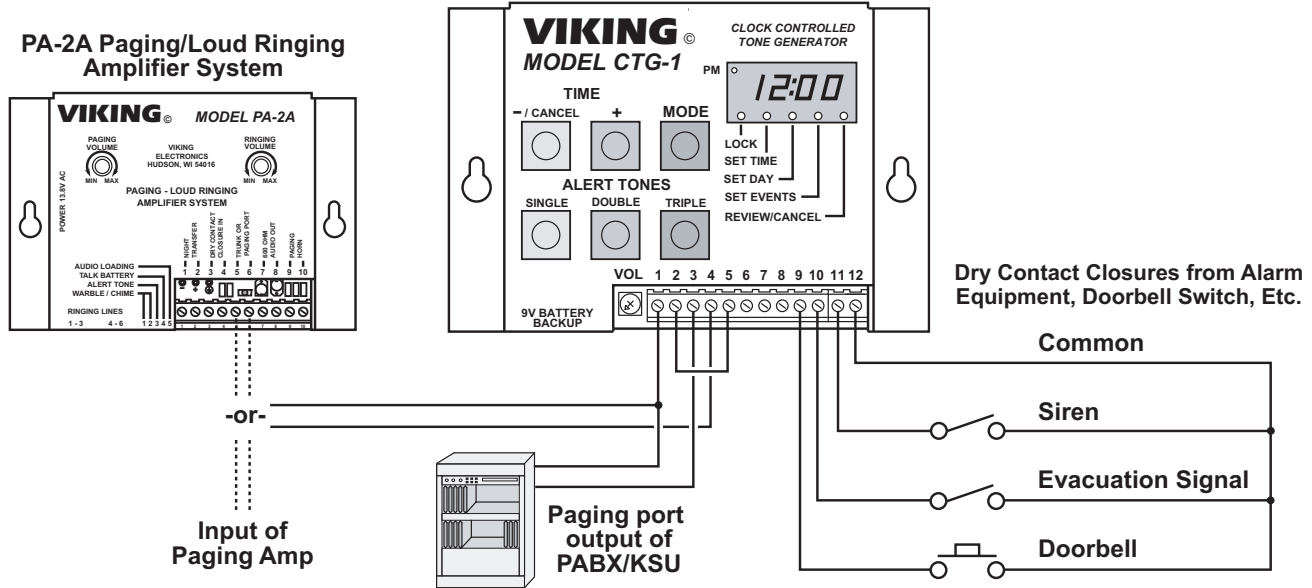

Programming

A. Setting the Clock Time

Step 1.	Press the MODE button repeatedly until the SET TIME indicator lights.
Step 2.	Increase or decrease the clock time by pressing the + or -/CANCEL button until the desired time is displayed.
Step 3.	Leave the set time mode by pressing the MODE button.

Note: Either the **+** or **-/CANCEL** button **MUST** be pressed at least once prior to leaving the set time mode. The clock will then start to run the moment you leave the set time mode, allowing you to synchronize the **CTG-1** with your building clocks.

B. Setting the Day of the Week

Note: This step is only required if you want to turn off the Alert Tones on certain days of the week.

Step 1.	Press the MODE button repeatedly until the SET DAY indicator lights.
Step 2.	A flashing "A" indicates all 7 days of the week are "on" and today's day has not been set. The day of the week has already been set if a flashing number (1-7) and "on" or "of" are displayed.
Step 3.	Select today's day of the week using the TIME (+ and -/CANCEL) buttons. As a general rule, Sunday is day 1 and Saturday is day 7. When today's day of the week is flashing on the display, set it by pressing the DOUBLE alert tone button. Today's day number and "on" will now be displayed.

Note: The day of the week setting and turning the alert tones off on specific days of the week is a one time set up and does not need to be reset unless you have experienced a brown out long enough to discharge the 9V battery backup (approximately 8 hours). To reset the day of the week and turn off tones on specific days of the week, you must power down the **CTG-1**, set DIP switch 1 to **OFF**, power up the **CTG-1** and repeat steps 1-3 above. If you had alert tones turned off on specific days of the week, repeat steps 1-4 in section C. When finished, set DIP switch 1 back to **ON**.

C. Turning the Alert Tones On/Off for Specific Days of the Week

Step 1.	Press the MODE button repeatedly until the SET DAY indicator lights. The current day of the week and “ on ” or “ of ” will be displayed. “ on ” = alert tones are ON and “ of ” = alert tones are OFF for that day of the week.
Step 2.	Pressing the SINGLE button will toggle between flashing the day of the week and flashing “ on ” or “ of ”. The flashing portion of the display is the section that can be changed.
Step 3.	With the day of the week flashing, use the TIME (+ and -/CANCEL) buttons to select the day of the week you would like to set to ON or OFF. When the correct day of the week is displayed, press the SINGLE button to flash “ on ” or “ of ”. The day can then be set to ON or OFF by using the TIME (+ and -/CANCEL) buttons.
Step 4.	Review your day of the week programming by pressing the SINGLE button until the weekday (1-7) is flashing, then increment through each day of the week with the TIME (+) button and monitor each day for its on or off setting. Exit the SET DAY mode by simply pressing the MODE button.

D. Setting Timed Alert Tones

Step 1.	Press the MODE button repeatedly until the SET EVENTS indicator lights.
Step 2.	Increase or decrease the event time by pressing the TIME (+ or -/CANCEL) button until the desired time is shown.
Step 3.	Move DIP switch 2 to OFF for bong alert tones or ON for buzzer alert tones (see Programming section J).
Step 4.	Press one of the single, double, or triple ALERT TONES buttons to program the number of alert tones you wish to output at the specific event time. A single, double, or triple confirmation beep should be heard.
Step 5.	Repeat steps 2-4 for the remainder of your scheduled events.

Note: If more than 128 events have been entered, a long beep will be heard indicating that the event memory is full.

E. Reviewing and/or Cancelling Timed Alert Tones

Step 1.	Press the MODE button repeatedly until the REVIEW/CANCEL indicator lights.
Step 2.	Press one of the ALERT TONES buttons (single, double, or triple) repeatedly to rotate through the event times associated with that alert tone button. A red LED at the bottom right corner of the time display will light to indicate a buzzer event time (versus a bong event). Note: <i>Event times are stored in the order of programming, not chronologically.</i>
Step 3.	Press the -/CANCEL button to permanently cancel an event tone. A single acknowledgement tone will be heard. The next consecutive event for that specific alert tone will then be displayed.
Step 4.	Repeat steps 2-3 as needed to remove the events to be cancelled.
Step 5.	When all events for a given alert tone have been cancelled, the display shows three dashes (- - -).

F. Adjusting Output Volume

Step 1.	Short pins 9 and 12 together momentarily. The doorbell sound will then chime once.
Step 2.	Adjust the volume control potentiometer (see Installation).
Step 3.	Repeat steps 1-2 until the desired volume is achieved.

G. Activating Contact Closure Alarm Tones

To activate different sounds, short the corresponding pins with a dry contact closure as shown right (see **Installation**, section A).

Note: *The evacuation sound and siren will be repeated continuously, as long as the closures are maintained.*

Sound	Short Pins...
Doorbell (Ding Dong)	...9 to 12
Evacuation Sound (Slow Whoop)	...10 to 12
Siren (Yelp)	...11 to 12

H. Locking the CTG-1 for Operation

When finished programming, press the **MODE** button until the **LOCK** indicator lights. In the lock mode, the time and alert tone keys will be disabled and the current time will be displayed with the colon flashing once per second.

I. Clearing the Alert Tone Memory

Turn DIP switch **1** **OFF**. Unplug the **CTG-1** from power. Pause a few seconds and then plug the **CTG-1** back in. Push the **CANCEL** and **SINGLE** buttons at the same time and release them. Repeat, and after releasing the buttons the second time a long beep will be heard indicating that the **CTG-1**'s memory has been cleared. Turn DIP switch **1** back **ON** to enable battery backup.

Note: After completing this procedure, it will be necessary to reset the clock time (see **Programming** section **A**), and if enabled, the day of the week (see **Programming** section **B**) and alert tones on/off (see **Programming** section **C**).

J. DIP Switch and Shunt Settings

Switch	Position	Description
1	OFF	Battery backup disabled
1	ON	Battery backup enabled
2	OFF	Bong alert tones (factory setting)
2	ON	Buzzer alert tones

Shunt Position	Description
Installed	60 Hz power line frequency (factory setting)
Removed	50 Hz power line frequency

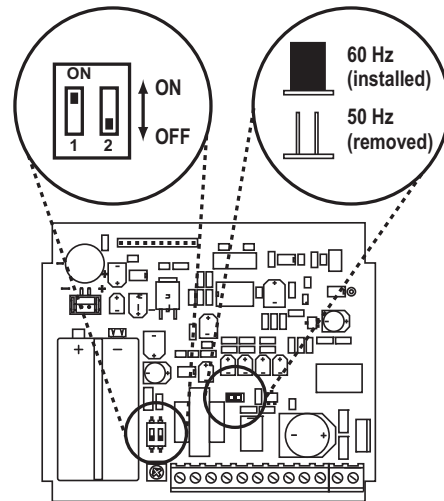

Internal View of the CTG-1

K. Changing the Power Line Frequency Setting

Unplug the **CTG-1** from power and turn DIP switch **1** **OFF**. Remove the shunt as shown in the diagram above to change from 60 Hz to 50 Hz, or replace it to change from 50 Hz operation to 60 Hz. Power the **CTG-1** back up and turn DIP switch **1** **ON**. Set the **CTG-1** to the current time.

Operation

When the clock time matches an event time and that day is set to “**ON**” or “**A**”, the **CTG-1** will output the corresponding single, double or triple bong or buzzer alert tone. The **CTG-1** will also open terminals 3 and 4 (normally closed) and close terminals 4 and 5 (normally open), allowing the capability of switching out the audio from the phone system and switching in the alert tone from the **CTG-1**. Similarly, while a contact closure is made shorting pins 9, 10 or 11 to pin 12, the **CTG-1** will output the corresponding sound (doorbell, evacuation signal or emergency siren). In the case of the siren or evacuation signal, terminals 3 and 4 will open, and terminals 4 and 5 will close and the sound will continue for the duration of the contact closure input. Terminals 3, 4 and 5 will return to their normal states at the end of each doorbell tone.

Note: Terminals 6, 7 and 8 will operate the same as terminals 3, 4 and 5 but are electronically isolated from terminals 3, 4 and 5 for switching a separate device.

IMPORTANT: While operating, the **CTG-1** continuously checks the event time information stored in memory. If a problem is detected, the **CTG-1** displays “**EEE**” to indicate an error. Normal clock function continues in the background. To clear the error, press any button and the **CTG-1** will return to normal operation. If the “**EEE**” display persists, contact Viking Technical Support at 715-386-8666.

Sound Output Specifications

A. Bong Alert Tone

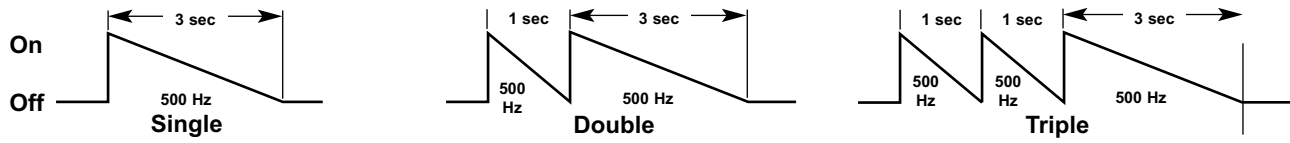

B. Buzzer Alert Tone

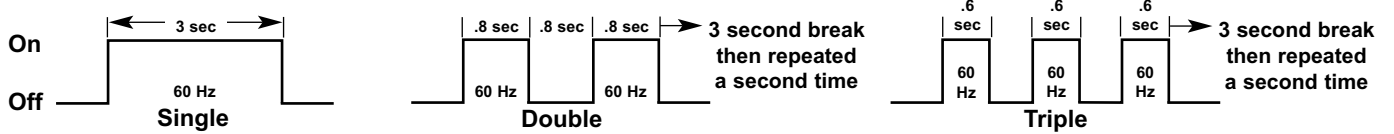

C. Doorbell (Ding Dong)

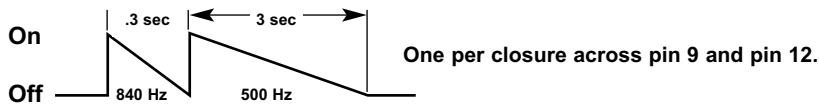

D. Evacuation Signal (Temporal Slow Whoop)

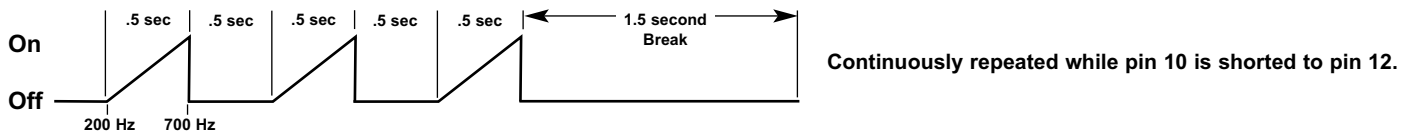

E. Siren (Yelp)

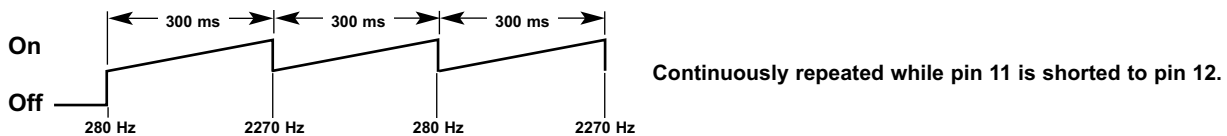

Other Applications

Use Viking's **DVA-2WA** Digital Voice Announcer (**DOD# 110**) in conjunction with a **CTG-1** to provide time activated promotional voice messages over an existing paging system. The **CTG-1** will be used only to provide time activated contact closures to the **DVA-2WA** for initiating multiple (up to 7.5 minutes total length) promotional messages. **Note:** *It is recommended that a UPS (uninterruptible power source) be used to maintain the proper message order in the **DVA-2WA** during a power outage.*

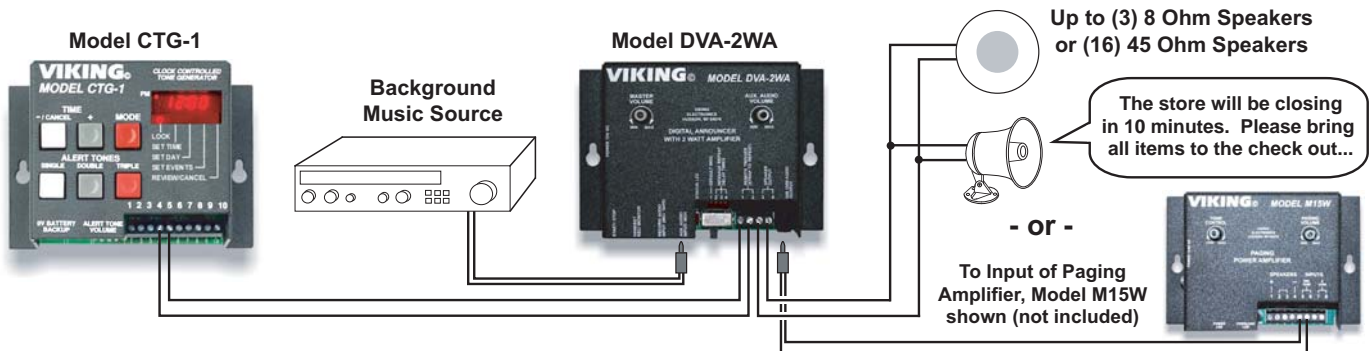

Product Support Line...715.386.8666

Fax Back Line...715.386.4345

Due to the dynamic nature of the product design, the information contained in this document is subject to change without notice. Viking Electronics, and its affiliates and/or subsidiaries assume no responsibility for errors and omissions contained in this information. Revisions of this document or new editions of it may be issued to incorporate such changes.