

**Corbin
Russwin** 

ASSA ABLOY

CL3800 Series

Standard-Duty Key-in-Lever Locksets



ASSA ABLOY, the global leader
in door opening solutions

Applications

CL3800

Index

Applications	2
Features	3
Functions	4-6
Trim Designs	7
Options & Accessories	8-9
How to Order	10
Quick Codes	11-12
How to Specify	13

An economical, Grade 2 standard-duty lever lockset which provides an outstanding combination of value and performance. It's the ideal lever lockset for standard commercial applications. When used in conjunction with the CL3300 Series Extra Heavy-Duty Grade 1 and the CL3500 Series Heavy-Duty Grade 1 Cylindrical Lever Locksets, the overall cost of many projects may be reduced without compromising functionality and durability.



Typical applications include:

- Interior offices
- Closets
- Multi-family housing
- Restaurants
- Retail complexes

Advantages

- Lever Release™ for vandal resistance
- Solid cast levers
- ANSI/BHMA Grade 2 certification
- UL-cUL 3-hour fire rating
- Independent lever return springs
- Through-bolts on door for solid attachment
- Covers ANSI/BHMA door prep A156.115

Features

Handing

Non-handed.

Door Thickness Adjustment

Standard 1-3/8" to 1-3/4" (35 to 45mm); factory set for 1-3/4" doors. For 2" (51mm) and 2-1/4" (57mm) doors, specify door thickness. See Quick Codes, page 11-12.

Lock Chassis

Steel, zinc dichromated for corrosion resistance.

Backset

2-3/4" (70mm) standard. Optional: 2-3/8" (60mm), 3-3/4" (95mm) and 5" (127). See Quick Codes, page 11-12.

Latchbolt

1/2" (13mm) throw latch with universal "floating" front to fit both flat and beveled doors. 2-1/4" x 1-1/8" (57 x 29mm) square corner front for 2-3/4" (70mm) backset standard. For other latch options, See Quick Codes, page 11-12.

Auxiliary Latchbolt

Deadlocking latchbolt prevents manipulation when door is closed.

Strike

ANSI curved lip strike standard, 4-7/8" x 1-1/4" x 1-1/4" (124 x 32 x 32mm) lip to center. Optional strikes, lip lengths and ANSI wrought strike box available; See Quick Codes, page 11-12.

Cylinder

Brass, 6-pin, L4 keyway, "0" bitted standard.

Keying Features Available

Conventional 6-pin
Conventional 7-pin
Master keying
Construction master keying
Visual key control
Concealed key control
Pyramid® Security
Pyramid High Security
Interchangeable core (IC)
Security
Security IC
Pyramid Security IC
Pyramid High Security IC
Access 3®

Keys

Two nickel silver standard.

Warranty

Seven-year limited.

Certification/Compliance

ANSI/BHMA

Certified meets A156.2 Series 4000, Grade 2.
Meets A117.1 Accessibility Code.

Federal

Meets FF-H-106C.

California State Reference Code

(Formerly Title 19, California State Fire Marshal Standard)

All levers with returns comply; levers return to within 1/2" of door face.

UL-cUL

All locks listed for "A" label single doors.

Letter "F" and UL symbol on latch front indicate listing.

Any retrofit or other field modification to a fire rated opening can potentially impact the fire rating of the opening, and Corbin Russwin, Inc. makes no representations or warranties concerning what such impact may be in any specific situation. When retrofitting any portion of an existing fire-rated opening, or specifying and installing a new fire-rated opening, please consult with a code specialist or local code official (Authority Having Jurisdiction) to ensure compliance with all applicable codes and ratings.

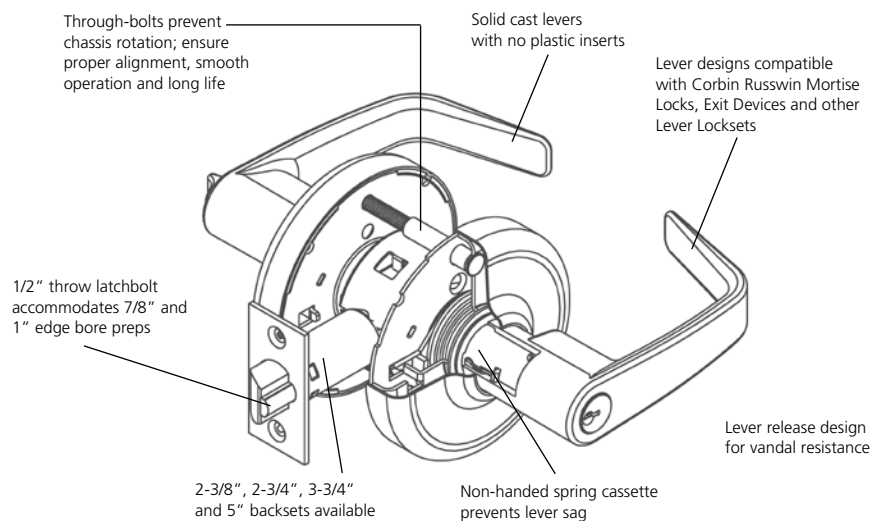

Functions

CL3800

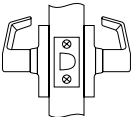
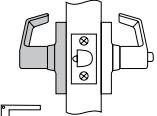
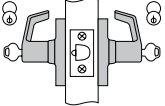
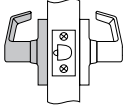
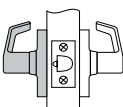
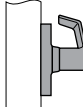
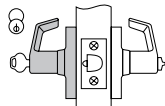
Outside	Inside	Series/Function	Type	ANSI No.	Function Description
		CL3810	Passage or Closet	F75	<ul style="list-style-type: none"> Latchbolt by lever either side Both levers always free.
		CL3820	Privacy Bedroom or Bathroom	F76A	<ul style="list-style-type: none"> Throw-off latchbolt by lever either side, except when push button locks outside lever. (Lever handle is free-wheeling in locked position.) Outside lever locked by push button. (Lever handle is free-wheeling in locked position.) Outside lever unlocked by emergency release tool, by rotating inside lever or by closing door. Inside lever always free.
		CL3832	Institutional or Utility	F87	<ul style="list-style-type: none"> Deadlocking latchbolt by key either side. (Lever handle is free-wheeling in locked position.)
		CL3840	Patio or Privacy	F77	<ul style="list-style-type: none"> Throw-off latchbolt by lever either side except when push button locks outside lever. (Lever handle is free-wheeling in locked position.) Outside lever locked by push button. Outside lever unlocked by rotating inside lever or by closing door. Inside lever always free. Should not be used in rooms that have no other entrance.
		CL3840NT	Exit Latch	F89	<ul style="list-style-type: none"> Deadlocking latchbolt by lever inside. Outside lever always locked. (Lever handle is free-wheeling.) Inside lever always free. Should not be used in rooms with no other entrance.
		CL3850	Half Dummy Trim	—	<ul style="list-style-type: none"> Lever acts as pull only; no operation. Lever is rigid.
		CL3851	Entrance or Office	F109	<ul style="list-style-type: none"> Deadlocking latchbolt by lever either side except when turn button locks outside lever. (Lever handle is free-wheeling in locked position). Pushing turn button locks outside lever, requiring use of key outside to unlock. Turning inside lever unlocks outside lever. Pushing in and turning button locks outside lever, requiring key at all times. Turning inside lever does not unlock outside lever until button is manually turned to unlocked position. Turning inside lever unlocks outside lever. Inside lever always free.

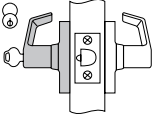
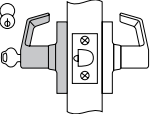
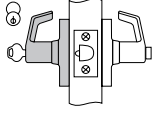
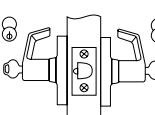
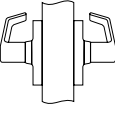
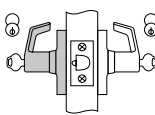
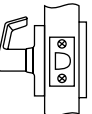
Outside	Inside	Series/Function	Type	ANSI No.	Function Description
		CL3855	Classroom	F84	<ul style="list-style-type: none"> • Deadlocking latchbolt by lever either side except when key outside locks outside lever. (Lever handle is free-wheeling in locked position.) • Outside lever unlocked by key outside. • Inside lever always free.
		CL3857	Storeroom or Closet	F86	<ul style="list-style-type: none"> • Deadlocking latchbolt by key in outside lever or by rotating inside lever. • Outside lever always locked (lever handle is free-wheeling in locked position). • Inside lever always free.
		CL3861	Entry or Office	F82	<ul style="list-style-type: none"> • Deadlocking latchbolt by lever either side, except when push button locks outside lever. • Push button released by turning inside lever or by key in outside lever. (Lever handle is free-wheeling in locked position.) • Closing door does not release push button. • Inside lever always free.
		CL3862	Communicating	F80	<ul style="list-style-type: none"> • Deadlocking latchbolt by lever either side except when key in either lever locks or unlocks the lever independently of the other. (Lever handle is free-wheeling in locked position.) • Should be used only in office or rooms with multiple entries. • Keyed alike unless otherwise specified.
		CL3870	Full Dummy Trim	—	<ul style="list-style-type: none"> • Levers act as pulls only; no operation. • Levers are rigid.
		CL3872	Apartment, Exit or Public Toilet	F88	<ul style="list-style-type: none"> • Deadlocking latchbolt by lever either side, except when key inside locks outside lever. (Lever handle is free-wheeling in locked position.) • Key outside retracts latchbolt. • Key inside unlocks outside lever. • Inside lever always free. • Keyed alike unless otherwise specified.
		CL3880	Passage Lever x Blank Plate	F111	<ul style="list-style-type: none"> • Deadlocking latchbolt by lever. • Lever on one side; blank plate on the other. • Lever always free. • For single or double communicating doors.

Functions

CL3800

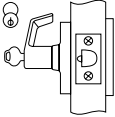
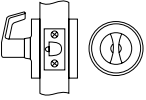
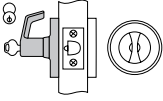
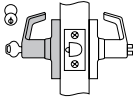
Outside	Inside	Series/Function	Type	ANSI No.	Function Description
		CL3881	Keyed Lever x Blank Plate	F113	<ul style="list-style-type: none"> • Deadlocking latchbolt by lever except when key locks lever (lever handle is free-wheeling in locked position). • Lever on one side; blank plate on other side. • Key unlocks lever.
		CL3890	Passage Lever x Turnpiece	—	<ul style="list-style-type: none"> • Latchbolt by lever or by turnpiece. • Lever on one side; turnpiece on other side. • Lever and turnpiece always free.
		CL3891	Keyed Lever x Turnpiece	—	<ul style="list-style-type: none"> • Deadlocking latchbolt by lever except when key locks lever. (Lever handle is free-wheeling in locked position.) • When lever is locked, latchbolt is operated by turnpiece. (Lever handle is free-wheeling in locked position.) • Lever on outside; turnpiece on inside. • Turnpiece always free. • Key unlocks lever.
		CL3893	Service Station	F92	<ul style="list-style-type: none"> • Throw-off latchbolt by lever, closing door, or by turning inside lever. • Outside lever locked by slotted push button. (Lever handle is free-wheeling in locked position.) • When slotted push button is pushed in and turned, outside lever becomes free-wheeling and deadlocking latch is activated. Key outside retracts latch. • Turning inside lever does not unlock outside lever until button is manually turned to unlocked position. • Inside lever always free.

Armstrong



AZD

Lever: Die-cast zinc
Rose: Wrought brass or bronze

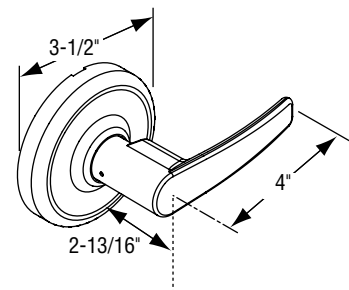

Newport

Complies with codes requiring lever to return to within 1/2" (13mm) of door face.



NZD

Lever: Die-cast zinc
Rose: Wrought brass or bronze

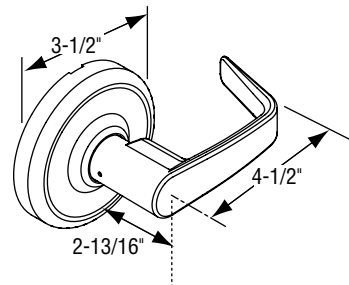

Princeton

Complies with codes requiring lever to return to within 1/2" (13mm) of door face.

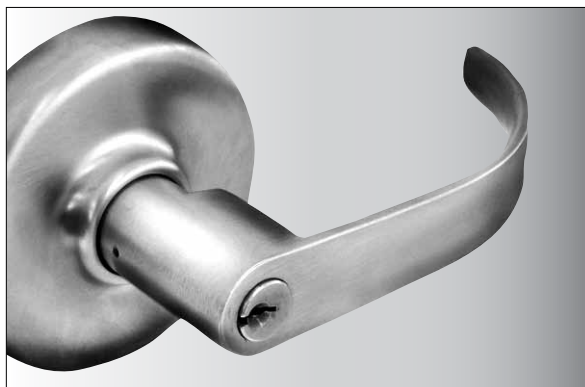

PZD

Lever: Die-cast zinc
Rose: Wrought brass or bronze

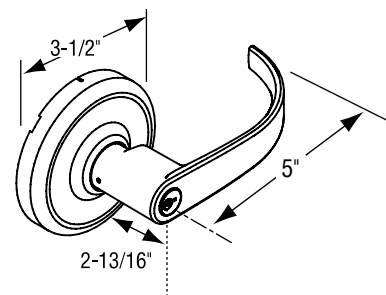

Options & Accessories

CL3800

Latches

To order optional latchbolt with lockset, see How to Order, page 10.
To order latchbolt separately, specify Part No. x Finish (e.g., 599F91 x 626).

Backset and Front Description		Plain	Deadlocking	Throw-Off
2-3/8" Backset	1" width, square corner	599F91	599F92	599F93
	1" width, rounded corner	599F94	599F95	599F96
	1-1/8" width, square corner	599F97	599F98	599F99
	1-1/8" width, rounded corner	600F00	600F01	600F02
2-3/4" Backset	1" width, square corner	600F03	600F04	600F05
	1" width, rounded corner	600F06	600F07	600F08
	1-1/8" width, square corner	600F09	600F10	600F11
	1-1/8" width, rounded corner	600F12	600F13	600F14
3-3/4" Backset	1-1/8" width, square corner	600F62	600F63	600F64
	1-1/8" width, rounded corner	600F65	600F66	600F67
5" Backset	1-1/8" width, square corner	600F68	600F69	600F70
	1-1/8" width, rounded corner	600F71	600F72	600F73

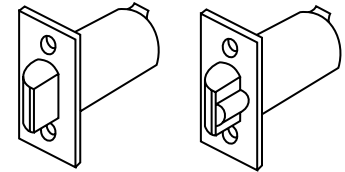

Plain (CL3810) Deadlocking (All other functions)

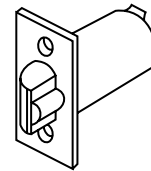

Throw-Off (CL3820, CL3893 & CL3840)

Housing diameter 7/8" for all models. 1" diameter latch sleeve furnished with each latchbolt.

Cylinders

		Standard Cylinder	Interchangeable Core
		.509" plug diameter conventional .552" plug diameter security .496" plug diameter Pyramid Brass, 6-pin 2 nickel silver keys Finishes: 606, 626	.509" plug diameter conventional .552" plug diameter security .496" plug diameter Pyramid Brass, 6-pin 2 nickel silver keys Finishes: 605, 606, 611, 612, 613, 613E, 625, 626, 722
Conventional	6-pin	2000-033 (standard)	8000
	7-pin	2000-033-7	8000-7
Security	6-pin	2010-033	8010
Pyramid High Security	7-pin	2020-033	8020
Pyramid Security	7-pin	2027-033	8027
Access 3® AP	6-pin	2500-033	8500
Access 3® AS	6-pin	2600-033	8600
Access 3® AHS	6-pin	2700-033	8700
Schlage® C Keyway	6-pin	2400-033-C	—
Sargent® LA Keyway	6-pin	2400-033-LA	—

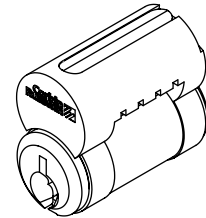
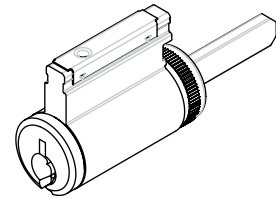

To order optional cylinder with lockset, see How to Order, page 10.
To order cylinder separately, specify Part No. x Keyway x Finish (e.g., 8000 x L4 x 626).

Compatibility with Competitive Cylinders

Competitive Cylinder	Parts Required for Installation
Schlage conventional 21-002, 23-001 or 23-013	682F398 tailpiece included with M06 option.
Schlage Primus 20-548, 20-550, 20-748 or 20-750	682F398 tailpiece included with M06 option.
Schlage 6-pin Interchangeable Core	Specify M69 - 697F942 Tailpiece included with M69 option.
SFIC style core, 6 or 7-pin	682F95-8 tailpiece kit and special lever (NZD and PZD designs only) included with M08 option. Accommodates 6 and 7-pin cores.
Sargent 13-3266	599F38-9 Tailpiece kit and special lever. Included with M09 options. See How to Order, page 10.

For Assa® and Medeco® retrofit cylinders, consult those manufacturers' catalogs.

Strikes

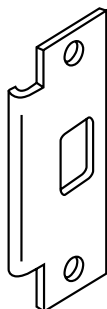

ANSI Curved Lip (standard)

Brass or stainless steel.
4-7/8" x 1-1/4" x 1-1/4" lip to center.
Optional lip lengths: 1", 1-1/8",
1-3/8", 1-1/2", 1-3/4", 2", 2-1/4", 2-1/2",
2-3/4", 3".
To order separately, specify 217L13 x Lip
Length x Finish.

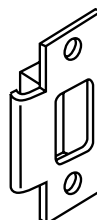

Curved Lip "T" Strike

Brass.
2-3/4" x 1-1/8" x 1-1/4" lip to center.
Optional lip lengths: 1", 1-1/8",
1-3/8", 1-1/2", 1-3/4", 2", 2-1/4", 2-1/2",
2-3/4", 3".
To order with lockset, specify quick code
found on pages 11.
To order separately, specify 586L19 x Lip
Length x Finish.

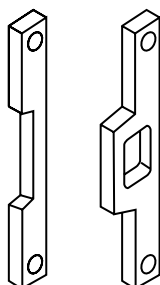

Rabbeted Front and Strike

Brass or bronze.
4" x 5/8" for 1/2" rabbet.
No optional lip lengths.
To order with lockset, specify quick code
found on pages 11.
To order separately, specify 601F28 x Finish.



ANSI Wrought Strike Box

To order with lockset, specify quick code
found on page 12. To order separately,
specify 120F768.

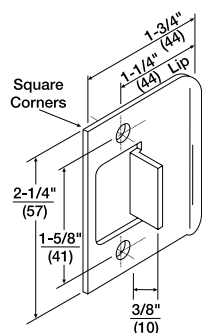

Full Lip Strike

Brass or stainless steel.
2-1/4" x 1-3/4" x 1-1/4" lip to center.
No optional lip lengths.
To order with lockset, specify quick code
found on pages 11.
To order separately specify 680L50M020 x
Finish.
Anti-rattle tab.

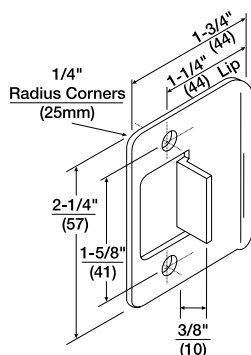

Full Lip Strike – 1/4" Radius Corners

Brass or stainless steel.
Similar in dimension and function to L50
strike (above) but with radius corners for
easy mortising by power tools.
To order with lockset, specify quick code
found on pages 11.
To order separately specify 680L51M020 x
Finish.
Anti-rattle tab.

How to Order

CL3800

Ordering Examples

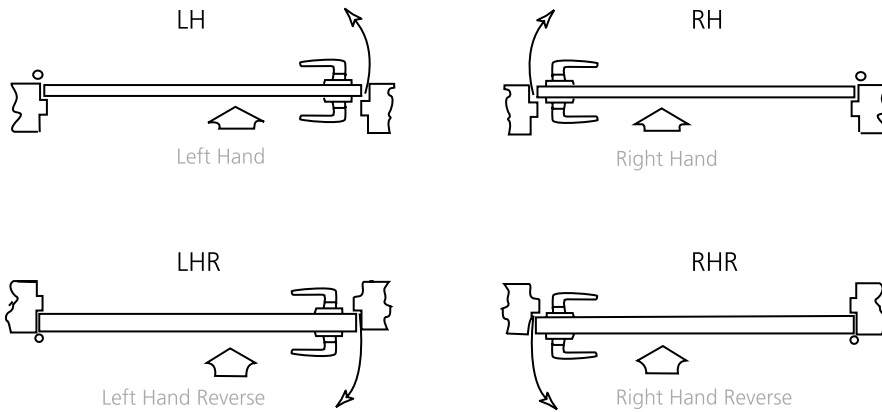

Where to find ordering information and quick codes

Series/Function	Pages 4-6
Trim Designs	Page 7
Finish	Page 11
Door Thickness	Page 11
Backset	Page 11
Strike	Page 11
Cylinders and Keying	Page 11
Miscellaneous Options	Page 12

Stock Order

Quantity	Series/Function	Trim	Finish	Hand
100	CL3855	NZD	626	RHR

Split Trim / Finish Order

Quantity	Series/Function	Trim		Finish		Hand
		Outside	Inside	Outside	Inside	
12	CL3855	NZD	AZD	626	625	RH



Contract / Detailed Order

Quantity	Keyset	Series/Function	Trim	Finish	Hand	Door Thickness	Backset	Optional Strike	Misc. Options	Optional Cylinder	Keying
24	AA1	CL3855	NZD	626	RHR	D214	B238	SC114	M17	PHS	CKC2

Cylinder and Keying

Description	Specify
Conventional 6-pin	(standard)
Conventional 7-pin	7P
Less cylinder(s)	LC
IC 6-pin	C6
IC 6-pin with Temporary Construction Core (Red)	CT6R
IC 6-pin with Temporary Construction Core (Blue)	CT6B
IC 6-pin with Temporary Construction Core (Green)	CT6G
IC 6-pin with temporary construction core	CT6
IC 6-pin less core	CL6
SFIC 6- or 7-pin Small Format Disposable Core	CTSD
IC 7-pin	C7
IC 7-pin less core	CL7
IC 7-pin with temporary construction core	CT7
IC 7-pin with Temporary Construction Core (Red)	CT7R
IC 7-pin with Temporary Construction Core (Blue)	CT7B
IC 7-pin with Temporary Construction Core (Green)	CT7G
Security	HS
Security IC	CHS
Access 3® AP Fixed Core	AP
Access 3® AS Fixed Core	AS
Access 3® AHS Fixed Core	AHS
Access 3® AP IC	ACP
Access 3® AS IC	ACS
Access 3® AHS IC	ACHS
Pyramid High Security Fixed Core	PHS
Pyramid High Security IC	PCHS
Pyramid IC Less Core	CLP
Pyramid with temporary construction core	CTP
Pyramid Security Fixed Core	PS
Pyramid Security IC	PCS
Pyramid Disposable Core	CTPD
6-Pin Disposable Core	CT6D
7-Pin Disposable Core	CT7D
0-bitted with 2 blank keys	(standard)
Keyed random	KR
Construction master keyed	CMK
Visual key control (VKC)	
No bitting or keyset stamping on keys	VKC0
Keys only	VKC1
Cylinders and keys (not for HS, CHS, PHS, PCHS or Access 3®)	VKC2
Cylinders only (not for HS, CHS, PHS, PCHS or Access 3®)	VKC3
Concealed key control (CKC)	
CKC cylinders with VKC keys	CKC2
CKC cylinders only (not for PHS, PCHS, Access 3®)	CKC3
2 keys per lock	(standard)
More than 2 keys	KY# (e.g., KY6)
Schlage® C keyway cylinder	C
Sargent® LA keyway cylinder	LA

Finishes

Description	Specify
ANSI/BHMA 605 (US3)	Bright Brass 605
ANSI/BHMA 606 (US4)	Satin Brass 606
ANSI/BHMA 611 (US9)	Bright Bronze 611
ANSI/BHMA 612 (US10)	Satin Bronze 612
ANSI/BHMA 613 (US10B)	Dark Oxidized Satin Bronze, Oil Rubbed 613
613E	Dark Oxidized Satin Bronze, Equivalent 613E
613L	Dark Oxidized Satin Bronze, Clear Coated 613L
ANSI/BHMA 618 (US14)	Bright Nickel Plated 618
ANSI/BHMA 619 (US15)	Satin Nickel Plated 619
619C	Satin Nickel Plated with Microshield®  619C
ANSI/BHMA 625 (US26)	Bright Chromium Plated 625
ANSI/BHMA 626 (US26D)	Satin Chromium Plated 626
626C	Satin Chromium Plated with MicroShield®  626C
ANSI/BHMA 722	Black Oxidized Bronze, oil rubbed 722

Strikes

ANSI Lip to Center	ANSI Curved Lip Specify	Curved Lip Box Specify	Full Lip Specify	Full Lip Radius Corner Specify
1" (25mm)	SA100	SC100	N/A	N/A
1-1/8" (29mm)	SA118	SC118	N/A	N/A
1-1/4" (32mm)	(standard)	SC114	SF114	SFR114
1-3/8" (35mm)	SA138	SC138	N/A	N/A
1-1/2" (38mm)	SA112	SC112	N/A	N/A
1-3/4" (44mm)	SA134	SC134	N/A	N/A
2" (51mm)	SA200	SC200	N/A	N/A
2-1/4" (57mm)	SA214	SC214	N/A	N/A
2-1/2" (64mm)	SA212	SC212	N/A	N/A
2-3/4" (70mm)	SA234	SC234	N/A	N/A
3" (76mm)	SA300	SC300	N/A	N/A

Rabbeted front and strike

Specify SR118

Door Thickness

Door Thickness	Specify
1-3/8" (35mm) - 1-3/4" (44mm)	(standard)
2" (51mm) - 2-1/4" (57mm)	D214

Backset

Description	Specify
2-3/8" (60mm)	B238
2-3/4" (70mm)	(standard)
3-3/4" (95mm)	B334
5" (127mm)	B500

Quick Codes

CL3800

Miscellaneous Options

Description	Specify
Spanner head screws	M02
Less cylinder, with tailpiece for Schlage® cylinder	M06
Lever to accept SFIC 6 or 7-pin interchangeable core (NZD & PZD design only)	M08
Lever to accept Sargent® cylinder (NZD & PZD designs only)	M09
Lever to accept Schlage® Interchangeable core (NZD & PZD design only)	M69
Rounded corners on latch front	M13
1" latch front, square corners (standard for 2-3/8" backset)	M14
1" latch front, rounded corners	M15
ANSI wrought strike box	M17
Knurling outside and inside	M20
Knurling outside only	M21
Knurling inside only	M22
Abrasive coat outside and inside	M23
Abrasive coat inside only	M24
Abrasive coat outside only	M25
1-1/8" front, square corners (standard for 2-3/4", 3-3/4" and 5" backsets)	M32

Suggested Specification

Lockset chassis shall be constructed of heavy gauge steel and cast components, plated to protect against rust and corrosion. Locksets shall be adjustable for 1-3/8" (35mm) and 1-3/4" (44mm) or 2" (51mm) and 2-1/4" (57mm) door thickness.

Locksets shall be non-handed, and shall install easily without the need for specialized installation tools. Locksets shall have separate anti-rotation through-bolts in the 6 o'clock and 12 o'clock position outside the 2-1/8" face bore, and shall have no exposed mounting screws.

Locksets shall have solid one-piece, cast levers without plastic inserts, and shall be a minimum of 4" (102mm) in length. Levers shall operate independently, and shall have inside and outside lever return springs. Outside levers on the keyed locksets shall be removable only when the designated key is in the cylinder.

Vandal-resistant levers shall be offered as a standard feature in all locking functions and shall be free-wheeling in the locked condition. Locksets that are rigid in the locked condition, or must require resetting (breakaway) are not acceptable.

All locksets shall carry a seven-year mechanical warranty.

All locksets shall comply with the following certifications:

- UL-cUL 3-Hour Fire Rating
- ANSI/BHMA A156.2 Series 4000, Grade 2
- ANSI/BHMA A117.1 Accessibility Code
- ANSI/BHMA A115.1B Preparation

All locksets shall be CL3800 Series Grade 2 Key-in-Lever Cylindrical Locksets as manufactured by Corbin Russwin Architectural Hardware.

ASSA ABLOY is the global leader in door opening solutions, dedicated to satisfying end-user needs for security, safety and convenience



ASSA ABLOY

In U.S.

Corbin Russwin
Architectural Hardware
225 Episcopal Road
Berlin, CT 06037
Phone: 800-543-3658
Fax: 800-447-6714
corbinrusswin.com

In Canada

ASSA ABLOY Door
Security Solutions Canada
160 Four Valley Drive
Vaughan, Ontario
Canada L4K 4T9
Phone: 800-461-3007
Fax: 905-738-2478
www.assaabloy.ca

For more information regarding Corbin Russwin Locksets, Exit Devices, Door Controls and Key Systems, contact your authorized Corbin Russwin Distributor or Sales Representative.



MicroShield®

As part of their promise to provide innovative solutions to their customers, certain ASSA ABLOY Group brands offer the MicroShield® technology, a silver-based antimicrobial coating designed to inhibit the growth of bacteria.

MicroShield® is a registered trademark of Yale Security Inc., an ASSA ABLOY Group company.

Corbin Russwin and Design® and Access 3® are registered trademarks of Corbin Russwin, Inc., an ASSA ABLOY Group company. Lever Release™ is a trademark of Corbin Russwin, Inc., an ASSA ABLOY Group company. Other products' brand names may be trademarks or registered trademarks of their respective owners and are mentioned for reference purposes only. These materials are protected under US copyright laws. All contents current at time of publication. Corbin Russwin, Inc., an ASSA ABLOY Group Company, reserves the right to change availability of any item in this catalog, its design, construction, and/or its materials. Copyright © 2007, 2015 Corbin Russwin, Inc., an ASSA ABLOY Group company. All rights reserved. Reproduction in whole or in part without the express written permission of Corbin Russwin, Inc. is prohibited.