

**Corbin
Russwin** 

ASSA ABLOY

Padlocks & Deadlocks

PL5000, DL2200/DL3200, DL3000 &
DL4100 Series



ASSA ABLOY, the global leader
in door opening solutions

Padlocks PL5000 Series

Padlocks & Deadlocks

Rekeyable Fixed Core (RFC) and Interchangeable Core (IC) Models

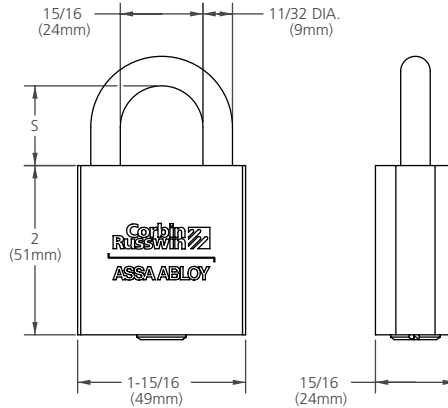

Model	Series	Shackle Clearance S
RFC	PL5000R	Std: 7/8" (22mm) 258: 2-5/8" (67mm)
	PL5100R	
	PL5200R	
IC	PL5070	
	PL5170	
	PL5270	

Features

Case

Extruded brass.

Shackle

11/32" (9mm) diameter hardened steel (PL5000 Series), brass (PL5100 Series) or stainless steel (PL5200 Series).

Locking

Ball-bearing locking heel and toe.

Cylinder

RFC model: 6-pin Fixed Core (2300)
IC model: 6-Pin, Security, Pyramid & Access 3 (8000 Series)
L4 keyway standard

Keying Features Available

Master keying
Construction master keying
Interchangeable core (IC) 6-pin
IC security
Concealed key control
Visual key control (not for HS)
Pyramid (IC only)
Access 3® (IC only)

Keys

Two nickel silver standard.

Warranty

One-year limited.

Finish

BHMA 606 Satin Brass (US4) only.

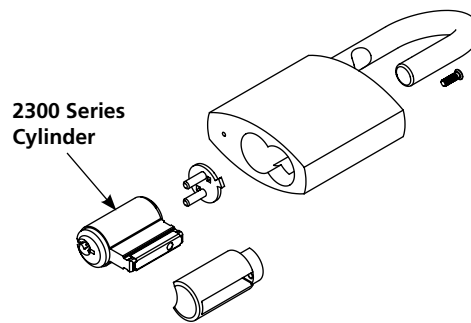

RFC MODEL

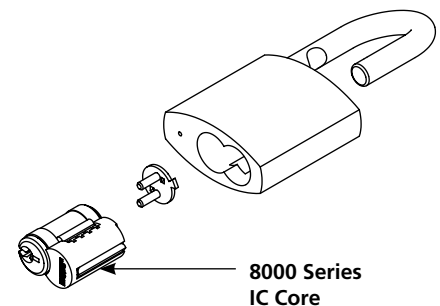

IC MODEL

Padlocks PL5000 Series

Padlocks & Deadlocks

Ordering Examples

Stock Order

Quantity	Series/Function
10	PL5000R

Contract/Detailed Order

Quantity	Keyset	Series/Function	Shackle Length	Misc. Options
4	AJ3	PL5080	258	M45 x S19866

Quick Codes

Series/Function

Description	Series/Function		
	Hardened Steel Shackle	Brass Shackle	Stainless Steel Shackle
Rekeyable Fixed Core (RFC)	PL5000R	PL5100R	PL5200R
Interchangeable core (IC) less core	PL5070	PL5170	PL5270
IC 6-pin	PL5080	PL5180	PL5280
IC security	PL5090	PL5190	PL5290
Pyramid High Security (IC)	PL5030	PL5130	PL5230
Pyramid Security (IC)	PL5037	PL5137	PL5237

Miscellaneous Options

Description	Specify
Chain and clevis attached	M44
Custom die stamped case (specify existing die number, or provide lettering specifications or artwork)	M45 x #

Cylinder Only

Description	Specify
Removable Core	
Standard 6-pin	2300
Interchangeable Core	
Standard 6-pin	8000
Security	8010
Pyramid High Security	8020
Pyramid Security	8027
Access 3® - Patented	8500
Access 3® - Security	8600
Access 3® - High Security	8700

Cylinder and Keying

Description	Specify
Keyed random (standard for Pyramid & IC security padlocks)	KR
0-bitted (not available for Pyramid & IC security padlocks)	(standard)
Construction Master Keyed (RFC & IC 6-pin padlocks only)	CMK
Temporary construction core (Red) (IC 6-pin padlocks only)	CT6R
Temporary Construction Core (Blue) (IC 6-pin padlocks only)	CT6B
Temporary Construction Core (Green) (IC 6-pin padlocks only)	CT6G
Visual key control (VKC)	
- Keys only	VKC1
- Locks and keys (RFC & IC 6-pin padlocks only)	VKC2
- Locks only (RFC & IC 6-pin padlocks only)	VKC3
Concealed key control (CKC) (IC 6-pin & IC security padlocks only)	
- CKC cores and VKC keys	CKC2
- CKC cores only	CKC3
2 keys per lock	(standard)
More than 2 keys	KY# (e.g., KY6)
Rekeyable FC (RFC) Less Cylinder	LC
Access 3® Patented IC	ACP
Access 3® Security IC	ACS
Access 3® High Security IC	ACHS

Shackle Clearance

Description	Specify
7/8" (22mm)	(standard)
2-5/8" (67mm)	258

Deadlocks DL2200/DL3200 Series

Padlocks & Deadlocks

Features

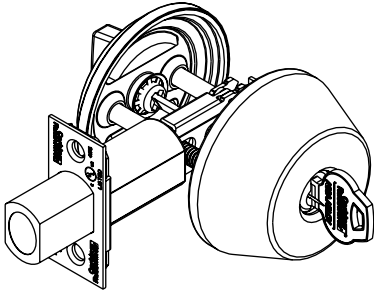

Handing Non-handed.

Door Thickness Standard: 1-3/4" (44mm). Optional door thicknesses available; see Quick Codes.

Backset Standard: 2-3/4" (70mm)
Optional: 2-3/8" (60mm)

Front Standard: brass or stainless steel, 2-1/4" (57mm) x 1-1/8" (29mm).
Optional: 1" width; see Quick Codes.

Deadbolt 1" throw, solid steel deadbolt with hardened, free spinning, steel pin insert.

Strike Standard; 2-3/4" (70mm) x 1-1/8" (29mm). Optional strikes and wrought boxes available; see Strikes, this page.

Cylinder Standard: brass, 6-pin, L4 keyway, 0-bitted. Security cylinder optional; see Quick Codes.

Keys Two nickel silver standard.

Keying Features Available

Master keying
Construction master keying
Security
Visual key control
Concealed key control

Warranty One-year limited.

Certification/Compliance

UL

UL10B/UL10C Fire Rated Auxiliary Lock for A label and lesser class doors when used with a correspondingly rated primary latching device.

ANSI

DL2200 - 156.5 Grade 2
DL3200 - 156.5 Grade 1

Any retrofit or other field modification to a fire rated opening can potentially impact the fire rating of the opening, and Corbin Russwin, Inc. makes no representations or warranties concerning what such impact may be in any specific situation. When retrofitting any portion of an existing fire-rated opening, or specifying and installing a new fire-rated opening, please consult with a code specialist or local code official (Authority Having Jurisdiction) to ensure compliance with all applicable codes and ratings.

Functions

Outside	Inside	Series/ Function	Type	ANSI No.	Function Description
		DL2213 DL3213	Single Cylinder	E0150 Series	- By key outside and by thumbturn inside.
		DL2212 DL3212	Double Cylinder	E0140 Series	- By key either side.
		DL2217 DL3217	Classroom	E0170 Series	- By key outside and by thumbturn inside. - Thumbturn will retract but not project deadbolt.
		DL2211 DL3211	Cylinder x Blank	E0160 Series	- By key one side only; opposite side blank.
		DL2260 DL3260	Thumbturn x Blank	E0190 Series	- By thumbturn one side only; opposite side blank.

Strikes



Metal Frame Strike

Standard
2-3/4" (70mm) x 1-1/8" (29mm).
To order separately, specify
781F568 x Finish

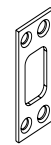

Wood Frame Strike

Standard
2-3/4" (70mm) x 1-1/8" (29mm).
To order separately, specify
781F558 x Finish.



Strike Box

Standard with standard strikes.
To order separately, specify
781F599.

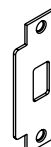

ANSI Strike

Optional; see Quick Codes.
To order separately, specify
423L71 x Finish.

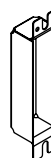

ANSI Wrought Strike Box

Optional for use with ANSI
strike; see Quick Codes. To order
separately, specify 120F768.

Deadlocks DL2200/DL3200 Series

Padlocks & Deadlocks

Ordering Examples

Stock Order

Quantity	Series/Function	Finish
24	DL2213	626

Contract/Detailed Order

Quantity	Keypad	Series/Function	Finish	Strike	Options
24	AA1	DL2213	626	SS078	HS-CKC2

Cylinders

Cylinder Only (less housing)

Function	Part Number	Cylinder Type	Door Thickness
11,13,17	4400-134-A51	6-Pin Conventional	1-3/8" (35mm) 1-3/4" (44mm) 2" (51mm) 2-1/4" (57mm)
	4400-134-A51-7	7-Pin Conventional	
	4410-134-A51	Security	
	4420-134-A51	Pyramid High Security	
	4427-134-A51	Pyramid Security	
	4500-134-A51	Access 3® Patented	
	4600-134-A51	Access 3® Security	
	4700-134-A51	Access 3® High Security	
12	4400-134-A52	6-Pin Conventional	1-3/8" (35mm) 1-3/4" (44mm) 2" (51mm) 2-1/4" (57mm)
	4400-134-A52-7	7-Pin Conventional	
	4410-134-A52	Security	
	4420-134-A52	Pyramid High Security	
	4427-134-A52	Pyramid Security	
	4500-134-A52	Access 3® Patented (AP)	
	4600-134-A52	Access 3® Security (AS)	
	4700-134-A52	Access 3® High Security (AHS)	
	4400-214-A52	6-Pin Conventional	
	4400-214-A52-7	7-Pin Conventional	
	4410-214-A52	Security	
	4420-214-A52	Pyramid High Security	
	4427-214-A52	Pyramid Security	
	4500-214-A52	Access 3® Patented (AP)	
4600-214-A52	Access 3® Security (AS)		
4700-214-A52	Access 3 High Security (AHS)		
11,12,13,17	8000	6-Pin IC	See the Housing Assembly for Interchangeable Core Cylinder chart below.
	8000-7	7-Pin IC	
	8010	Security IC	
	8020	Pyramid High Security IC	
	8027	Pyramid Security IC	
	8500	Access 3® Patented IC	
	8600	Access 3® Security IC	
	8500	Access 3® High Security IC	

Housing Assembly - Interchangeable Core Cylinder

Function	Part Number	Accept Cylinder	Door Thickness
11,13,17	4440-134-A51	6 & 7 Pin SFIC	1-3/8" (35mm) 1-3/4" (44mm) 2" (51mm) 2-1/4" (57mm)
	4470-134-A51	6-Pin LFIC	
	4470-134-A51-7	7-Pin LFIC	
12	4440-138-A52-XX (*)	6 & 7 Pin SFIC	1-3/8" (35mm)
	4470-138-A52-XX	6-Pin LFIC	
	4470-138-A52-7-XX	7-Pin LFIC	
	4440-134-A52-XX	6 & 7 Pin SFIC	1-3/4" (44mm)
	4470-134-A52-XX	6-Pin LFIC	
	4470-134-A52-7-XX	7-Pin LFIC	
	4440-200-A52-XX	6 & 7 Pin SFIC	2" (51mm)
	4470-200-A52-XX	6-Pin LFIC	
	4470-200-A52-7-XX	7-Pin LFIC	
	4440-214-A52-XX	6 & 7 Pin SFIC	2-1/4" (57mm)
	4470-214-A52-XX	6-Pin LFIC	
4470-214-A52-7-XX	7-Pin LFIC		

(*) Specify "OS" for outside of door or "IS" for inside of door.

Cylinder and Keying

Description	Specify
Conventional 6-pin	(standard)
Less cylinder(s)	LC
Conventional 7-pin	7P
Interchangeable core (IC) 6-pin	C6
IC 6-pin less core	CL6
SFIC 6-pin with Less Core	CLS6
IC 6-pin with temporary construction core	CT6
IC 7-pin	C7
IC 7-pin less core	CL7
SFIC 7-pin with Less Core	CLS7
IC 7-pin with temporary construction core	CT7
Security	HS
Security IC	CHS
Pyramid High Security Fixed Core	PHS
Pyramid High Security IC	PCHS
Pyramid Security Fixed Core	PS
Pyramid Security IC	PCS
Access 3® Patented Fixed Core	AP
Access 3® Security Fixed Core	AS
Access 3® High Security Fixed Core	AHS
Access 3® Patented IC	ACP
Access 3® Security IC	ACS
Access 3® High Security IC	ACHS
0-bitted with 2 blank keys	(standard)
Keyed random	KR
Construction Master Keyed (not available for Pyramid & Security cylinders)	CMK
Visual key control (VKC)	
- Keys only	VKC1
- Cylinders and keys (not available with HS or CHS)	VKC2
- Cylinders only (not available with HS or CHS)	VKC3
Concealed key control (CKC)	
- CKC cylinders and VKC keys	CKC2
- CKC cylinders only	CKC3
2 keys per lock	(standard)
More than 2 keys (e.g., KY6)	KY#

Deadlocks DL2200/DL3200 Series

Padlocks & Deadlocks

Quick Codes

Finish

	Description	Specify
US3	Bright Brass	605
US4	Satin Brass	606
US10	Satin Bronze	612
US10B	Dark Oxidized Satin Bronze, oil rubbed	613
US10BE	Dark Oxidized Satin Bronze - equivalent	613E
US26	Bright Chromium Plated	625
US26D	Satin Chromium Plated	626

Door Thickness

Description	Specify
1-3/8" (35mm)	D138
1-3/4" (44mm)	(standard)
2" (51mm)	D200
2-1/4" (57mm)	D214

Strike

Lip to Center	ANSI Straight Lip Specify
7/8" (22mm)	SS078
1-1/8" (29mm)	SS118
1-1/4" (32mm)	SS114
1-3/8" (35mm)	SS138
1-1/2" (38mm)	SS112
1-3/4" (44mm)	SS134
2" (51mm)	SS200
2-1/4" (57mm)	SS214
2-1/2" (64mm)	SS212
2-3/4" (70mm)	SS234
3" (76mm)	SS300

Miscellaneous Options

Description	Specify
ANSI wrought strike box	M17
Plastic box for standard strike	(standard)

Bolt Assembly

Description	Part No.	Specify
2-3/8" (60mm) Backset	781F528	B238
2-3/4" (70mm) Backset	781F538	(standard)

Front Trim Plates

Description	Part No.	Specify
1" (25mm) Wide	781F50M x Finish	M14
1-1/8" (29mm) Wide	781F51M x Finish	(standard)

Deadlocks DL3000 Series

Padlocks & Deadlocks

Features

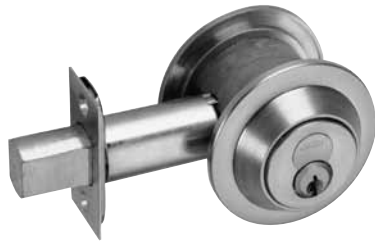

Handing

Non-handed, except DL3017, which is handed and field reversible.

Door Thickness

Standard: 1-3/4" (44mm) - 2-1/4" (57mm).
Optional door thicknesses available; see Quick Codes.

Backset

Standard: 2-3/4" (70mm)
Optional: 2-3/8" (60mm)

Front

Standard: wrought brass or bronze,
2-1/4" (57mm) x 1-1/8" (29mm).
Accommodates flat doors and doors
beveled 1/8" (3mm) in 2" (51mm).

Deadbolt

Zinc diecast hardened steel insert. 1"
(25mm) throw, 5/8" (16mm) wide x 3/4"
(19mm) high.

Strike

Standard; 2-3/4" (70mm) x 1-1/8"
(29mm).
Optional strikes and wrought boxes
available; see Strikes, this page.

Cylinder

Brass, 6-pin, L4 keyway, 0-bitted. Security
cylinders optional; see Quick Codes.

Keys

Two nickel silver standard.

Keying Features Available

Master keying
Construction master keying
7-pin (FC) conventional
Interchangeable core (IC)
Security
Security (IC)
Visual key control
Concealed key control
Pyramid (FC)
Pyramid (IC)

Warranty

One-year limited.

Functions

Outside	Inside	Series/ Function	Type	ANSI No.	Function Description
		DL3013	Single Cylinder	E0150 Series	- By key outside and by thumbturn inside.
		DL3012	Double Cylinder	E0140 Series	- By key either side.
		DL3017	Classroom	E0170 Series	- By key outside and by thumbturn inside. - Thumbturn will retract but not project deadbolt.
		DL3011	Cylinder x Blank	E0160 Series	- By key one side only; opposite side blank.
		DL3060	Thumbturn x Blank	E0190 Series	- By thumbturn one side; opposite side blank.

Strikes



Standard Strike

2-3/4" (70mm) x
1-1/8" (29mm).
To order separately,
specify 424F83 x
Finish.

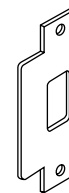

ANSI Strike

Optional; see Quick
Codes.
To order separately,
specify 423L71 x
Finish.

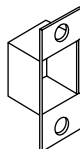

Wrought Strike Box

Standard with
Standard Strike.
To order separately,
specify 496F71-8.

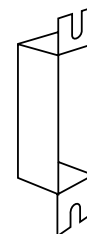

ANSI Wrought Strike Box

Optional for use
with ANSI Strike; see
Quick Codes.
To order separately,
specify 120F76-8.



Optional Strike

3-1/2" (89mm) x
1-1/8" (29mm); see
Quick Codes.
To order separately,
specify 394F19 x
Finish.

Deadlocks DL3000 Series

Padlocks & Deadlocks

Ordering Examples

Stock Order

Quantity	Series/Function	Finish
24	DL3013	626

Contract/Detailed Order

Quantity	Keyset	Series/Function	Finish	Optional Strike	Door Thickness	Misc. Options
24	AA1	DL3013	613	SS118	D214	C6-M17

Quick Codes

Finish

	Description	Specify
US3	Bright Brass	605
US4	Satin Brass	606
US10	Satin Bronze	612
US10B	Dark Oxidized Satin Bronze, oil rubbed	613
US10BE	Dark Oxidized Satin Bronze - equivalent	613E
US26	Bright Chromium Plated	625
US26D	Satin Chromium Plated	626

Strike

Lip to Center	ANSI Straight Lip Specify
7/8" (22mm)	SS078
1-1/8" (29mm)	SS118
1-1/4" (32mm)	SS114
1-3/8" (35mm)	SS138
1-1/2" (38mm)	SS112
1-3/4" (44mm)	SS134
2" (51mm)	SS200
2-1/4" (57mm)	SS214
2-1/2" (64mm)	SS212
2-3/4" (70mm)	SS234
3" (76mm)	SS300
Other Strikes (no lip)	Specify
2-3/4" (70mm) x 1-1/8" (29mm)	(standard)
3-1/2" (89mm) x 1-1/8" (29mm)	SD001

Door Thickness

Description	Specify
1-3/4" (44mm) - 2" (51mm)	(standard)
2-1/4" (57mm)	D214
1-3/8" (35mm)	D138

Miscellaneous Options

Description	Specify
ANSI wrought strike box	M17
Wrought box for standard strike	(standard)

Cylinder and Keying

Description	Specify
Conventional 6-pin	(standard)
Less cylinder(s)	LC
Conventional 7-pin	7P
SFIC 7-pin with Less Core	CLS7
Interchangeable core (IC) 6-pin	C6
IC 6-pin less core	CL6
SFIC 6-pin with Less Core	CLS6
IC 6-pin with temporary construction core	CT6
Security	HS
Security IC	CHS
Pyramid High Security Fixed Core	PHS
Pyramid High Security IC	PCHS
Pyramid Security Fixed Core	PS
Pyramid Security IC	PCS
Pyramid Temp Core	CTP
Access 3 [®] Patented Fixed Core	AP
Access 3 [®] Security Fixed Core	AS
Access 3 [®] High Security Fixed Core	AHS
Access 3 [®] Patented IC	ACP
Access 3 [®] Security IC	ACS
Access 3 [®] High Security IC	ACHS
0-bitted with 2 blank keys	(standard)
Keyed random	KR
Construction master keyed	CMK
Visual key control (VKC)	
- Keys only	VKC1
- Cylinders and keys (not available with HS or CHS)	VKC2
- Cylinders only (not available with HS or CHS)	VKC3
Concealed key control (CKC)	
- CKC cylinders and VKC keys	CKC2
- CKC cylinders only	CKC3
UL IC 6-Pin Housing Less Core	CL6AH
UL IC 6-Pin Housing with Disposable Core	CTAHD
UL IC 6-Pin Housing with (Red/Blue/Green) Temporary Construction Core	CT6AH(R/B/G)
2 keys per lock	(standard)
More than 2 keys (e.g., KY6)	KY#

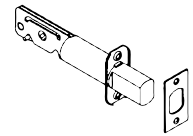

Bolt and Front

Description	Part No.	Specify
2-3/4" (70mm) backset bolt (less front)	467F35-8	(standard)
2-3/8" (60mm) backset bolt (less front)	693F20-8	B238
1-1/8" (29mm) front	467F36	—

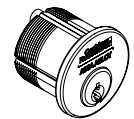

Cylinder Only

Specify Part No. x Keyway x Finish

Description	Number
Conventional 6-pin	1000-118-A03
Conventional 7-pin	1000-114-A03-7
IC 6-pin	1080-114-A03
IC 6-pin less core	1070-114-A03
Security	1010-118-A03
Security IC	1090-114-A03
Pyramid (FC) Conventional	1020-114-A03
Pyramid (IC)	1030-114-A03
Access 3 Patented Fixed Core	1500-114-A03
Access 3 Security Fixed Core	1600-114-A03
Access 3 High Security Fixed Core	1700-114-A03
Access 3 Patented Interchangeable Core	1580-114-A03
Access 3 Security Interchangeable Core	1680-114-A03
Access 3 High Security Interchangeable Core	1788-114-A03
Access 3 UL 6-Pin Housing	1078-114-A03

Note: Interchangeable core not available with 1-3/8" door thickness (D138) option and 2-3/8" backset (B238) option.

Deadlocks DL4100 Series

Padlocks & Deadlocks

Features

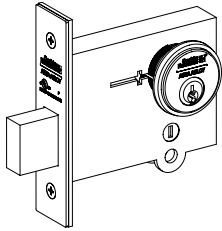

Handing

Non-handed.

Door Thickness

Standard: 1-3/4" (44mm). Optional door thicknesses available; see Quick Codes.

Backset

2-3/4" (70mm).

Lockcase

Heavy wrought steel; zinc dichromate finish.

Front

Brass, bronze, stainless steel.
4-5/8" (117mm) x 1-1/8" (29mm).
Adjustable for flat or beveled doors (bevel adjustment 1/8" (3mm) in 2" (51mm).

Deadbolt

Steel with hardened pin; 1" (25mm) throw.

Strike

Standard: wrought brass or bronze, 3-1/2" (89mm) x 1-1/8" (29mm).
Optional strikes available; see Strikes, this page.

Cylinder

6-pin, L4 keyway, 0-bitted. Security cylinder optional; see Quick Codes.

Keys

Two nickel silver standard.

Keying Features Available

Master keying
Construction master keying
7-pin (FC) conventional
Interchangeable core (IC)
Security
Security (IC)
Visual key control
Concealed key control
Pyramid (FC)
Pyramid (IC)

Warranty

One-year limited.

Certification/Compliance

UL

Listed for use on fire doors.

Any retrofit or other field modification to a fire rated opening can potentially impact the fire rating of the opening, and Corbin Russwin, Inc. makes no representations or warranties concerning what such impact may be in any specific situation. When retrofitting any portion of an existing fire-rated opening, or specifying and installing a new fire-rated opening, please consult with a code specialist or local code official (Authority Having Jurisdiction) to ensure compliance with all applicable codes and ratings.

Functions

Outside	Inside	Series/Function	Type	ANSI No.	Function Description
		DL4113	Single Cylinder	E6070 Series	- By key outside and by thumbturn inside.
		DL4112	Double Cylinder	E6060 Series	- By key either side.
		DL4117	Classroom	E6090 Series	- By key outside and by thumbturn inside. - Thumbturn will retract but not project deadbolt.
		DL4111	Cylinder x Blank	E6080 Series	- By key one side only; opposite side blank.
		DL4122	Double Cylinder x Thumbturn	—	- By key either side and by thumbturn inside. - Thumbturn will retract but not project deadbolt.
		DL4160	Thumbturn x Blank	—	- By thumbturn inside only; opposite side blank.

Strikes



Standard Strike

3-1/2" (89mm) x 1-1/8" (29mm).
To order separately, specify 796F34 x Finish.

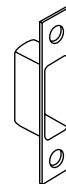

Strike Box

Optional with Standard Strike; see Quick Codes.
To order separately, specify 466F27-9.

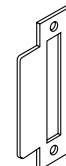

ANSI Strike

Optional; see Quick Codes. To order separately, specify 240L08 x Finish.

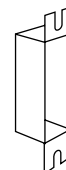

ANSI Wrought Strike Box

Optional for use with ANSI Strike; see Quick Codes. To order separately, specify 120F76-8.

Deadlocks DL4100 Series

Padlocks & Deadlocks

Ordering Examples

Stock Order

Quantity	Series/Function	Finish
24	DL4113	626

Contract/Detailed Order

Quantity	Keyset	Series/ Function	Finish	Optional Strike	Door Thickness	Misc. Options
7	AA13	DL4112	626	SS118	D234	C6-VKC2

Quick Codes

Finish

	Description	Specify
BHMA 605 (US3)	Bright Brass	605
BHMA 606 (US4)	Satin Brass	606
BHMA 611 (US9)	Bright Bronze	611
BHMA 612 (US10)	Satin Bronze	612
BHMA 613 (US10B)	Dark Oxidized Satin Bronze, Oil Rubbed	613
BHMA 613E (US10BE)	Dark Oxidized Satin Bronze - equivalent	613E
613L	Dark Oxidized Satin Bronze, Clear Coated	613L
BHMA 618 (US14)	Bright Nickel	618
BHMA 619 (US15)	Satin Nickel	619
BHMA 625 (US26)	Bright Chromium Plated	625
BHMA 626 (US26D)	Satin Chromium Plated	626

Strike

Lip to Center	ANSI Straight Lip Specify
7/8" (22mm)	SS078
1-1/8" (29mm)	SS118
1-1/4" (32mm)	SS114
1-3/8" (35mm)	SS138
1-1/2" (38mm)	SS112
1-3/4" (44mm)	SS134
2" (51mm)	SS200
2-1/4" (57mm)	SS214
2-1/2" (64mm)	SS212
2-3/4" (70mm)	SS234
3" (76mm)	SS300

Cylinder and Keying

Description	Specify
Conventional 6-pin	(standard)
Less cylinder(s)	LC
Conventional 7-pin	7P
Interchangeable core (IC) 6-pin	C6
IC 6-pin less core	CL6
IC 6-pin with temporary construction core	CT6
IC 7-pin	C7
IC 7-pin less core	CL7
IC 7-pin with temporary construction core	CT7
Security	HS
Security IC	CHS
Pyramid High Security Fixed Core	PHS
Pyramid High Security IC	PCHS
Pyramid Security Fixed Core	PS
Pyramid Security IC	PCS
Access 3® Patented Fixed Core	AP
Access 3® Security Fixed Core	AS
Access 3® High Security Fixed Core	AHS
Access 3® Patented IC	ACP
Access 3® Security IC	ACS
Access 3® High Security IC	ACHS
0-bitted with 2 blank keys	(standard)
Keyed random	KR
Construction master keyed	CMK
Visual key control (VKC)	
- Keys only	VKC1
- Cylinders and keys (not available with HS or CHS)	VKC2
- Cylinders only (not available with HS or CHS)	VKC3
Concealed key control (CKC)	
- CKC cylinders and VKC keys	CKC2
- CKC cylinders only	CKC3
UL IC 6-Pin Housing Less Core	CL6AH
UL IC 6-Pin Housing with Disposable Core	CTAHD
UL IC 6-Pin Housing with (Red/Blue/Green) Temporary Construction Core	CT6AH(R/B/G)
2 keys per lock	(standard)
More than 2 keys (e.g., KY6)	KY#

Deadlocks DL4100 Series

Padlocks & Deadlocks

Door Thickness

Description	Specify
1-3/4" (44mm) - 2" (51mm)	(standard)
2-1/4" (57mm)	D214
2-1/2" (64mm)	D212
2-3/4" (70mm)	D234
3" (76mm)	D300
3-1/4" (83mm)	D314
3-1/2" (89mm)	D312
3-5/8" (92mm)	D358
3-3/4" (95mm)	D334
3-7/8" (98mm)	D378
4" (102mm)	D400

Miscellaneous Options

Description	Specify
Spanner head screws	M02
Torx® head screws	M04
ANSI wrought strike box	M17
Lead wrapped case	M29
Ergonomic thumbturn	M34
Box for standard strike	M40

Cylinder Only

Specify Part No. x Keyway x Finish

Description	Number
Conventional 6-pin	1000-118-A07
Conventional 7-pin	1000-114-A07-7
IC 6-pin	1080-114-A07
IC 6-pin less core	1070-114-A07
IC 7-pin	1080-112-A07-7
IC 7-pin less core	1070-112-A07-7
Security	1010-118-A07
Security IC	1090-114-A07
Pyramid (FC) Conventional	1020-114-A07
Pyramid (IC)	1030-114-A07
Access 3® Patented Fixed Core	1500-114-A07
Access 3® Security Fixed Core	1600-114-A07
Access 3® High Security Fixed Core	1700-114-A07
Access 3® Patented Interchangeable Core	1580-114-A07
Access 3® Security Interchangeable Core	1680-114-A07
Access 3® High Security Interchangeable Core	1788-114-A07

ASSA ABLOY is the global leader in door opening solutions, dedicated to satisfying end-user needs for security, safety and convenience



ASSA ABLOY

In U.S.

Corbin Russwin
Architectural Hardware
225 Episcopal Road
Berlin, CT 06037
Phone: 800-543-3658
Fax: 800-447-6714
corbinrusswin.com

In Canada

ASSA ABLOY Door
Security Solutions Canada
160 Four Valley Drive
Vaughan, Ontario
Canada L4K 4T9
Phone: 800-461-3007
Fax: 905-738-2478
www.assaabloy.ca

For more information regarding Corbin Russwin Locksets, Exit Devices, Door Controls and Key Systems, contact your authorized Corbin Russwin Distributor or Sales Representative.

Corbin Russwin and Design® and Access 3® are registered trademarks of Corbin Russwin, Inc., an ASSA ABLOY Group company. Other products' brand names may be trademarks or registered trademarks of their respective owners and are mentioned for reference purposes only. These materials are protected under US copyright laws. All contents current at time of publication. Corbin Russwin, Inc., an ASSA ABLOY Group Company, reserves the right to change availability of any item in this catalog, its design, construction, and/or its materials. Copyright © 2001, 2013 Corbin Russwin, Inc., an ASSA ABLOY Group company. All rights reserved. Reproduction in whole or in part without the express written permission of Corbin Russwin, Inc. is prohibited.