

**Corbin
Russwin** 

ASSA ABLOY

CL3100 Series

Vandal Resistant Lever Locksets



ASSA ABLOY, the global leader
in door opening solutions



Overview

CL3100

Table of Contents

- Overview 2
- Features 3
- Functions 5
- Trim Designs 7
- Options and Accessories 8
- How to Order 11
- Quick Codes 12
- How to Specify 14

Quality

The CL3100 series is a Grade 1 lever lockset manufactured with the highest quality materials to ensure strength, durability and quiet operation. Available in all standard architectural finishes, the CL3100 series subtly complements any high-use commercial, industrial and institutional application.

T-Zone Construction

Direct linkage with fixed alignment between the hub and the latchbolt is the best construction for quietly and effectively operating the latchbolt. For this reason, Corbin Russwin interlocks the aligning and latch tubes, which form a rugged torque resistant “T” in the critical twist area. This “T-Zone” construction, combined with long lasting components, makes T-Zone Lever locks outstanding!

Vandal Resistance

The Corbin Russwin CL3100 Series* follows a higher standard for Grade 1 bored locks. The unique T-Zone construction provides strength and durability by true interlocking between the lockbody and the latch far exceeding the ANSI/BHMA A156.2 Series 4000 Grade 1 standards.

Applications

- High traffic areas
- Offices
- Public buildings
- Hospitals
- Institutions
- Educational facilities – K-12 and Universities
- Retail

Key Advantages

- Several security key systems available (Access 3®, Pyramid, etc.)
- Fits most standard door preps
- Only 45 degrees of lever rotation required to retract latchbolt
- 18 functions. Many of which are easily field changeable
- 3 levers and 4 roses available to cover a wide variety of door preps and design requirements
- Simple cylinder removal. Easy change outs.
- T-Zone construction tested to over 15 million cycles, exceeding ANSI/BHMA Grade 1 standards by 15 times.

* U.S. Patent No. 6,626,018



MicroShield®

As part of their promise to provide innovative solutions to their customers, certain ASSA ABLOY Group brands offer the MicroShield® technology, a silverbased antimicrobial coating designed to inhibit the growth of bacteria.

MicroShield® is a registered trademark of Yale Security Inc., an ASSA ABLOY Group company.

Features

Handing

Non-handed

Door Thickness

1-3/4" (44mm) - 2" (51mm) standard.
Optional: Over 2" (51mm) - 2-1/4" (57mm); see Quick Codes, page 12.

Door Prep

ANSI/BHMA A156.115 (161)

Lock Chassis

Steel, zinc dichromated for corrosion resistance.

Backset

2-3/4" (70mm) standard.
Optional: 3-3/4" (95mm) and 5" (127mm); see Quick Codes, page 12.

Bearing Assembly

Cast and machined stainless steel

Latchbolt

Stainless steel bolt 7/8" (22mm) diameter x 1/2" (13mm) throw.
Optional: 3/4" (19mm) throw fire latch.

Front

Wrought brass or stainless steel, 2-1/4" (57mm) x 1-1/8" (29mm).
Accommodates flat front doors and doors beveled 1/8" (3mm) in 2" (51mm).

Strike

Wrought brass or stainless steel ANSI curved lip standard, 4-7/8" (124mm) x 1-1/4" (32mm) x 1-1/4" (32mm) lip to center.

Optional: strikes, lip lengths and ANSI wrought strike box available.
See Quick Codes, page 12-13.

Levers

Secured with 6 lobe security set screw standard

Roses

Brass

Cylinder

Brass, 6-pin L4 keyway, 0-bitted standard.

Keying Features Available

Master keying
Construction master keying
Visual key control
Concealed key control
Interchangeable core (IC)
Security
Security IC (not available with CL3129)
Access 3® IC (not available with CL3129)
Pyramid (not available with CL3129)
Pyramid IC (not available with CL3129)

Keys

Two nickel silver standard.

Warranty

Ten-year limited.

Classroom Security

The CL3152 Classroom Intruder function is the solution to classroom security: a double cylinder lockset that allows locking of the outside lever from either side. Egress is always possible with the standard anti-panic feature, whether the door is locked or not. And because a key is needed to secure the door from either side, students cannot lock a teacher out of the classroom.



Sound Transmission Class Rated Product (M112)

Corbin Russwin CL3100 Series Lever Locks are part of the STC Acoustical Door Systems from ASSA ABLOY Group brand Security Metal Products (SMP). The STC Acoustical Door Systems are the perfect choice for any room where sound transmission needs to be kept to a minimum. This solution encompasses door, frame, sounds seals and threshold, and lock. All door systems use standard locks. The STC55 requires a special version of the CL3100 Lever Lock. To order the CL3100 Series Lever Lock for use with STC55 door system, include the M112 quick code in the order string and specify the C or K rose only. With this prefix, it will be configured for use with the Acoustical Door System. Functions are limited. See the M16 Option for available functions.

To learn more about SMP and the STC 55 Acoustical Door System, please visit www.secmet.com

Certification/Compliance

ANSI/BHMA

Exceeds A156.2 Series 4000, Grade 1.
Meets A117.1 Accessibility Code.



Federal

Meets FF-H-106C.

California State Reference Code

(Formerly Title 19, California State Fire Marshal Standard)

All levers with returns comply; levers return to within 1/2" (13mm) of door face.

UL-cUL

UL and cUL listed to Canadian Safety Standards
Listed for 3 Hour Doors

All locks with 1/2" (13mm) throw latchbolt listed for A label and lesser class 4' x 10' single doors. All locks with 3/4" (19mm) throw latchbolt listed for A label and lesser class 8' x 10' pairs of doors. Letter F and UL symbol on latch front indicate listing.

Any retrofit or other field modification to a fire-rated opening can potentially impact the fire-rating of the opening, and Corbin Russwin, Inc. makes no representations or warranties concerning what such impact may be in any specific situation. When retrofitting any portion of an existing fire-rated opening, or specifying and installing a new fire-rated opening, please consult with a code specialist or local code official (Authority Having Jurisdiction) to ensure compliance with all applicable codes and ratings.

A.D.A.

All levers conform to ADA requirements for barrier-free accessibility.





Windstorm

UL Listed: ANSI/SDI-BHMA A250.13; ANSI/ASTM E330-2002
ANSI/ASTM 31886-2005 & ASTM 31996-1009
UL Certification Directory ZHEM.R21744 Latching Hardware
Listed on Florida Building Code Website: FL4351-R1

Features

CL3100

Finishes

ANSI/BHMA 605 (US3)	Bright Brass	
ANSI/BHMA 606 (US4)	Satin Brass	
ANSI/BHMA 611 (US9)	Bright Bronze	
ANSI/BHMA 612 (US10)	Satin Bronze	
ANSI/BHMA 613 (US10B)	Dark Oxidized Satin Bronze, Oil Rubbed	
613E	Dark Oxidized Satin Bronze - equivalent	
613L	Dark Oxidized Satin Bronze, Clear Coated	
ANSI/BHMA 618 (US14)	Bright Nickel Plated	
ANSI/BHMA 619 (US15)	Satin Nickel Plated	
619C	Satin Nickel Plated with Microshield®	
ANSI/BHMA 625 (US26)	Bright Chromium Plated	
ANSI/BHMA 626 (US26D)	Satin Chromium Plated	
626C	Satin Chromium Plated with MicroShield®	
ANSI/BHMA 722 (US10A)	Black Oxidized Bronze, Oil Rubbed	

Zinc levers are plated to match BHMA finish.

MicroShield®

CL3100 series locks are available with MicroShield® antimicrobial coating. *MicroShield* is a revolutionary hardware finish coating, using a silver ion based technology, which inhibits the growth of bacteria, algae, yeast, fungus, mold and mildew. *MicroShield* is non-toxic and lasts for the lifetime of the finish to which it is applied. To order, suffix option code "YMS".

Note: MicroShield® coating may vary finish color from architectural standards. *MicroShield* is not intended as a substitute for traditional infection control programs such as hand hygiene or use of disinfectants. Coated product must still be cleaned to insure the surfaces will be free of destructive microbes. Corbin Russwin makes no representations or warranties, express or implied, as to the efficacy of the *MicroShield* antimicrobial.

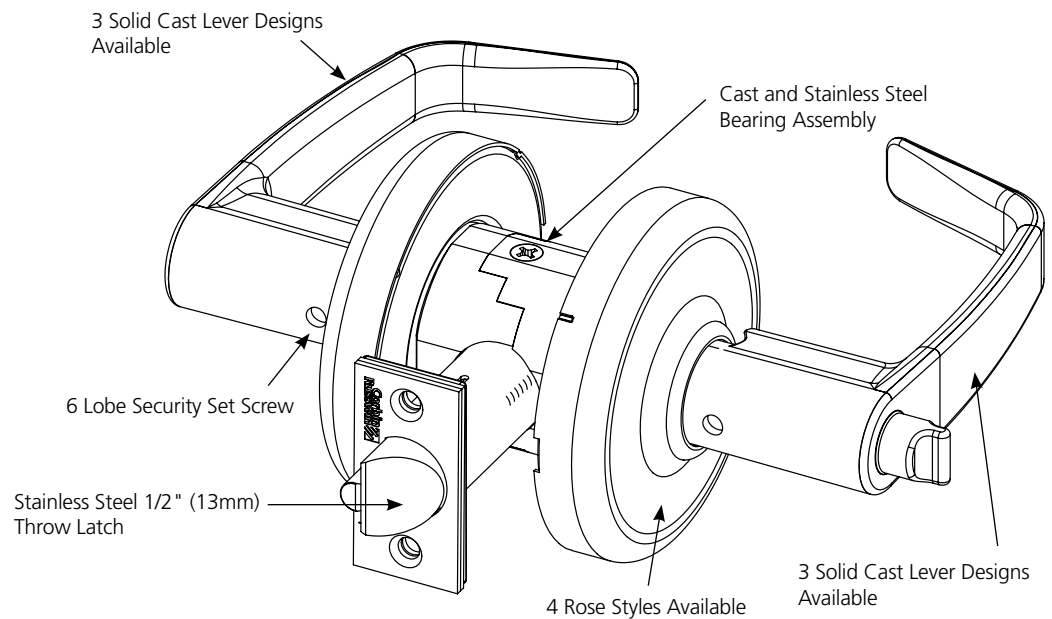

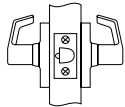
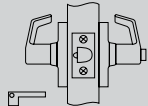
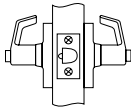
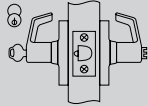
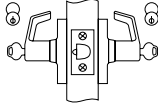
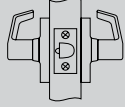
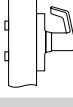
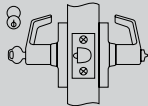
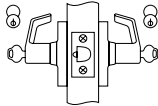

Outside	Inside	Series/ Function	Type	ANSI No.	Function Description
		CL3110	Passage or Closet	F75	<ul style="list-style-type: none"> Latchbolt by lever either side. Both levers always free.
		CL3120	Privacy, Bedroom or Bathroom	F76A	<ul style="list-style-type: none"> Throw-off latchbolt by lever. Outside lever locked by push button on inside lever. Outside lever unlocked by emergency release tool outside, by rotating inside lever or by closing door. Inside lever always free.
		CL3120H	Hospital Privacy	—	<ul style="list-style-type: none"> Outside lever locked by push button on inside lever. Outside lever unlocked by rotating thumbturn on outside lever and releasing inside push button. Rotating inside lever or closing door also unlocks outside lever.
		CL3129	Hotel or Motel	F93	<ul style="list-style-type: none"> Deadlocking latchbolt by lever inside or by key outside. Push button shuts out all keys except emergency key, and projects occupancy indicator in face of cylinder. Push button released by turning inside lever. Outside lever always locked. Inside lever always free. Not available with other manufacturers keyways Pushbutton will not depress unless door is in closed position Lockout key fixes pushbutton in locked position, shutting out all keys except emergency key. Lockout key ordered separately.
		CL3132	Institutional or Utility	F87	<ul style="list-style-type: none"> Deadlocking latchbolt by key either side. Should be used only in office or room with multiple entries.
		CL3140NT	Exit Latch	F89	<ul style="list-style-type: none"> Deadlocking latchbolt by lever inside. Outside lever always locked. Inside lever always free.
		CL3150	Half Dummy Trim	—	<ul style="list-style-type: none"> Lever acts as pull only; no operation. Lever is rigid.
		CL3151	Entrance or Office	F81	<ul style="list-style-type: none"> Deadlocking latchbolt by lever either side, except when turn button locks outside. Turning button locks outside lever, requiring key at all times. Turning inside lever does not unlock outside lever until button is manually turned to unlocked position. Inside lever always free.
		CL3152	Classroom Intruder	—	<ul style="list-style-type: none"> Deadlocking latchbolt by inside lever or outside lever except when key inside or outside locks outside lever. Key in either lever locks or unlocks the outside lever except when inside locks the outside lever - then only the inside key can unlock the outside lever. The outside key only retracts the latchbolt unless the outside lever is unlocked by the inside key. Inside lever always free.

 Indicates optional interchangeable core available; see Quick Codes, page 12.

Functions

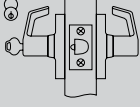
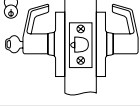
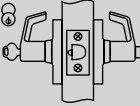
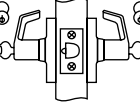
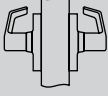
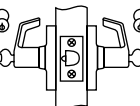
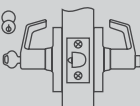
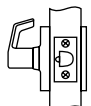
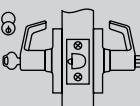
CL3100

Outside	Inside	Series/ Function	Type	ANSI No.	Function Description
		CL3155	Classroom	F84	<ul style="list-style-type: none"> • Deadlocking latchbolt by lever either side, except when key outside locks outside lever. • Outside lever locked or unlocked by key outside. • Inside lever always free.
		CL3157	Storeroom or Closet	F86	<ul style="list-style-type: none"> • Deadlocking latchbolt by key in outside lever or by rotating inside lever. • Inside lever always free. • Outside lever rigid at all times.
		CL3161	Entry or Office	F82A	<ul style="list-style-type: none"> • Deadlocking latchbolt by lever either side, except when push button locks outside lever. • Push button released by turning inside lever or by key in outside lever. • Closing door does not release push button. • Inside lever always free.
		CL3162	Communicating	F80	<ul style="list-style-type: none"> • Deadlocking latchbolt by lever either side, except when key in either lever locks and unlocks the lever independently of the other. • Keyed alike unless otherwise specified. • Should be used only in office or room with multiple entries.
		CL3170	Full Dummy Trim	—	<ul style="list-style-type: none"> • Levers act as pulls only; no operation. • Levers are rigid.
		CL3172	Apartment, Exit or Public Toilet	F88	<ul style="list-style-type: none"> • Deadlocking latchbolt by lever either side, except when key inside locks outside lever. • Key outside retracts latchbolt when outside lever is locked by key inside. • Key inside unlocks outside lever. • Inside lever always free. • Keyed alike unless otherwise specified.
		CL3175	Corridor/ Dormitory Lock	F90	<ul style="list-style-type: none"> • Throw-off latchbolt by lever either side except when pushbutton or key locks outside lever. • Pushbutton released by turning inside lever or by closing door. • Depressed pushbutton indicates door is locked. • When outside lever is locked by key, it can only be unlocked by key. • Inside lever always free. • Outside lever rigid when locked.
		CL3180	Passage Lever x Blank Plate	F111	<ul style="list-style-type: none"> • Latchbolt by lever. • Lever on one side; blank plate on other side. • Lever always free. • For single or double communicating doors.
		CL3193	Service Station	F92	<ul style="list-style-type: none"> • Deadlocking latchbolt by lever. • Outside lever locked by push button. • Key retracts latchbolt when outside lever is locked. • Pushbutton will not depress unless door is in closed position • Push button released by turning inside lever or by key in outside lever, unless pushbutton is fixed in locked position by turning coin slot in inside lever. • Inside lever always free.

 Indicates optional interchangeable core available; see Quick Codes, page 12.

Levers



Armstrong

Complies with codes requiring lever to return to within 1/2" (13mm) of door face.

AZD, AZC, AZE, or AZK



Lever: Die cast zinc
Rose: Brass

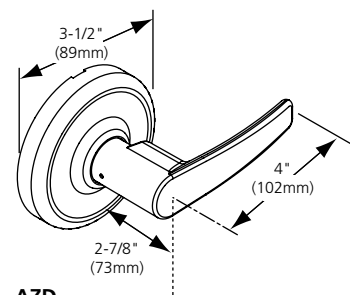

AZD

AZD shown



Newport

Complies with codes requiring lever to return to within 1/2" (13mm) of door face.

NZD, NZC, NZE, or NZK



Lever: Die cast zinc
Rose: Brass

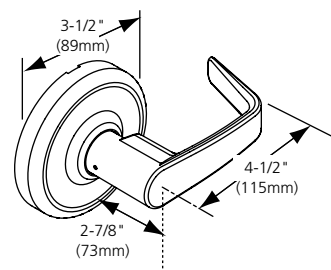

NZD

NZD shown

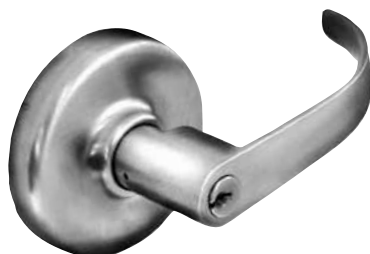

Princeton

Complies with codes requiring lever to return to within 1/2" (13mm) of door face.

PZD, PZC, PZE, or PZK



Lever: Die cast zinc
Rose: Brass

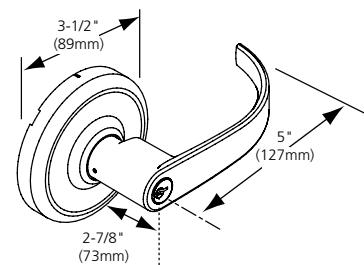

PZD

PZD shown

Roses

D Rose (standard)
3-1/2" Dia.
Brass



C Rose
2-3/4" Dia.
Brass



E Rose
3-1/8" Sq.
Brass



K Rose
2-3/4" Dia.
Brass



Options & Accessories

CL3100

Latches

To order optional latch with lockset, see Quick Codes, pages 12-13.
To order latch separately, specify Part No. x Finish (e.g., 780F81 x 626).

Part	Code	Functions
Standard 2-3/4" (70 mm) Backset		
780F81	A	10
780F82	B	32, 40NT, 51, 52, 55, 57, 62, 72, 80
780F83	C	20, 20H
780F84	D	29, 75, 93
780F85	K	61
B334 option 3-3/4" (95mm) Backset		
780F86	A	10
780F87	B	32, 40NT, 51, 52, 55, 57, 62, 72, 80
780F88	C	20, 20H
780F89	D	29, 75, 93
780F90	K	61
B500 option 5" (127mm) Backset		
780F91	A	10
780F92	B	32, 40NT, 51, 52, 55, 57, 62, 72, 80
780F93	C	20, 20H
780F94	D	29, 75, 93
780F95	K	61
M16 option 3/4" (19mm) Throw*		
780F96	—	10, 51, 55, 57, 72, 80

Note: Code letter stamped on inside corner of latch front identifies function(s) compatible with latch assembly.

*Limited to 2-3/4" Backset only

Corbin Russwin Cylinders

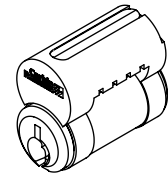
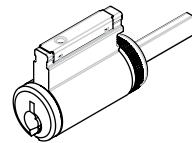

Security Type	Pins	Standard Cylinder	Interchangeable Core
Conventional	6-Pin	2000-031 (standard)	8000
	7-Pin	2000-031-7	8000-7
Hotel	6-Pin	2001-031	8001-031
	7-Pin	2001-031-7	8001-031-7
Security	6-Pin	2010-031	8010
Pyramid - High Security	7-Pin	2020-031	8020
Pyramid - Security	7-Pin	2027-031	8027
Access 3 - Patented (AP)	6-Pin	2500-031	8500
Access 3 - Security (AS)	6-Pin	2600-031	8600
Access 3 - High Security (AHS)	6-Pin	2700-031	8700
Access 3 - AP (Hotel Function)	6-Pin	2501-031	N/A
Access 3 - AS (Hotel Function)	6-Pin	2601-031	N/A
Access 3 - AHS (Hotel Function)	6-Pin	2701-031	N/A

Plug diameter for standard and Access 3® cylinders is .509, .552 for security cylinders and .496 for Pyramid cylinders.

Cylinders are brass and come with 2 nickel silver keys.

Finishes for standard cylinders include 606 or 626. Finishes for interchangeable core cylinders include 605, 606, 611, 612, 613, 613E, 625, 626.

To order cylinders separately, specify Part No. x Keyway x Finish (e.g., 2000-031 x L4 x 626).

Cylinders with Keyways From Other Manufacturers*

Competitive Keyway	Number
Schlage® C (0-bitted)	2400-031-C
Schlage® C (keyed random)	2400-031-C-KR
Sargent® LA (0-bitted only)	2400-031-LA

*0-Bitted cylinders are 6-pin. Keyed random cylinders are 5-pin only.

Levers That Accept Interchangeable Core Cylinders From Other Manufacturers*

Cylinder Type	Quick Code	Part Number
SFIC 6 or 7-pin Cylinder	Specify M08	780F658 Tailpiece Kit
Schlage® LFIC 6-pin Cylinder	Specify M69	780F662 Tailpiece Kit

*Cylinder not included.

Adapters Required to Accept Cylinders From Other Manufacturers*

Competitive Cylinder	Part Number
Schlage® Conventional (21-002, 23-001, 23-013) or Primus® (20-548, 20-550, 20-748, 20-750)	778F78-8 Tailpiece included with M06 option
Sargent® 13-4145	775F948 Tailpiece kit and special lever included with M09 option

*Cylinder not included.

Options & Accessories

CL3100

Strikes

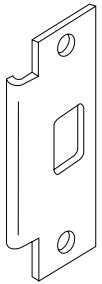

ANSI Curved Lip (standard)

Brass or stainless steel.

4-7/8" (124mm) x 1-1/4" (32mm) x 1-1/4" (32mm)
lip to center.

Optional lip lengths: 1" (25mm), 1-1/8" (29mm),
1-3/8" (35mm), 1-1/2" (38mm), 1-3/4" (44mm), 2"
(51mm), 2-1/4" (57mm), 2-1/2" (64mm), 2-3/4"
(70mm), 3" (76mm).

To order separately, specify
217L13 x Lip Length x Finish.

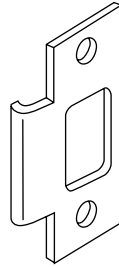

Curved Lip "T" Strike (option)

Brass.

2-3/4" (70mm) x 1-1/8" (29mm) x 1-1/4" (32mm) lip
to center

Optional lip lengths: 1" (25mm), 1-1/8" (29mm),
1-3/8" (35mm), 1-1/2" (38mm), 1-3/4" (44mm),
2" (51mm), 2-1/4" (57mm), 2-1/2" (64mm), 2-3/4"
(70mm), 3" (76mm)

To order optional strike with lockset, see Quick
Codes, page 12.

To order separately, specify 586L19 x
Lip Length x Finish.

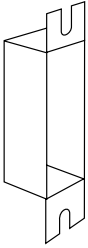

ANSI Wrought Strike Box

To order with lockset, see Quick Codes, page 13.

To order separately, specify 120F76-8.

Ordering Examples

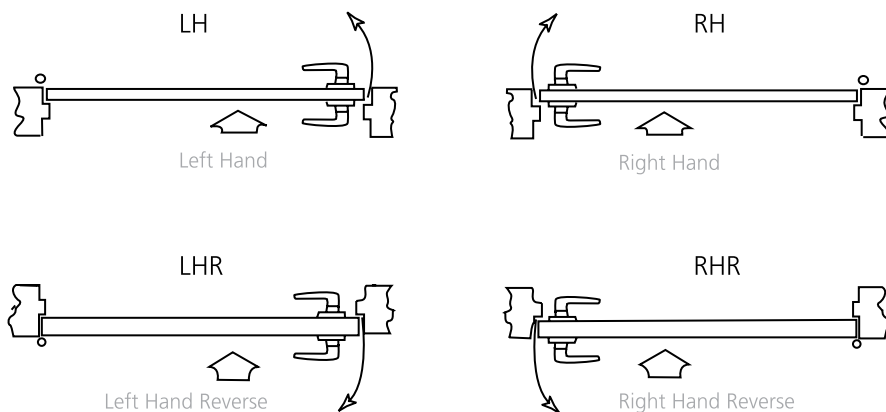

Where to find ordering information and quick codes

Series/Function	Pages 5-6
Trim Designs	Page 7
Latches	Page 8
Finish	Page 12
Door Thickness	Page 12
Backset	Page 12
Strike	Page 10
Cylinders and Keying	Page 12
Miscellaneous Options	Page 12

Stock Order

Quantity	Series/Function	Trim	Finish	Hand
100	CL3155	NZD	626	RHR

Split Trim / Finish Order

Quantity	Series/Function	Trim		Finish		Hand
		Outside	Inside	Outside	Inside	
12	CL3155	NZD	NZD	626	625	LH

Contract / Detailed Order

Quantity	Keypad	Series/Function	Trim	Finish	Hand	Door Thickness	Backset	Optional Strike	Misc. Options	Optional Cylinder	Keying
24	AA1	CL3155	NZE	626	RHR	D214	B334	SC114	M04-M16	C6	VKC3

Quick Codes

CL3100

Cylinder and Keying

Description	Specify
Conventional 6-pin	(standard)
Conventional 7-pin	7P
Less cylinder(s)	LC
IC 6-pin	C6
IC 6-pin with Temporary Construction Core (Red)	CT6R
IC 6-pin with Temporary Construction Core (Blue)	CT6B
IC 6-pin with Temporary Construction Core (Green)	CT6G
IC 6-pin with temporary construction core	CT6
IC 6-pin less core ³	CL6
IC 7-pin	C7
IC 7-pin with temporary construction core	CT7
IC 7-pin less core ³	CL7
IC 7-pin with Temporary Construction Core (Red)	CT7R
IC 7-pin with Temporary Construction Core (Blue)	CT7B
IC 7-pin with Temporary Construction Core (Green)	CT7G
Security ³	HS
Security IC ³	CHS
Access 3 [®] Patented Fixed Core	AP
Access 3 [®] Security Fixed Core	AS
Access 3 [®] High Security Fixed Core	AHS
Access 3 [®] Patented IC ³	ACP
Access 3 [®] Security IC ³	ACS
Access 3 [®] High Security IC ³	ACHS
Pyramid High Security Fixed Core ³	PHS
Pyramid High Security IC ³	PCHS
Pyramid IC Less Core ³	CLP
Pyramid with temporary construction core ³	CTP
Pyramid Security Fixed Core ³	PS
Pyramid Security IC ³	PCS
Pyramid Disposable Core ³	CTPD
6-Pin Disposable Core ³	CT6D
7-Pin Disposable Core ³	CT7D
0-bitted with 2 blank keys	(standard)
Keyed random	KR
Construction master keyed	CMK
Visual key control (VKC)	
No biting or keyset stamping on keys	VKC0
Keys only	VKC1
Cylinders and keys (not for HS, CHS, PHS or PCHS)	VKC2
Cylinders only (not for HS, CHS, PHS or PCHS)	VKC3
Concealed key control (CKC)	
CKC cylinders with VKC keys	CKC2
CKC cylinders only (not for PHS, PCHS)	CKC3
2 keys per lock	(standard)
More than 2 keys	KY# (e.g., KY6)

Cylinder and Keying from other Manufacturers

Description	Specify
SFIC 6- or 7-pin Small Format Disposable Core ²	CTSD
Schlage [®] C keyway cylinder ¹	C
Sargent [®] LA keyway cylinder ²	LA

1 Available 0-bitted & keyed random (KR) only

2 Available 0-bitted only

3 Not available in CL3129 functions

Finishes

Description	Specify
ANSI/BHMA 605 (US3) Bright Brass	605
ANSI/BHMA 606 (US4) Satin Brass	606
ANSI/BHMA 611 (US9) Bright Bronze	611
ANSI/BHMA 612 (US10) Satin Bronze	612
ANSI/BHMA 613 (US10B) Dark Oxidized Satin Bronze, Oil Rubbed	613
613E Dark Oxidized Satin Bronze - equivalent	613E
613L Dark Oxidized Satin Bronze, Clear Coated	613L
ANSI/BHMA 618 (US14) Bright Nickel Plated	618
ANSI/BHMA 619 (US15) Satin Nickel Plated	619
619C Satin Nickel Plated with MicroShield [®]	619C
ANSI/BHMA 625 (US26) Bright Chromium Plated	625
ANSI/BHMA 626 (US26D) Satin Chromium Plated	626
626C Satin Chromium Plated with MicroShield [®]	626C
ANSI/BHMA 722 (US10A) Black Oxidized Bronze, Oil Rubbed	722

Strikes

ANSI Lip to Center	ANSI Curved Lip Specify	T-Strike Curved Lip Box Specify
1" (25mm)	SA100	SC100
1-1/8" (29mm)	SA118	SC118
1-1/4" (32mm)	(standard)	SC114
1-3/8" (35mm)	SA138	SC138
1-1/2" (38mm)	SA112	SC112
1-3/4" (44mm)	SA134	SC134
2" (51mm)	SA200	SC200
2-1/4" (57mm)	SA214	SC214
2-1/2" (64mm)	SA212	SC212
2-3/4" (70mm)	SA234	SC234
3" (76mm)	SA300	SC300

Door Thickness

Door Thickness	Specify
1-3/4" (44mm) - 2" (51mm)	(standard)
Over 2" (51mm) - up to 2 1/4" (57mm)	D214

Backset

Description	Specify
2-3/4" (70mm)	(standard)
3-3/4" (95mm)	B334
5" (127mm)	B500

Miscellaneous Options

Description	Specify
Spanner head screws	M02
Torx® head screws	M04
Less cylinder, with tailpiece for Schlage® cylinder	M06*
Lever to accept SFIC 6 or 7-pin interchangeable core	M08*
Lever to accept Sargent® cylinder	M09*
3/4" (19mm) throw fire latch	M16
ANSI wrought strike box	M17
Knurling outside and inside	M20
Knurling outside only	M21
Knurling inside only	M22
Abrasive coat outside and inside	M23
Abrasive coat inside only	M24
Abrasive coat outside only	M25
Lead lining (roses)	M28
Lever to accept Schlage® LFIC	M69*
Security Lever	M111
STC 55 Door Kit	M112

*Not available in CL3129 functions

How To Specify

CL3100

CL3100 Series Suggested Specification

All locksets shall be CL3100 Series Vandal Resistant Lever Locksets as manufactured by Corbin Russwin Architectural Hardware.

A single lock chassis shall accommodate 1-3/4" (44mm) to 2-1/4" (57mm) door thickness. Locksets shall be non-handed.

Locksets shall be able to withstand 3000 inch pounds of torque applied to the locked lever without gaining access.

Locksets shall have solid cast levers without plastic fillers. Outside lever handles shall be a minimum of 4-5/8" (117mm) in length and shall provide a minimum of 2" (51mm) clearance from the surface of the door to the inside of the lever at the midpoint. Outside lever handles may return to within 1/2" (13mm) of the door surface. Levers on keyed locksets shall be removable only when the designated key is in the cylinder.

Locksets shall be able to fit a standard 2-1/8" (55mm) bore without the use of thru-bolts. Standard rose size shall be 3-1/2" (89mm) in diameter.

Latchbolt head shall be one piece stainless steel. Latchbolt assembly shall be encased within the lock body.

Lockset shall have 2-3/4" (70mm) backset, standard.

A single lockset shall accommodate a 6 or 7-pin conventional cylinder and all levers of master keying, construction master keying, visual key control, security, high security and interchangeable core. Cylinders may be easily changed by removing the lever without disassembling the lockset.

Locksets required for fire doors shall be listed by UL for ratings of A label (3 hours) and less, for doors up to 4'0" (1.2m) x 10'0" (3m) and pairs of doors 8'0" (2.4m) x 10'0" (3m). A 3/4" (19mm) throw Latchbolt for pairs of fire doors shall be standard.

Locksets shall be cycle tested per ANSI A156.2, to eight (8) million cycles without any visible lever sag.

Certification:

Meets FF-H-106C

Exceeds ANSI/BHMA A156.2 Series 4000, Grade 1

UL and cUL listed to Canadian safety standards

UL-cUL listed for 3 Hour doors

All levers conform to ADA requirements for barrier free accessibility

Meets UL 10C and UBC 7-2

UL Listed: ANSI/SDI-BHMA A250.13;ANSI/ASTM E330-2002

ANSI/ASTM 31886-2005 & ASTM 31996-1009

UL Certification Directory ZHEM.R21744 Latching Hardware

Listed on Florida Building Code Website: FL4351-R1

Meets ANSI A117.1 Accessibility Code.

California State Reference Code (formerly Title 19, Cal. State Fire Marshal Standard).

Lockset shall carry a ten (10) year limited warranty.

ASSA ABLOY is the global leader in door opening solutions, dedicated to satisfying end-user needs for security, safety and convenience



ASSA ABLOY

In U.S.

Corbin Russwin
Architectural Hardware
225 Episcopal Road
Berlin, CT 06037
Phone: 800-543-3658
Fax: 800-447-6714
corbinrusswin.com

In Canada

ASSA ABLOY Door
Security Solutions Canada
160 Four Valley Drive
Vaughan, Ontario
Canada L4K 4T9
Phone: 800-461-3007
Fax: 905-738-2478
www.assaabloy.ca

For more information regarding Corbin Russwin Locksets, Exit Devices, Door Controls and Key Systems, contact your authorized Corbin Russwin Distributor or Sales Representative.

Hardwiring Made Easy®



ElectroLynx®

As part of their promise to provide innovative, fast and effective high security solutions to their customers, certain ASSA ABLOY Group brands offer ElectroLynx®, a universal quick-connect system that simplifies the electrification of the door opening.

ElectroLynx® is a registered trademark of ASSA ABLOY Inc.



MicroShield®

As part of their promise to provide innovative solutions to their customers, certain ASSA ABLOY Group brands offer the MicroShield® technology, a silverbased antimicrobial coating designed to inhibit the growth of bacteria.

MicroShield® is a registered trademark of Yale Security Inc., an ASSA ABLOY Group company.

Corbin Russwin and Design® and Access 3® are registered trademarks of Corbin Russwin, Inc., an ASSA ABLOY Group company. Lever Release™ is a trademark of Corbin Russwin, Inc., an ASSA ABLOY Group company. Other products' brand names may be trademarks or registered trademarks of their respective owners and are mentioned for reference purposes only. These materials are protected under US copyright laws. All contents current at time of publication. Corbin Russwin, Inc., an ASSA ABLOY Group Company, reserves the right to change availability of any item in this catalog, its design, construction, and/or its materials. Copyright © 2012, 2014 Corbin Russwin, Inc., an ASSA ABLOY Group company. All rights reserved. Reproduction in whole or in part without the express written permission of Corbin Russwin, Inc. is prohibited.