

ZIP2B

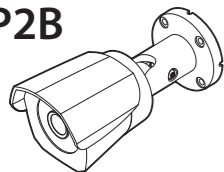

2.0MP Full-HD IP Indoor/Outdoor Mini Bullet Camera

Quick Manual

Ver. 0.5 / 2013.11

Before installing and using the camera, please read this manual carefully. Be sure to keep it handy for future reference.



This equipment has been tested and found to comply with the limits for a Class A digital device, pursuant to part 15 of the FCC Rules. These limits are designed to provide reasonable protection against harmful interference when the equipment is operated in a commercial environment. This equipment generates, uses, and can radiate radio frequency energy and, if not installed and used in accordance with the instruction manual, may cause harmful interference to radio communications. Operation of this equipment in a residential area is likely to cause harmful interference in which case the user will be required to correct the interference at his own expense.

1. Product & Accessories

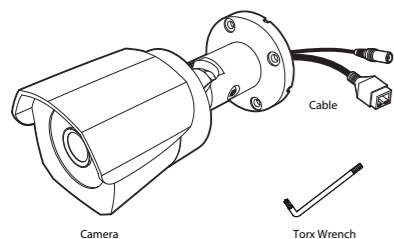

Camera

Cable



Torx Wrench



Manual CD



Screw & Plastic Anchor-4pcs

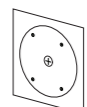

Template Sheet



Quick Manual

Safety Information

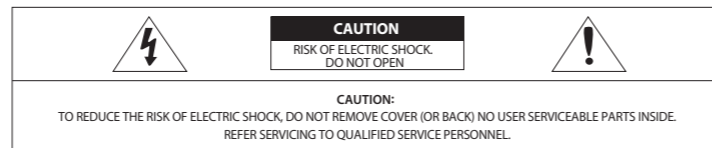

CAUTION:
TO REDUCE THE RISK OF ELECTRIC SHOCK, DO NOT REMOVE COVER (OR BACK) NO USER SERVICEABLE PARTS INSIDE.
REFER SERVICING TO QUALIFIED SERVICE PERSONNEL.

This symbol indicates that dangerous voltage consisting a risk of electric shock is present within this unit.

This exclamation point symbol is intended to alert the user to the presence of important operating and maintenance (servicing) instructions in the literature accompanying the appliance.

WARNING

To prevent damage which may result in fire or electric shock hazard, do not expose this appliance to rain or moisture.

WARNING

- Be sure to use only the standard adapter that is specified in the specification sheet. Using any other adapter could cause fire, electrical shock, or damage to the product.
- Incorrectly connecting the power supply or replacing battery may cause explosion, fire, electric shock, or damage to the product.
- Do not connect multiple cameras to a single adapter. Exceeding the capacity may cause abnormal heat generation or fire.
- Securely plug the power cord into the power receptacle. Insecure connection may cause fire.
- When installing the camera, fasten it securely and firmly. A falling camera may cause personal injury.
- Do not place conductive objects (e.g. screw drivers, coins, metal things, etc.) or containers filled with water on top of the camera. Doing so may cause personal injury due to fire, electric shock, or falling objects.

2. Part Name

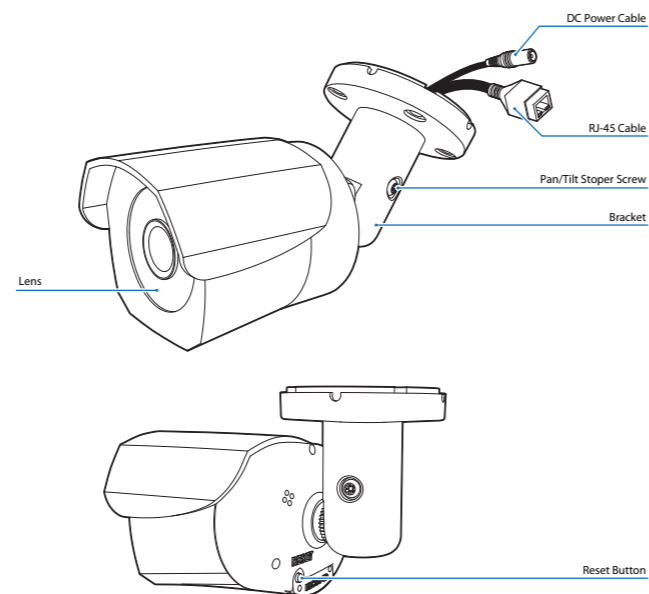

- Do not install the unit in humid, dusty, or sooty locations. Doing so may cause fire or electric shock.
- If any unusual smells or smoke come from the unit, stop using the product. In such case, immediately disconnect the power source and contact the service center. Continued use in such a condition may cause fire or electric shock.
- If this product fails to operate normally, contact the nearest service center. Never disassemble or modify this product in any way.
- When cleaning, do not spray water directly onto parts of the product. Doing so may cause fire or electric shock.
- To disconnect power from the mains, pull out the mains cord plug. When install the product, ensure that the plug is easily accessible.

CAUTION

- Do not drop objects on the product or apply strong shock to it. Keep away from a location subject to excessive vibration or magnetic interference.
- Do not install in a location subject to high temperature (over 122 degrees F), low temperature (below 14 degrees F), or high humidity. Doing so may cause fire or electric shock.
- If you want to relocate the already installed product, be sure to turn off the power and then move or reinstall it.
- Remove the power plug from the outlet when there is a lightning. Neglecting to do so may cause fire or damage to the product.
- Keep out of direct sunlight and heat radiation sources. It may cause fire.
- Install it in a place with good ventilation.
- Avoid aiming the camera directly towards extremely bright objects such as sun, as this may damage the CMOS image sensor.
- Apparatus shall not be exposed to dripping or splashing and no objects filled with liquids, such as vases, shall be placed on the apparatus.
- The Mains plug is used as a disconnect device and shall stay readily operable at any time.

3. Installation

Before installing your camera, you have to read the following cautions.

- You have to check whether the location can bear five times of the weight of your camera.
- Don't let the cable get caught in improper place or the electric line cover get damaged. Otherwise it may cause a breakdown or fire.
- When installing your camera, don't allow any person to approach the installation site. If you have any valuable things under the place, move them away.

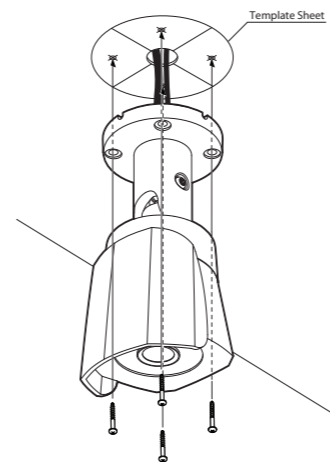

- To pass cables through the wall/ceiling, drill holes on the ceiling panel.
- Connect the network cable, power cable respectively. See the section Cabling for details.
- Fix the camera on the wall/ceiling using the screws provided.
 - Loosen the Pan/Tilt stoper screw a little before fixing the camera.
- After adjusting the view angle, tighten the Pan/Tilt stoper screw.

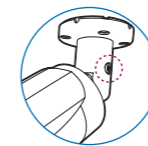

Important Safety Instructions

WARNING

- Read these instructions.
- Keep these instructions.
- Heed all warnings.
- Follow all instructions.
- Do not use this apparatus near water.
- Clean only with dry cloth.
- Do not block any ventilation openings. Install in accordance with the manufacturer's instructions.
- Do not install near any heat sources such as radiators, heat registers, or other apparatus (including amplifiers) that produce heat.
- Do not defeat the safety purpose of the polarized or grounding-type plug. A polarized plug has two blades with one wider than the other. A grounding type plug has two blades and a third grounding prong. The wide blade or the third prong is provided for your safety. If the provided plug does not fit into your outlet, consult an electrician for replacement of the obsolete outlet.
- Protect the power cord from being walked on or pinched particularly at plugs, convenience receptacles, and the point where they exit from the apparatus.
- Only use attachments/accessories specified by the manufacturer.
- Refer all servicing to qualified service personnel. Servicing is required when the damaged in any way, such as power supply cord or plug is damaged, liquid has been spilled or objects have fallen into the apparatus, the apparatus has been exposed to rain or moisture, does not operate normally, or has been dropped.

apparatus has been

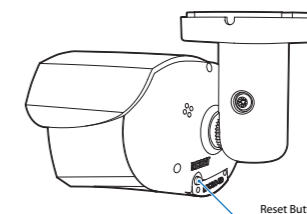

Reset to the Factory Default

Press the reset button for 5 seconds to return the setup to the factory default.

Warning:

If you press the 'Reset' button, you will lose all setting data. If needed, please, make a note for further installation.

4. Cabling

Two Options

Use a PoE-enabled switch to connect data and power through a single cable and begin viewing and recording images instantly. A non-PoE switch will require an adaptor for power transmission.

1. Using a PoE-Enabled Switch

The Camera is PoE-compliant, allowing transmission of power and data via a single Ethernet cable. PoE eliminates the need for the different cables used to power, record, or control the camera. Follow the illustration below to connect the camera to a PoE-enabled switch using an Ethernet cable.

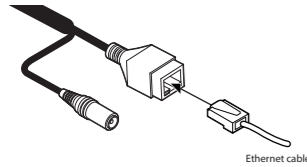

Ethernet cable

2. Using a Non-PoE Switch

If a PoE-enabled switch is not used, use a power adaptor for power transmission and non-PoE switch for data transmission. Follow the illustrations below to connect the camera without a PoE-enabled Switch. switch using an Ethernet cable.

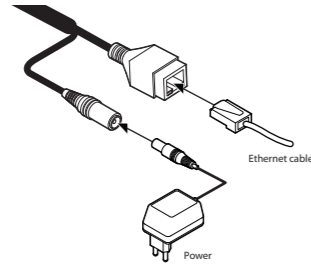

Power

Disposal of Old Appliance



1. All electrical and electronic products should be disposed of separately from the municipal waste stream in accordance to laws designated by the government or the local authorities.
2. The correct disposal of your old appliance will help prevent potential negative consequences for the environment and human health.
3. For more detailed information about disposal of your old appliance, please contact your city office, waste disposal service or the shop where you purchased the product.

5. IP Camera Setup via SpecoTech Multi-Client CMS Software

The menu settings for the ZIP2B can be set over network using SpecoTech Multi-Client CMS software. Put the cursor of the mouse on the channel, which is connected to the site and right click on the mouse to open the submenu. Then the following window is displayed as below. Select the IP CAMERA SETUP.

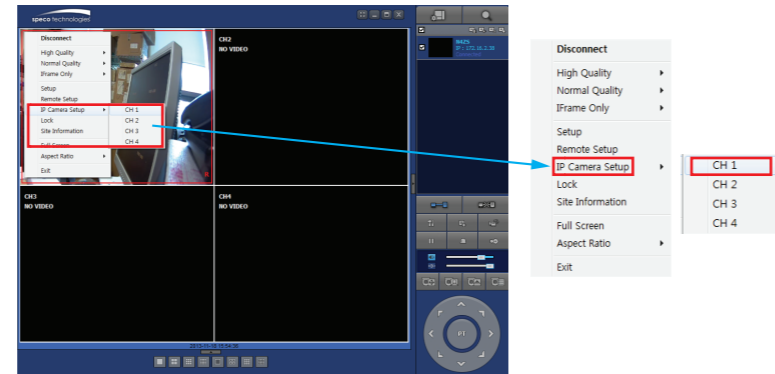

Then the setup window is displayed. The specified menu screen is displayed on the upper left of the screen. Enter the ID and Password of the IP Camera when prompted. (NOTE: The default ID : "admin" and Password is "1111")

6. Web Viewer Screen

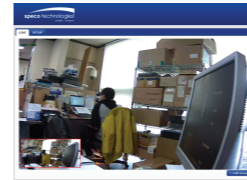

Live View using Internet Explorer



VIDEO Stream (MAIN/SUB)



Security

Open Internet Explorer and enter camera's IP address. The system will ask for confirmation to install Active-X control. Once authorized, the Internet Explorer will start to display video images from camera as shown below

Stream profile :

The standard defines various sets of capabilities, which are referred to as profiles, targeting specific classes of applications.

Resolution :

Select video compression resolution.

Frame rate :

Determine the maximum number of frames of video images to compress.

Bit rate :

Selectable video Bit rate.

USER :

User can be registered and privilege level of a user can be specified.

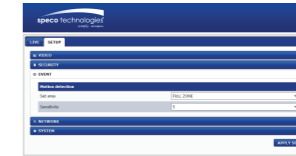

Event



Network

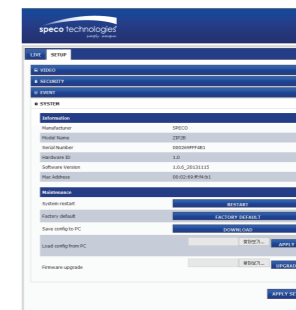

System

Motion Detection :

Select Motion Detection function.

SET AREA :

Configure regions for motion detection.

Sensitivity :

Set the condition to trigger an event for motion detection.

Network Type :

Select the Network Type(DHCP, Static)

DHCP :

The address setting mode is automatic.

STATIC :

The address setting mode is manual. Input IP, Gateway, Subnet Mask, and DNS IP

Information

Manufacturer
Model Name
Serial Number
Hardware ID
Software Version
MAC Address

Maintenance

System restart

Pressing Reboot Server button will cause the system to reboot.

Factory Default

Set all settings to the factory default values.

Save Config to PC

All the setting of configuration can be stored.

Load Config from PC

Stored configuration can be browsed and restored.