

ACCESS CONTROL » PRODUCTS

MAG LOCKS

ELECTROMECH
LOCKS

SPECIALTY LOCKS

EXIT DEVICES

ENTRY DEVICES

ACCESS CONTROL
ACCESSORIES

POWER SUPPLIES

POWER TRANSFER

POWER
ACCESSORIES

RESOURCES

SECURITRON®
ASSA ABLOY

ASSA ABLOY, the global leader in door opening solutions

MAG LOCKS

**Electromagnetic Locks & Accessories**

M380, M370, M670, M680, M38, M68, M34R, M32, M62, DM62, M82B, SAM, iMXDa, Component EXD, XDT/SB-MXD, Brackets & Accessories, Vista® VM300, VM600, VM1200/VM1290, Vista Brackets

ELECTROMECH
LOCKS**Electromechanical Locks**

MM15, UNL, MUNL

SPECIALTY LOCKS

**Gate Locks, Cabinet Locks & Accessories**

SAM2-24, M62FG-SASM, GL1, FMK, MCL, M32-SS

EXIT DEVICES

**Exit Devices**

DSB, TSB, TSH, SP-1, EMB, EMH, PB Series, EEB, XMS

ENTRY DEVICES

**Entry Devices**

WSS, R100-1H, DK-12, DK-16, DK-26, DKC, DK-37/38, Keypad Accessories

ACCESS CONTROL
ACCESSORIES**Access Control Accessories**

Keyswitch Series, DPS, MSS, LM/RLP, RB, TM-2/TM-9, DT7/PZ-1, DPA

POWER SUPPLIES

**Power Supplies**

BPS-12/24-1, BPS, BPSM, BPSS, PSM, PSP, BACS, AQTV, AQD3, AQD5, AQD6, AQM20, AQU126, AQU128, AQU243, AQU244, AQE PoE, AQ Power Boards, PDB, PDB-1R/ PDB-8C1R, PDB-8F8R/8C8R

POWER TRANSFER

**Power Transfer**

ICPT, EH, CEPT, EPT, SEPT

POWER
ACCESSORIES**Power Accessories**

TSB-C, FAR, B-12-5, B-24-5, BR-4, CCB-8, CKL

RESOURCES

**Resources & Extras**

Tech Support, AHJ Handbook Information, Building Codes Appendix, Terms Glossary, Icon Glossary, Code-Compliant Systems, Demo Mounts, Terms and Conditions, Index, Warranty



PRODUCT FEATURES

- Redundant switches
- Release triggered by either 1/8" mechanical movement or reliable touch sense technology
- Optional MicroShield Anti-microbial coating ideal for infection control in health care environments
- Resistant to interference from radio frequency or electromagnetic frequency and external impact/bounce attempts
- All metal construction
- Can be field cut to fit non-standard door widths
- 16 ft. [4.8m] 22AWG 6 conductor cable and armored door cord included
- Automatic dual voltage 12VDC or 24VDC
- Resists electrostatic discharge up to 27,000 volts
- MagnaCare Lifetime Replacement No Fault Warranty

PRODUCT OPTIONS

- 36" Length
- 42" Length
- 48" Length

- EL- Prefix any model for ElectroLynx® ready
- -I Add to any model for Illuminated via fiber optics
- -A Add to any model for MicroShield Anti-microbial coating
- Through-bolt kit for doors 1-3/4" to 2-1/4" thick

SPECIFICATIONS

- CAN/ULC-S533 Listed
- ANSI/UL 294 Listed
- CSA-C22.2 No.205 Listed
- NFPA 101
- Patent pending

Electrical:
Dual Sense Bar Only -
24mA at 12VDC or 24VDC

Dual Sense Bar with Illumination -
44mA at 12VDC or 24VDC

Operating Temperature:
+32 to +120F [0 to +49C]
Recommended for indoor use only

Shipping Weight:
6lbs [2.72kg] to 8lbs [3.63kg]
depending on length

Finishes:
BK - Black anodized
CL - Clear anodized



DSB

Dual Sense Bar

Dependable Touch and Mechanical Release for Superior Safety and Redundancy

The dependable DSB Dual Sense Bar is the most reliable exit device available for magnetically locked, non-fire-rated doors. Its unique design delivers superior fault tolerance with two independent, redundant switch circuits for releasing the lock. The DSB can be installed on all types of interior metal, aluminum or wood doors. Meets "no special tools or knowledge" criteria required by code.

MODELS

PART #	Description
DSB-BK	DSB - 36", Black Anodized
DSB-BK42	DSB - 42", Black Anodized
DSB-BK48	DSB - 48", Black Anodized
DSB-BKA	DSB - 36", Black Anodized, Anti-Microbial
DSB-BKA42	DSB - 42", Black Anodized, Anti-Microbial
DSB-BKA48	DSB - 48", Black Anodized, Anti-Microbial
DSB-BKI	DSB - 36", Illuminated, Black Anodized
DSB-BKI42	DSB - 42", Illuminated, Black Anodized
DSB-BKI48	DSB - 48", Illuminated, Black Anodized
DSB-BKIA	DSB - 36", Illuminated, Black Anodized, Anti-Microbial
DSB-BKIA42	DSB - 42", Illuminated, Black Anodized, Anti-Microbial
DSB-BKIA48	DSB - 48", Illuminated, Black Anodized, Anti-Microbial
DSB-CL	DSB - 36", Clear Anodized
DSB-CL42	DSB - 42", Clear Anodized
DSB-CL48	DSB - 48", Clear Anodized
DSB-CLA	DSB - 36", Clear Anodized, Anti-Microbial
DSB-CLA42	DSB - 42", Clear Anodized, Anti-Microbial
DSB-CLA48	DSB - 48", Clear Anodized, Anti-Microbial
DSB-CLI	DSB - 36", Illuminated, Clear Anodized
DSB-CLI42	DSB - 42", Illuminated, Clear Anodized
DSB-CLI48	DSB - 48", Illuminated, Clear Anodized
DSB-CLIA	DSB - 36", Illuminated, Clear Anodized, Anti-Microbial
DSB-CLIA42	DSB - 42", Illuminated, Clear Anodized, Anti-Microbial
DSB-CLIA48	DSB - 48", Illuminated, Clear Anodized, Anti-Microbial
DSB-TDM	Through Door Mounting Kit for DSB
EL-DSB-CL	Dual Sense Bar - 36", Clear Anodized, ElectroLynx
EL-DSB-CLA	Dual Sense Bar - 36", Clear, ElectroLynx, Anti-Microbial
TCP-BK	Touch Bar Cover Plates - Set of 2, Black Anodized
TCP-CL	Touch Bar Cover Plates - Set of 2, Clear Anodized





PRODUCT FEATURES

- Can be field cut to accommodate non-standard openings up to 48"
- Activates a DPST 2 Amp rated relay when touched (no mechanical movement) which will allow free egress, or initiates the delay on an exit delay timer
- Backup push button
- 16 ft. [4.8m] 22AWG 6 conductor cable and armored door cord included
- Automatic dual voltage 12VDC/24VDC
- Available ElectroLynx® ready
- MagnaCare Lifetime Replacement No Fault Warranty

PRODUCT OPTIONS

- 36" Length
- 42" Length
- 48" Length
- EL- Prefix any model for ElectroLynx® ready
- D- Prefix any model for dummy bar with no release function

- Through-bolt kit works on doors up to 2-1/4" thick
- Cover plates for retrofit of competitor products
- Trailing edge timer

SPECIFICATIONS

- ANSI/UL 294 Listed
- CSA-C22.2 No.205 Listed
- CSFM – California State Fire Marshal Approved
- MEA- City of New York Approved
- CE: EN 50091-1, EN 61000-6-2 Approved

Electrical:
40mA at rest; 25mA releasing at 12VDC or 24VDC

Operating Temperature:
+32 to +110F [0 to +43C]
Recommended for indoor use

Shipping Weight:
7lbs [3.18kg] to 9lbs [4.08kg]
depending on length

Finishes:
BK - Black anodized
CL - Clear anodized

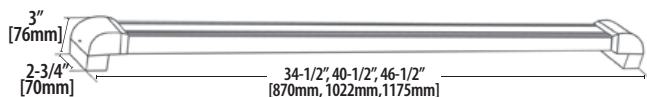

TCP covers unwanted mounting holes from previously installed exit bars



TSB

Touch Sense Bar

Touch-Triggered Release for Reliable Egress

The TSB Touch Sense Bar provides touch-triggered release of magnetically locked, non-fire-rated doors. Touching the bar, even through light gloves or clothing, triggers an electronic sensor that releases the lock. For indoor use only, the TSB installs easily on all types of metal, aluminum or wood frame doors. Meets "no special tools or knowledge" criteria in code requirements.

» MODELS

PART # | Description

TSB-BK	TSB - 36", Black Anodized
TSB-BK-42	TSB - 42", Black Anodized
TSB-BK-48	TSB - 48", Black Anodized
TSB-BKT	TSB - 36" w/ Trailing Edge Timer [3 sec], Black Anodized
TSB-BKT-48	TSB - 48" w/ Trailing Edge Timer [3 sec], Black Anodized
TSB-CL	TSB - 36", Clear Anodized
TSB-CL-42	TSB - 42", Clear Anodized
TSB-CL-48	TSB - 48", Clear Anodized
TSB-CLT	TSB - 36" w/ Trailing Edge Timer [3 sec], Clear Anodized
TSB-CLT-42	TSB - 42" w/ Trailing Edge Timer [3 sec], - Clear Anodized
DTSB-BK	Dummy TSB Bar - 36" w/ End Caps & Fasteners, Black Anodized
DTSB-BK-42	Dummy TSB Bar - 42" w/ End Caps & Fasteners, Black Anodized
DTSB-BK-48	Dummy TSB Bar - 48" w/ End Caps & Fasteners, Black Anodized
DTSB-CL	Dummy TSB Bar - 36" w/ End Caps & Fasteners, Clear Anodized
DTSB-CL-42	Dummy TSB Bar - 42" w/ End Caps & Fasteners, Clear Anodized
DTSB-CL-48	Dummy TSB Bar - 48" w/ End Caps & Fasteners, Clear Anodized
EL-TSB-BK	TSB - 36", Black Anodized, ElectroLynx
EL-TSB-BK-42	TSB - 42", Black Anodized, ElectroLynx
EL-TSB-BK-48	TSB - 48", Black Anodized, ElectroLynx
EL-TSB-CL	TSB - 36", Clear Anodized, ElectroLynx
EL-TSB-CL-42	TSB - 42", Clear Anodized, ElectroLynx
EL-TSB-CL-48	TSB - 48", Clear Anodized, ElectroLynx
TCP-BK	Touch Bar Cover Plates - Set of 2, Black Anodized
TCP-CL	Touch Bar Cover Plates - Set of 2, Clear Anodized
TSB-TDM	Through Door Mounting Kit for TSB-3



DUAL VOLTAGE

SECURITRON
ASSA ABLOY



TSH

Touch Sense Handle

Compact Push or Pull Egress Alternative for Maglock Release

Sized to conceal existing mounting holes, the TSH Touch Sense Handle replaces standard pulls on aluminum doors to allow maglock release for egress. With flexible options, it works equally well on inswing doors or as a push-open device for outswing doors, offering a clean look on aluminum frame glass doors.

PRODUCT FEATURES

- For use on any push, pull or swing-through door
- Activates electronic release via DPST 2 Amp rated relay when touched to allow free egress
- Backup push button
- 16 ft. [4.8m] 22AWG 6 conductor cable and armored door cord included
- Automatic dual voltage 12VDC/24VDC
- MagnaCare Lifetime Replacement No Fault Warranty

PRODUCT OPTIONS

- EL- Prefix any model for ElectroLynx® ready
- D- Prefix any model for dummy bar with no release function

SPECIFICATIONS

- ANSI/UL 294 Listed
- CSA-C22.2 No.205 Listed
- CSFM – California State Fire Marshal Approved
- MEA- City of New York Approved
- CE: EN 50091-1, EN 61000-6-2 Approved

Dimensions:

5"L x 2-1/8"D x 9"H

Electrical:

40mA at rest; 25mA releasing at 12VDC or 24VDC

Operating Temperature:

+32 to +110F [0 to +43C]
Indoor use only

Shipping Weight:

3lbs [1.36kg]

Finishes:

BK - Black anodized

CL - Clear anodized

» MODELS

PART #	Description
TSH-BK	TSH - Push/Pull, Black Anodized
TSH-CL	TSH - Push/Pull, Clear Anodized
DTSH-BK	Dummy TSH Handle - Black Anodized
DTSH-CL	Dummy TSH Handle - Clear Anodized
EL-TSH-BK	TSH - Push/Pull, Black Anodized, ElectroLynx
EL-TSH-CL	TSH - Push/Pull, Clear Anodized, ElectroLynx

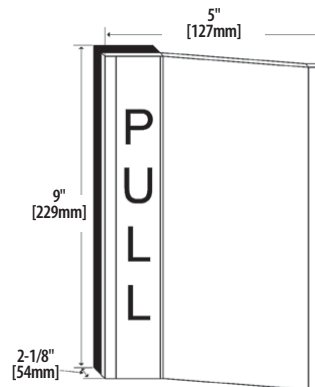



PRODUCT FEATURES

- DPST 2 Amp rated relay
- Internal 0-25 second timer
- Built-in redundant button
- MagnaCare Lifetime Replacement No Fault Warranty

Dimensions:

3-3/16" L x 1-1/2" D x 5-3/4" H

Electrical:

40mA at rest; 25mA releasing at 12VDC or 24VDC

Operating Temperature:

+32 to +110F [0 to +43C]
Indoor use only

Shipping Weight:

1.5lbs [0.68kg]

Finish:

US32D/630 - Satin Stainless Steel



SP-1

Touch Sense Plate

Touch Sense Technology in a Wall-Mount Request to Exit Plate

The SP-1 uses touch sensing technology to create a push plate with no moving parts. For indoor use only, the unit is oversized to cover a single gang cutout. Ideal to assist with ADA compliance, the unit includes a three-part vinyl "Touch to Exit" decal. A red LED is incorporated into the backbox.

» MODELS

PART #	Description
SP-1	Touch Sensor Plate
SP-1L	Label Touch Plate [SP-1]
SP-1LH	Label Touch Plate [SP-1] - Handicap Decal

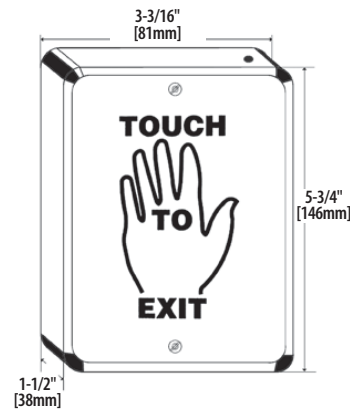

SECURITRON
ASSA ABLOY



PRODUCT FEATURES

- Low profile design requires only 1/4" movement for activation
- Three standard lengths: 36", 42" or 48"
- Can be field cut to accommodate non-standard openings up to 48"
- Uses same mounting pattern as the TSB and DSB
- Direct retrofit for some competitor footprints
- Mechanical action activates a DPDT 5 Amp rated output to allow free egress or initiate an exit delay timer
- Redundant switches ensure reliable, fault-tolerant operation
- All metal construction
- 16 ft. [4.8m] 22AWG 6 conductor cable and armored door cord included
- MagnaCare Lifetime Replacement No Fault Warranty

PRODUCT OPTIONS

- 36" Length
- 42" Length
- 48" Length
- **W-** Prefix on any model for weather-resistant upgrade
- Through-bolt kit works on doors 1-3/4" to 2-1/4" thick
- Cover plates for retrofit of competitor products

SPECIFICATIONS

- ANSI/UL 294 Listed
- Operating Temperature:**
-4 to +185F [-20 to +85C]
- Shipping Weight:**
7lbs [3.18kg] to 9 lbs [4.08kg] depending on length
- Finishes:**
BK - Black anodized
CL - Clear anodized



EMB

Electromechanical Bar

Mechanical Motion for Maglock Release in a Reliable, Durable Exit Bar

Use the Electromechanical Exit Bar (EMB) on magnetically locked, non-fire-rated doors or as an initiate device for a delayed egress timer. Pressing the bar activates internal mechanical switches that release the lock. Optional waterproof switches are available, which allow the EMB to function in protected outdoor applications. Meets "no special tools or knowledge" criteria for code requirements.

» MODELS	PART # Description
EMB-BK	EMB - 36", Black Anodized
EMB-BK-42	EMB - 42", Black Anodized
EMB-BK-48	EMB - 48", Black Anodized
EMB-CL	EMB - 36", Clear Anodized
EMB-CL-42	EMB - 42", Clear Anodized
EMB-CL-48	EMB - 48", Clear Anodized
WEMB-BK	EMB - 36", Black Anodized, Weatherproof
WEMB-BK-42	EMB - 42", Black Anodized, Weatherproof
WEMB-BK-48	EMB - 48", Black Anodized, Weatherproof
WEMB-CL	EMB - 36", Clear Anodized, Weatherproof
WEMB-CL-42	EMB - 42", Clear Anodized, Weatherproof
WEMB-CL-48	EMB - 48", Clear Anodized, Weatherproof
TCP-BK	Touch Bar Cover Plates - Set of 2, Black Anodized
TCP-CL	Touch Bar Cover Plates - Set of 2, Clear Anodized
EMB-TDM	Through Door Mounting Kit for EMB Series Bars



TCP covers unwanted holes from previously installed exit bars, strengthens the mounting area and provides a clean look.





PRODUCT FEATURES

- Activates a DPDT 2 Amp rated output when pushed or pulled, to allow free egress or initiate an exit delay timer
- 16 ft. [4.8m] 22AWG 3 conductor cable and armored door cord included
- MagnaCare Lifetime Replacement No Fault Warranty

PRODUCT OPTIONS

- Available ElectroLynx® ready

Dimensions:

5" L x 2-1/8" D x 9" H

Shipping Weight:

1.5lbs [0.68kg]

Finishes:

BK - Black anodized

CL - Clear anodized

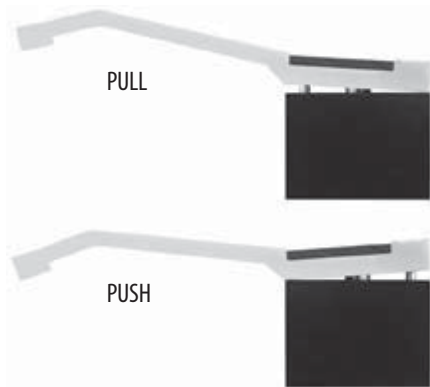

EMH Movement

EMH

Electromechanical Handle

Mechanical Motion for Mag Release in a Compact Handle

The EMH ElectroMechanical Handle works on any push, pull or swing-through door, and is designed for specialized outdoor applications. Pressing the Handle activates internal mechanical switches that release the lock. Meets "no special tools or knowledge" criteria for code requirements.

» MODELS

PART # | Description

EMH-BK Touch Handle - Electromechanical, Black Anodized

EMH-CL Touch Handle - Electromechanical, Clear Anodized

EL-EMH-BK EMH - Black Anodized, ElectroLynx

EL-EMH-CL EMT - Clear, ElectroLynx

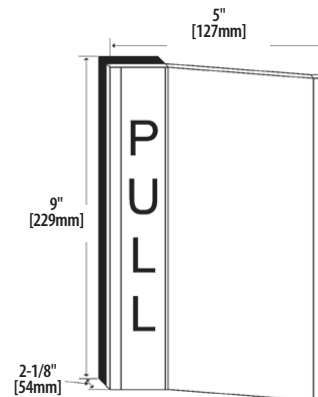

SECURITRON

ASSA ABLOY

Push Button Selector Chart

	Waterproof	Single Gang	Narrow Style	Surface	Green Button	Red Button	Blue Button	Steel Button	Illuminated	Momentary	Alternate	DPST	DPDT	SPDT	LED Color	Required Box Clearance
PB	X	X			X	X			X	X		X			R	1-3/4"
PBA	X	X			X	X			X		X	X			R	1-3/4"
PB2		X			X	X	X		X	X				X	R	2"
PB22		X			X	X	X		X	X			X		R	2"
PB2E		X			X	X	X			X				X		2"
PB3		X			X	X			X	X		X	*		R	1-1/2"
PB3A		X			X	X			X		X	X	*		R	1-1/2"
PB3AN			X		X	X			X		X	X	*		R	1-1/2"
PB3E		X			X	X				X		X	*			1-3/8"
PB3ER				X	X	X				X		X	*			SURFACE MOUNT
PB3EAR				X	X	X					X	X	*			SURFACE MOUNT
PB3EA		X			X	X					X	X	*			1-3/8"
PB3EAN			X		X	X					X	X	*			1-3/8"
PB3EN			X		X	X				X		X	*			1-3/8"
PB3N			X		X	X			X	X		X	*		R	1-3/8"
PB4L-2		X						X	X	X			X		BI-C	1-3/4"
PB4LA-2		X						X	X		X		X		BI-C	1-3/4"
PB4LN-2			X					X	X	X			X		BI-C	1-3/4"
PB4LAN-2			X					X	X		X		X		BI-C	1-3/4"
PB5		X			X	X	X		X	X		X	*			2"
PB5E		X			X	X	X			X		X	*			2"
EEB2		X			X	X	X									2"
EEB3N			X		X	X										1-1/2"

*All PB3 and PB5 Series can be field converted from DPST to DPDT. PB4 Series feature bi-colored LEDs.

Push Button Accessories



WCC



WBB

WCC and WBB weatherize any single gang Push Button to permit mounting in outdoor locations not directly exposed to rain or snow



PB2-LK



PB3-LK

PB2-LK - Illumination kit for PB2E, PB5E & EEB2
PB3-LK - Illumination kit for PB3E, PB3EN & EEB3N Series





PB SERIES » MEDIUM ROUND ILLUMINATED

- 7 Amp rated contacts
- Includes interchangeable green and red lenses
- Red LED on plate
- Stainless Steel single gang plate: 4-1/2" x 2-3/4" [114mm x 70mm]
- UL outdoor rated
- MagnaCare Lifetime Replacement No Fault Warranty

» MODELS

PART # | Description

PB	PB - Momentary, SG, DPST, Illuminated w/ Red/Grn Lens
PBA	PB - Alternate, SG, DPST, Illuminated w/ Red/Grn Lens



PB2 SERIES » LARGE SQUARE

- Easy to read 2" size
- 5 Amp rated contacts
- Includes interchangeable green, red and blue ADA lenses
- Stainless steel single gang plate: 4-1/2" x 2-3/4" [114mm x 70mm]
- MagnaCare Lifetime Replacement No Fault Warranty

Product Options

- Standard or Illuminated
- Single Pole-Double Throw
- Double Pole-Double Throw
- Red LED on plate

» MODELS

PART # | Description

PB2	PB - Momentary, Single Gang, Illuminated, Grn/Red/Handicap
PB22	PB - 2", Sq Grn Mom, DP w/Light - SG, Green/Red/Handicap
PB2E	PB - Momentary, Single Gang, Green/Red/Handicap
PB2-LK	Illumination Kit for PB2E, PB5E, EEB2 Series Push Buttons

PB

Push Buttons

Securitron® Quality with a Wide Range of Options for Size, Color and Function

High-quality Securitron Push Buttons are available in a broad selection of colors, sizes, switch types and outputs. With a wide range of options for interchangeable lenses and field convertible outputs, Securitron push buttons can release any maglock, alone or in conjunction with door closers and other hardware.



PB3

PB3E

PB3EN

PB3N

PB3 SERIES » ASSORTED SIZES AND COLORS WITH A UNIFORM LOOK

- 3 Amp rated contacts
- Includes interchangeable green and red lenses
- Field convertible from DPST to DPDT
- Stainless steel single gang plate: 4-1/2" x 2-3/4" [114mm x 70mm]
- Stainless steel narrow stile plate: 4-1/2" x 1-3/4" [114mm x 44mm]
- Surface mount: 3-7/8" x 2" [98mm x 51mm]
- Red LED on plate
- MagnaCare Lifetime Replacement No Fault Warranty

» MODELS

PART # | Description

PB3	PB - Momentary, Single Gang, Illuminated, Green/Red Lens
PB3A	PB - Alternate, Single Gang, Grn/Red Lens
PB3AN	PB - Alternate, Narrow, Grn/Red Lens
PB3E	PB - Momentary, Single Gang, Grn/Red Lens
PB3EA	PB - Alternate, Single Gang, Grn/Red Lens
PB3EAN	PB - Alternate Narrow, Grn/Red Lens
PB3EAR	PB - Remote Alternate, Surface Mount Green/Red Lens
PB3EN	PB - Momentary, Narrow Grn/Red Lens
PB3ER	PB - Remote Momentary, Surface Mount Grn/Red Lens
PB3-LK	Illumination Kit, Grn/Red for PB3E/EEB3N Series
PB3N	PB - Momentary Narrow, Green/Red Lens

SECURITRON®
ASSA ABLOY

PB

Push Buttons Continued



PB4L SERIES » VANDAL-RESISTANT STAINLESS BUTTON WITH ILLUMINATED HALO

- 4 Amp rated contacts
- Illuminated green Halo-style button
- Bi-color LED
- Vandal and tamper resistant
- Stainless steel single gang plate: 4-1/2" x 2-3/4" [114mm x 70mm]
- Stainless steel narrow stile plate: 4-1/2" x 1-3/4" [114mm x 44mm]
- MagnaCare Lifetime Replacement No Fault Warranty

» MODELS

PART # | Description

PB4L-2	PB [DP], Momentary, Single Gang, Green Illuminated Halo
PB4LA-2	PB [DP], Alternate, Single Gang, Green Illuminated Halo
PB4LAN-2	PB [DP], Alternate, Narrow Stile, Green Illuminated Halo
PB4LN-2	PB [DP], Momentary, Narrow Stile, Green Illuminated Halo



PB5 SERIES » EASY TO READ LARGE ROUND

- 5 Amp rated contacts
- Includes interchangeable green, red and blue ADA lenses
- Stainless Steel single gang plate: 4-1/2" x 2-3/4" [114mm x 70mm]
- Field convertible from DPST to DPDT
- MagnaCare Lifetime Replacement No Fault Warranty

» MODELS

PART # | Description

PB5	PB - 2" Round, Momentary, DPST, w/Light, SG, Red/Grn/Handicap
PB5E	PB - 2" Round, Momentary, DPST, w/o Light, SG, Red/Grn/Handicap
PB2-LK	Illumination Kit for PB2E, PB5E, EEB2 Series Push Buttons

MAGNACARE® LIFETIME REPLACEMENT WARRANTY

The Industry's Best Warranty

LIFETIME - NO FAULT - TOMORROW

- MagnaCare covers every product that Securitron® manufactures. No product registration is required.
- Your product will be replaced FOREVER, for any reason, including but not limited to installation error, vandalism or act of God.
- Replacement product is shipped next day air at Securitron's expense if needed.

At Securitron®, we pay special attention to the needs of our customers. Our 1-800-MAGLOCK sales and service support line puts you in touch with our knowledgeable and friendly team to assist you with the smallest detail, or the most difficult application, including wiring diagrams. In 1999, Securitron introduced the first "no strings attached" warranty program called MagnaCare. MagnaCare replaces any product that we manufacturer, for any failure reason, for the life of the installation.

*Vista Series maglocks are covered by VistaCare One Year No Fault Warranty.
BPSS and R100-1H are protected by SecuriCare Three Year No Fault Warranty.*

SECURITRON®
ASSA ABLOY



PRODUCT FEATURES

- Backup device in case of exit sensor failure per BOCA, NFPA, NBC, and VBC code
- SPST 3 Amp wet N/C contacts
- Momentarily pressing the EEB releases the door for 30-seconds
- Re-triggerable for added 30-second release
- Field-selectable 12VDC or 24VDC to match lock voltage
- Interchangeable green and red lenses included standard
- MagnaCare Lifetime Replacement No Fault Warranty

PRODUCT OPTIONS

- Single gang
- Narrow stile
- EEB2 includes standard lenses plus blue ADA lens
- Illumination kits

SPECIFICATIONS:

- (EEB2, EEB3N only)
- ANSI/UL 294 Listed
 - CSA-C22.2 No.205 Listed
 - CSFM – California State Fire Marshal



EEB

Exit Buttons

Redundant Backup Ensures Safe Egress

Install the EEB Emergency Exit Button next to the door to provide additional safety and redundancy as required by code when using a motion detector for a request-to-exit device.

» MODELS

PART # | Description

EEB2	EEB w/ 30 Sec. Timer - SG, Grn/Red/Handicap
EEB3N	EEB w/ 30 Sec. Timer - Narrow Stile, Grn/Red
PB2-LK	Illumination Kit for PB2E, PB5E, EEB2 Series Push Buttons
PB3-LK	Illumination Kit, Grn/Red for PB3E/EEB3N Series

Note: Securiton's UL294 certification indicates that when the EEB is used with the XMS Motion Sensor, it meets the NFPA Life Safety Code 101 requirements for exit of access-controlled egress doors.



DUAL VOLTAGE

SECURITRON
ASSA ABLOY

XMS

Exit Motion Sensor

Versatile Motion Detection for Hands-Free Exit Request

The XMS Passive Infrared motion sensor reliably detects motion near a door and releases its magnetic lock. Versatile mounting options and an easily adjustable infrared beam pattern provide optimal coverage of the egress area for smooth, hands-free lock release and exit.



PRODUCT FEATURES

- Passive Infrared Request to Exit Device
- Automatically and reliably cuts power to the lock with no human intervention
- Request to exit (REX) output
- Easily adjustable beam pattern
- Adjustable time relock
- MagnaCare Lifetime Replacement No Fault Warranty

SPECIFICATIONS

- ANSI/UL 294 Listed
- Dimensions:**
7" L x 1-7/8" W x 1-3/4" H
Indoor use only
- Electrical:**
20mA-50mA (depending on switching status) at 12VDC or 24VDC
- Shipping Weight:**
0.5lbs [0.23kg]

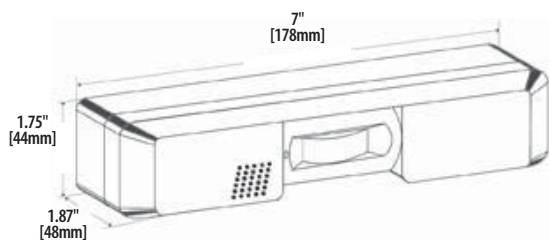

» MODELS

PART # | Description

XMS | Exit Motion Sensor

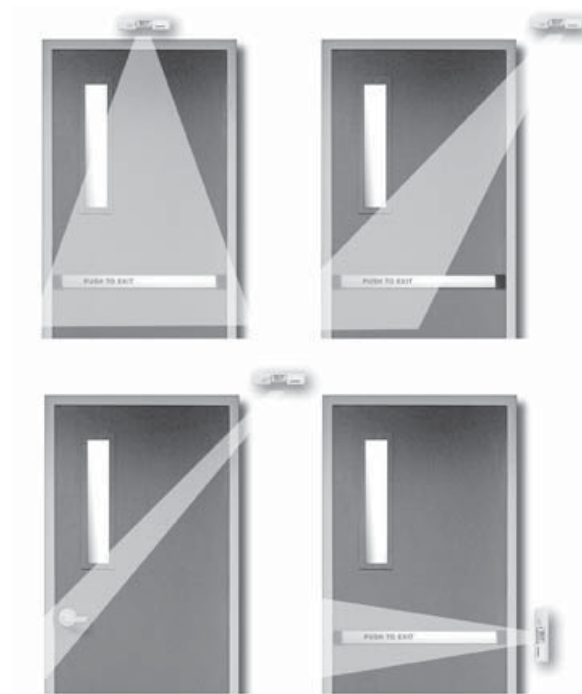

Safety Note: Securtron recommends that an emergency exit button, such as the EEB, be used in conjunction with the XMS to meet applicable building codes and specific life safety issues.



SECURITRON
ASSA ABLOY



PRODUCT FEATURES

- Active microwave motion sensing using Doppler radar—more reliable than infrared sensors
- Adjustable sensing zone from 4" to 24" helps screen out incidental traffic
- Microwave sensing FCC certified for use in general and medical environments
- Touchless activation for hands-free operation, reduces transmission of germs
- Pulse mode to initiate action or toggle mode to provide on/off switch
- Offered in a single-gang or double-gang model
- Mounting ring included or install in standard plastic or metal gang box
- Water resistant—foam gasket included
- Compatible with Securiton WBB Weather Back Box and WCC Weather Cover-Clear
- MagnaCare Lifetime Replacement No Fault Warranty

SPECIFICATIONS

- Electromagnetic compatibility according to 2004/108/EC
- FCC: G9B-MS08
- IC: 4680A-MS08

Dimensions:

Single gang faceplate:

4-1/2" x 2-3/4"

Double gang faceplate:

4-1/2" x 4-1/2"

Current:

Self-sensing 12 or 24V DC or AC input ($\pm 10\%$)

Maximum power consumption: less than 1.5 Watts

1 amp SPDT contact can be operated in toggle or pulse mode

Pulse output: 0.5 seconds

Operating Temperature:

-4 to +131F [-20 to +55C]

Shipping Weight:

0.5 lbs

Need an Outdoor Solution?

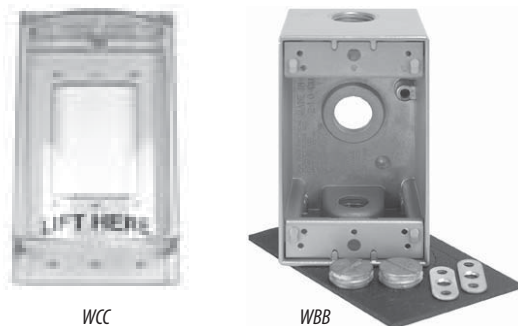

WCC and WBB allow the Wave Sense Switch to be mounted in outdoor locations not directly exposed to rain or snow

WSS

Wave Sense® Switch

No-Touch Switch for Hands-Free Activation

The Wave Sense Switch features a new class of motion sensing technology for hands-free, contactless switch activation. Use for request to exit (REX), activation or on/off switching to trigger a variety of access control devices in place of a push plate or push button.

» MODELS

PART # | Description

WSS-W1	Wave Sense Switch—with white, single gang faceplate
WSS-W2	Wave Sense Switch—with white, double gang faceplate
WBB	Weather Back Box
WCC	Weather Cover-Clear



DUAL VOLTAGE

SECURITRON
ASSA ABLOY



PRODUCT FEATURES

- Fully-encrypted AES 128 wireless communication
- Online transaction audit trail capability
- Low battery signaling and reporting
- Suitable for outdoor use
- Up to 40,000 cycles per battery
- Green status LED indicator
- Two models are available to support low frequency or high frequency cards
- › Low frequency model supports PROX and EM PROX
- › High frequency model supports iCLASS, iCLASS Seos™, iCLASS SE, ISO14443B UID, Mifare, Mifare Plus, Desfire SE, Desfire EV1, NFC
- Protected by SecuriCare 3-Year, No Fault Warranty

PRODUCT SPECIFICATIONS

- Dimensions:**
4.25" x 1.8" x 1.0"
[108mm x 46mm x 26mm]
- Operating Temperature:**
-40 to +122F [-40 to +50C]
- Compliant:**
FCC, CE and IC Compliant
- Shipping Weight:**
2.83oz [80g]
- Battery:**
1 x 3V CR2 Lithium Battery

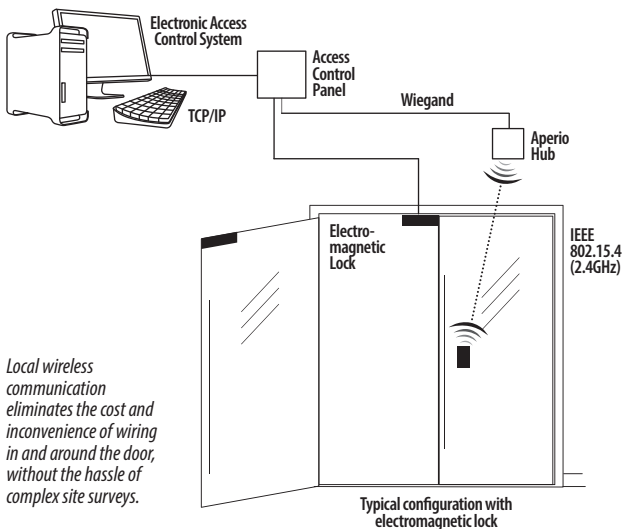

R100-1H

Wireless Reader and Apero® Hub

Surface Mounted—No Drilling

The R100-1H surface mounted wireless reader and pre-prepared Apero hub offers an elegant way to extend access control to glass, stone, granite or marble entryways. Installation is easy, requires no drilling or pulling of wires and can adhere in minutes. A complement to an electronic locking solution, glass entryways can now integrate robust access control while maintaining a clean, wireless appearance.

MODELS

	PART #	Description
R100-1H-SE		R100, iCLASS SE, Wholesale Kit with 1:1 Hub
R100-1H-PA		R100, PROX, Wholesale Kit with 1:1 Hub
R100-DCA		R100 Dress Cover, Aluminum

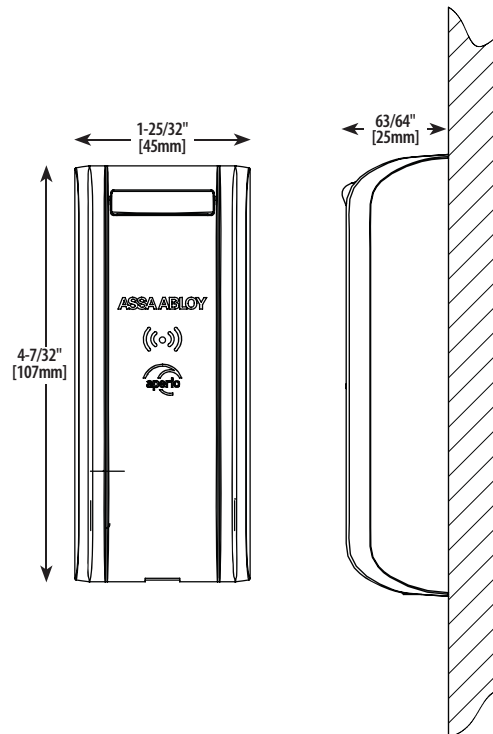



PRODUCT FEATURES

- Single gang, stainless steel plate with low voltage mounting ring
- 12 key illuminated 3x4 keypad
- True 10-digit operation (10 digits plus * and # keys)
- 99 user code capability
- Easy programming from the keypad
- Passage mode and Lockout mode
- Configurable audible keystroke echo
- Red, green and yellow LEDs for status and programming feedback
- Fail secure or fail safe-capable
- Easy to install with simple hand tools
- Accepts 12V or 24VAC or DC current
- 5 Amp SPDT timed, control relay output
- Request to Exit (REX) input
- MagnaCare Lifetime Replacement No Fault Warranty

PRODUCT OPTIONS

- Weather-resistant cover
 - Weather-resistant backbox
- Dimensions:**
2-3/4"W x 4-1/2"H x 5/32"D
- Electrical:**
70mA at 12VDC or 24VDC
Maximum 30VDC or 300VAC switched voltage
- Operating Temperature:**
-10 to +140F [-23 to +60C]
Primarily for indoor applications
- Shipping Weight:**
1lb [0.45kg]
- Finishes:**
US32B/630 - Satin Stainless Steel

Need an Outdoor Solution?



WCC



WBB

WCC and WBB allow DK-12 keypad to be mounted in outdoor locations not directly exposed to rain or snow

DK-12

Digital Keypad

All-in-One Keypad System for Single-Door Traffic Control

The DK-12 standalone keypad and controller is ideal for lower security requirements such as traffic control. Easy to install and easy to program, the one-piece DK-12 supports 99 user codes, including Passage mode and Lockout mode.

» MODELS

PART # | Description

DK-12	Digital Keypad System w/ Illuminated Keys - Single Gang
WBB	Weather Back Box
WCC	Weather Cover - Clear

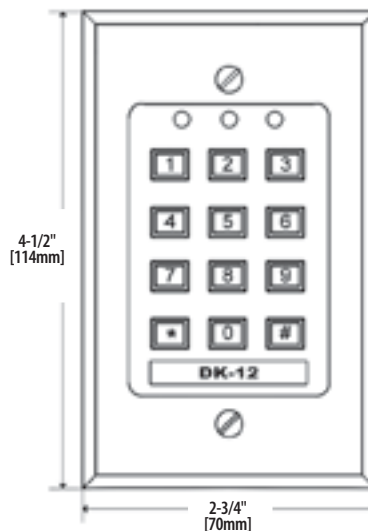



DK-16

Digital Keypad

Secure, Easy-to-Program Single Door Control System

The DK-16 digital keypad system provides medium/high security control of electric locks in a one- or two-door application where both doors have the same control needs. The tamper-resistant 3x4 keypad provides true 10-key operation for use and programming. Encased in a separate enclosure for secure installation in a protected area, the controller offers REX input and relay output for lock control, alarm shunt or other interfaces.

PRODUCT FEATURES

- 12 key 3x4 keypad with engraved and paint filled numbers
- Stainless steel plate
- Red, green and yellow LEDs for status and programming feedback
- Audible keystroke echo
- Controller mounted in plastic enclosure
- 59 users, expandable to 119
- User code and/or hard code disable feature
- 5 Amp DPDT relay output
- Request-to-exit (REX) input
- True 10 digit operation (keys are not paired), 3 LEDs and a beeper
- 16 ft. [4.8m], 12 conductor, 22 gauge keypad cable
- MagnaCare Lifetime Replacement No Fault Warranty

PRODUCT OPTIONS

- Wiegand output
- Expansion board to expand users to 119

- Weather-resistant cover
- Weather-resistant back box
- Keypad available as system or separately

Dimensions:

Keypad:
2-3/4"W x 4-1/2"H x 5/32"D

Enclosure:
6"W x 8"H x 3"D

Electrical:

7mA at rest; 160mA active at 12VAC or 12VDC
20mA at rest; 190mA active at 24VAC or 24VDC

Operating Temperature:

CPU:
+32 to +158F [0 to +70C]

Keypad:
+32 to +110F [0 to +43C]

Primarily for indoor use

Shipping Weight:

4.2lbs [1.91kg]

Finishes:

US32D/630 – Satin Stainless Steel

MODELS

PART #	Description
DK-16	Digital Keypad System - Indoor, Single Gang
DK-16P	Digital Keypad Pad - Indoor, Single Gang
DK-16W	Digital Keypad System - Wiegand, Indoor, Single Gang
DK-16XB	DK-16 w/ Expansion Board - Indoor, Single Gang
WBB	Weather Back Box
WCC	Weather Cover - Clear

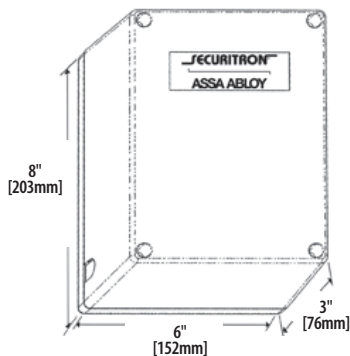
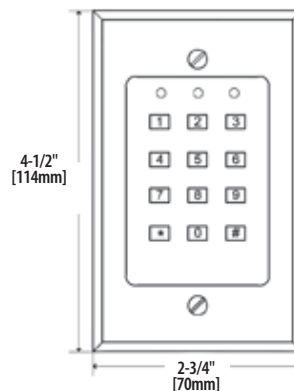



PRODUCT FEATURES

- Cast stainless steel with 11 EPDM rubber keys
- Weatherproof and vandal resistant
- 12V or 24V/ AC or DC current
- Mounts on a narrow mullion
- Audible keystroke echo
- True 10 digit operation (keys are not paired)
- 59 users with multiple entry codes
- Expansion board adds users, real time calendar, more relays and outputs
- User code and hard code disable feature
- Passage Mode and Lockout Mode
- 5 Amp DPDT relay
- Request-to-exit (REX) input
- 16 ft. [4.8m], 12 conductor, 22 gauge keypad cable
- 3 LEDs and a bell button
- MagnaCare Lifetime Replacement No Fault Warranty

PRODUCT OPTIONS

- "W" indicates Wiegand output
- Expansion board for up to 119 users
- Spy Shield
- Cover plate
- Keypad available as system or separately

SPECIFICATIONS

- CE: EN 50091-1, EN 61000-6-2 Approved

Dimensions:
Keypad: 1-1/2"W x 7"H x 7/8"D

Enclosure: 6"W x 8"H x 3"D

Electrical:
7mA at rest; 160mA active at 12VAC or 12VDC

20mA at rest; 190mA active at 24VAC or 24VDC

Operating Temperature:
CPU: +32 to +158F [0 to +70C]

Keypad: -22 to +158F [-30 to +70C]

Indoor or Outdoor use

Shipping Weight:
5lbs [2.27kg]

Finishes:
US32D/630 - Satin Stainless Steel

BK - Black

DK-26

Digital Keypad

Digital Control System for Narrow Stile Applications

The DK-26 digital keypad system provides medium/high security control of electric locks in one or two door applications where doors have the same control needs. The fully weatherproof, rugged stainless steel keypad can be mounted in most outdoor environments. Encased in a separate enclosure for secure installation, the full-featured, easy to program, DK-26 is ideal for narrow stile applications.

» MODELS

PART # | Description

DK-26BK	Digital Keypad System - Narrow Stile, Black Anodized
DK-26BKXB	DK-26 w/ Expansion Board - Narrow Stile, Black Anodized
DK-26PBK	Digital Keypad Pad - Narrow Stile, Black Anodized
DK-26PSS	Digital Keypad Pad - Narrow Stile, Stainless Steel
DK-26SS	Digital Keypad System - Narrow Stile, Satin Stainless
DK-26SSXB	Digital Keypad System - Narrow Stile w/ Expansion, Satin Stainless
DK-26WBK	Digital Keypad System - Wiegand, Narrow Stile, Black Anodized
DK-26WSS	Digital Keypad System - Wiegand, Narrow Stile, Satin Stainless

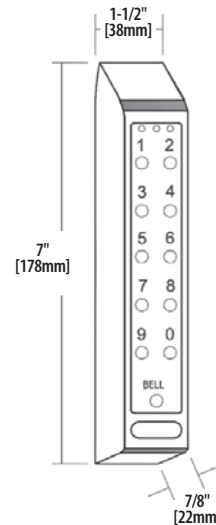

SECURITRON
ASSA ABLOY



PRODUCT FEATURES

- Supports any keypad or card reader capable of 26-bit Wiegand output
- Compatible with the ASSA ABLOY Aperio® family of wireless products
- Downloadable audit trail for time/date stamped user access
 - › Stores up to 2000 total events
- New, easy-to-use, intuitive remote programming option
 - › Enter codes from the comfort of the administrator's desk using the DKC Programming Tool for later upload to the controller
 - › Optional easy keypad programming at the keypad or the controller board
- Independently controls up to two doors
- Up to 250 users per door
- Non-volatile memory for fast recovery in power outages with no data loss

- User code and/or hard code disable feature
- 5 Amp SPDT relay output for lock control and alarm shunt, camera call-up, door prop, tamper detect, duress, doorbell or forced entry
- MagnaCare Lifetime Replacement No Fault Warranty

SPECIFICATIONS

- FCC Part 15 and Industry Canada Compliant
- Patents pending

Dimensions:

6"W x 8"H x 3"D

Electrical:

Dual voltage 12VDC or 24VDC; Minimum 1A supply for the base unit, add supply current for any devices connected to the DC outputs

Operating Temperature:

+32 to +158F [0 to +70C]

Shipping Weight:

1.75lbs [0.8kg]



DKC

Digital Controller

Stand-Alone 2-Door Controller for a Flexible, Secure System

The DKC Digital Controller provides stand-alone control of up to two electrically locked doors. Adding door users is fast and simple, either upload via easy-to-use software or program directly from an installed system keypad. The DKC offers broad flexibility and ease of use for access control professionals looking for a cost-effective solution for small, simple configurations.

A new, easy-to-use software Programming Tool with upload feature allows quick deployment of a two-door, stand-alone system with the flexibility to use any output reader or keypad capable of 26-bit Wiegand output. The DKC is also compatible with ASSA ABLOY Aperio® wireless products. It communicates with an Aperio Wiegand hub in place of an electronic access control system.

Choose from high quality Securitron options, wireless ASSA ABLOY Aperio products, or connect to HID® proximity or smart card readers for sophisticated yet simple access control.

» MODELS

PART# | Description

PART#	Description
DKC	Digital Keypad Controller – 2-Door Controller with Programming Tool

SECURITRON®
ASSA ABLOY

DK-37

Digital Keypad

Digital Keypad for Narrow Stile Applications

The DK-37 digital keypad offers Wiegand output for universal compatibility with access control systems. The fully weatherproof stainless steel keypad is designed for narrow stile applications.

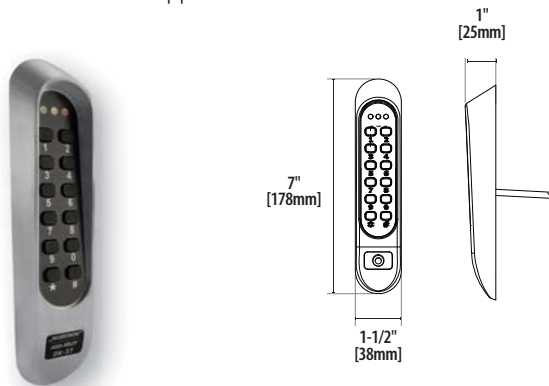

PRODUCT FEATURES

- 12-key cast stainless steel 2x6 keypad with silicone rubber keys
- Weatherproof and vandal resistant
- Dual voltage 12VDC or 24VDC
- Mounts on narrow mullion
- Compatible with access control systems using standard Wiegand output
- Red, green and yellow status LEDs
- Audible keystroke echo
- MagnaCare Lifetime Replacement No Fault Warranty

PRODUCT OPTIONS

- Spy Shield
- DKC Digital Controller

SPECIFICATIONS

- FCC Part 15 & Industry Canada Compliant
- Patents Pending

Dimensions:
1-1/2"W x 7"H x 1"D

Electrical:
35mA Active, 7mA at Rest at 12VDC
75mA Active, 16mA at Rest at 24VDC

Operating Temperature:
-22 to +158F [-30 to +70C]
Indoor or outdoor use

Endurance:
1,000,000 cycles

Shipping Weight:
1.75lbs [0.8kg]

Finishes:
US32D/630 - Satin Stainless Steel
BK - Black Powder Coat

» MODELS

PART # | Description

- | | |
|---------|---|
| DK-37SS | Digital Keypad - Wiegand, Narrow Stile, Satin Stainless |
| DK-37BK | Digital Keypad - Wiegand, Narrow Stile, Black |



DUAL VOLTAGE

DK-38

Digital Keypad

Digital Keypad for Indoor Applications

The DK-38 digital keypad offers Wiegand output for universal compatibility with access control systems or the Securitron DKC. The 3x4 illuminated keypad features a flush-mount stainless steel faceplate.

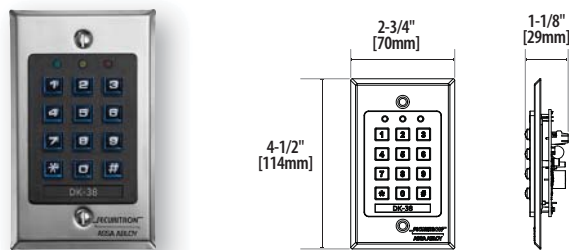

PRODUCT FEATURES

- 12-key illuminated 3x4 keypad
- Dual voltage 12VDC or 24VDC
- Compatible with access control systems using standard Wiegand output
- Single gang mounting
- Red, green and yellow status LEDs
- Tamper detection
- True 10-digit operation
- Audible keystroke echo
- MagnaCare Lifetime Replacement No Fault Warranty

PRODUCT OPTIONS

- DKC Digital Controller
- Weather-resistant cover
- Weather resistant back box

SPECIFICATIONS

- FCC Part 15 & Industry Canada Compliant

Dimensions:
2-3/4"W x 4-1/2"H x 1-1/8"D

Electrical:
52mA Active, 24mA at Rest at 12VDC
110mA Active, 50mA at Rest at 24VDC

Operating Temperature:
+32 to +110F [0 to +43C]
Indoor use

Endurance:
1,000,000 cycles

Shipping Weight:
1.5lbs [0.68kg]

Finish:
US32D/630 - Satin Stainless Steel

» MODELS

PART # | Description

- | | |
|-------|--|
| DK-38 | Digital Keypad - Wiegand, Single Gang, Satin Stainless |
|-------|--|



DUAL VOLTAGE





DK-S » SPY SHIELD

- Prevents viewing of the code being entered into the DK-26 or DK-37
- Available in stainless or black
- MagnaCare Lifetime Replacement No Fault Warranty

» MODELS

PART # | Description

DK-SBK	Digital Keypad - Spy Shield for Narrow Stile Keypads, Black
DK-SSS	Digital Keypad - Spy Shield for Narrow Stile Keypads, Satin Stainless



DK-WRI » WIEGAND OUTPUT

- Output Wiegand 2601 format data
- Interface with any access control system that accepts this data protocol
- Easily add keypad controlled entries
- Combine a keypad with a card reader
- DK-26/16 - external board is used
- May be purchased individually or together with the keypad
- MagnaCare Lifetime Replacement No Fault Warranty

» MODELS

PART # | Description

DK-WRI	Digital Keypad - Electronic, Wiegand Output
--------	---

ACCESSORIES

Digital Keypad



DK-XB » EXPANSION BOARD

- Real-time printer capability
- Provides an additional 60 user codes (for a total of 119 user codes, plus the programming code and a hard code)
- Serial printer output
- Additional programmable relay
- On-board, real-time clock and calendar for time/date reporting of access events
- Mounts inside DK-16, DK-26 CPU box
- MagnaCare Lifetime Replacement No Fault Warranty

» MODELS

PART # | Description

DK-XB	DK-16/26 Expansion Board Upgrade Kit w/Enclosure
-------	--

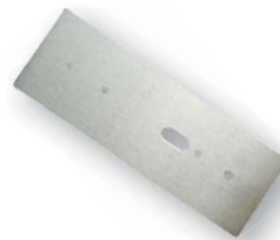

DK26-CPSS » COVER PLATE

- Allows DK-26 to be mounted over a single gang box
- MagnaCare Lifetime Replacement No Fault Warranty

» MODELS

PART # | Description

DK-CPSS	Digital Keypad Cover Plate - [3 x 8] Satin Stainless
---------	--



Keyswitch Selection Guide

	Single Gang	Narrow Stile	Double Gang	Lock #2 Keys	Momentary	Alternate	SPDT	DPDT	Bi-Colored LED	Add On
MK	X				X		X		X	
MK2	X				X			X	X	
MKA	X					X	X		X	
MKA2	X					X		X	X	
MKAN		X				X	X		X	
MKAN2		X				X		X	X	
MKN		X			X		X		X	
MKN2		X			X			X	X	
MKPZ			X		X		X		X	
MKAPZ			X			X	X		X	
MKS					X		X			X
MKS2					X			X		X
MKSA						X	X			X
MKSA2						X		X		X
MKC										X
MKC-KA										X
KP1	X			X	X		X		X	
KP1A	X			X		X	X		X	
KP1AN		X		X		X	X		X	
KP1N		X		X	X		X		X	

Single Pole - Single Throw (SPST)

Switches that have one input and one output (NO or NC) and turn on or off in response to the switch action

Single Pole - Double Throw (SPDT)

Switches with one input and two outputs. When the switch operation occurs, the connection shifts from output A to output B

Double Pole - Single Throw (DPST)

Two SPST switches that operate in tandem using one switch operation so that two outputs turn on or off simultaneously in reaction to the switch operation

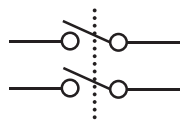

Double Pole - Double Throw (DPDT)

Two SPDT switches that operate in tandem using one switch operation so that each connection shifts simultaneously from its primary output to its secondary output

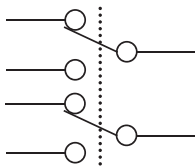

Momentary Switch

A momentary switch changes state during activation and reverts to its original state upon deactivation. A doorbell is a common example of a momentary switch. A timer can be used to extend the effect of the switch operation for a specific amount of time.

Double Pole - Single Throw (DPST)

An Alternate Switch changes state upon activation and does not change back until reactivated. A light switch is a common example of an alternate switch. Alternate switches are also called maintained or latching switches

Normally Open Contacts (NO)

A normally open contact provides an open circuit where no current is flowing in its usual state.

Wired in Parallel for Fail Secure type electric locks. i.e. Electric strike. Activating any switch will apply power releasing the lock.

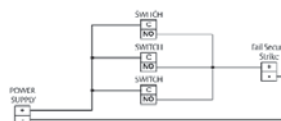

Normally Closed Contacts (NC)

A normally closed contact provides a closed circuit where current is flowing in its usual state.

Wired in Series for Fail Safe type electric locks. i.e. Securitron Maglocks. Activating any switch will break power releasing the lock.

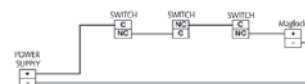

MK

Mortise Keyswitch

Turns Standard Mortise Cylinder into Full Featured Key Switch

The MK keyswitch supports electric lock control, alarm panel arming, reset and override when paired with any mortise cylinder 1-1/8" to 1-1/2".



PRODUCT FEATURES

- Standard with momentary SPDT switch
- 12 or 24VDC
- Bi-color LED
- Backing bracket permits integration with any 1-1/4" [32mm] or 1-1/8" [28mm] mortise cylinder (not included)
- Support for 1-1/2" cylinder using spacer ring and backset
- Additional switch position on backing bracket allows another switch to be activated by turning the key in the opposite direction
- 5 Amp rated plunger switch
- Includes anti-tamper screws
- MagnaCare Lifetime Replacement No Fault Warranty

PRODUCT OPTIONS

- Momentary or Alternate
- SPDT or DPDT
- Narrow Stile, Single- or Double-Gang
- Local annunciation via Piezo sounder
- Additional switch add on
- 1-1/8" Key Cylinder, 26D Finish, SC keyway

SPECIFICATIONS

- ANSI/UL 294
- CSFM - California State Fire Marshal Approved
- MEA - City of New York Approved

» MODELS

PART # | Description

MK	MK - Momentary, Single Gang
MK2	MK - DPDT Momentary, Single Gang
MKA	MK - Alternate, Single Gang
MKA2	MK - DPDT Alternate, Single Gang
MKAN	MK - Alternate - Narrow
MKAN2	MK - DPDT Alternate, Narrow
MKAPZ	MK w/ Audible - Alternate, Double Gang
MKC	Mortise Cylinder for MK Series
MKC-KA	Mortise Cylinder for MK Series - Keyed Alike
MKN	MK - Momentary, Narrow
MKN2	MK - DPDT Momentary, Narrow
MKPZ	MK w/ Audible Momentary - Double Gang
MKS	MK - Momentary, Switch Only
MKS2	MK - DPDT Momentary, Switch Only
MKSA	MK - Alternate, Switch Only
MKSA2	MK - DPDT Alternate, Switch Only

KP1

Tubular Keyswitch

Simple Solution for Exit, Door Release, Manual Override or Reset



PRODUCT FEATURES

- For less demanding applications
- Stainless steel face plates
- 12/24VDC bi-color LED, tubular style keyswitches
- 7 Amp rated SPDT switch
- Momentarily turning the key changes the state of the contacts

- Includes anti-tamper screws
- Includes two keys
- MagnaCare Lifetime Replacement No Fault Warranty

PRODUCT OPTIONS

- Momentary or Alternate switch
- Single gang or narrow stile

» MODELS

PART # | Description

KP1	Tubular Keyswitch Momentary - Single Gang
KP1A	Tubular Keyswitch Alternate - Single Gang
KP1AN	Tubular Keyswitch Alternate - Narrow
KP1N	Tubular Keyswitch Momentary - Narrow



SECURITRON
ASSA ABLOY

DPS

Door Position Switches

DPS-W and DPS-M door position switches enable access control systems to monitor the open or closed state of a door. These switches can transmit an initiate signal to Securitron's XDT delayed exit logic timers and DPA door prop logic timers.



DPS-W

Concealed Door Position Switch for Wood Doors

- Mated magnetic switch and cylindrical magnetic contact
- Recesses into door and frame
- 3/4" [19mm] round installation, 15/16" deep
- Provides Normally Closed SPST switch
- Works with door gap up to 3/4" [18mm]
- MagnaCare Lifetime Replacement No Fault Warranty

DPS-M

Concealed Door Position Switch for Metal Doors

- Mated magnetic switch and magnetic contact

- Recessed into door and frame
- 3/4" [19mm] round installation, 1/2" deep
- Larger cylindrical magnet counters shielding effect of steel
- Provides Normally Closed SPST switch
- Works with door gap up to 3/4" [18mm]
- MagnaCare Lifetime Replacement No Fault Warranty

PRODUCT OPTIONS

- Available in white, gray or black

Electrical:

Switching Current AC/DC (max): 0.4A

Operating Temperature:

-40 to +150F [-40 to +65C]

» MODELS

PART # | Description

DPS-M-BK	DPS for Metal Doors - Black
DPS-M-GY	DPS for Metal Doors - Grey
DPS-M-WH	DPS for Metal Doors - White
DPS-W-BK	DPS for Wood Doors - Black
DPS-W-GY	DPS for Wood Doors - Grey
DPS-W-WH	DPS for Wood Doors - White

J-1055-04F

Door Position Switch

Compact Concealed Door Position Switch for Wood Doors

This economical, versatile door position switch fits into smaller spaces. Its compact, concealed design is ideal for wood door installations.



PRODUCT FEATURES

- Mated magnetic switch and magnetic contact
- Recessed into door and frame
- 1/4" round installation, approximately 1-1/4" deep
- Provides Normally Closed SPST switch

- Can be field modified to provide Normally Open contact
- MagnaCare Lifetime Replacement No Fault Warranty

Electrical:

Switching Current AC/DC (max): 0.5A

Operating Temperature:

-40 to +150F [-40 to +65C]

» MODELS

PART # | Description

J-1055-04F	Door Position Switch
------------	----------------------

SECURITRON
ASSA ABLOY



PRODUCT FEATURES

- Interfaces to access control and alarm systems for remote indication of open/closed status
- Unique "mated" magnetic contact for preventing defeat attempts by foreign magnets
- Can be used to provide initiate signal to XDT delayed egress timer
- Hidden anti-tamper output (MSS-1 and MSS-1G)
- Layered protection for tamper detection and reporting
- SPDT Contact
- MagnaCare Lifetime Replacement No Fault Warranty

PRODUCT OPTIONS

- MSS-1 includes jacketed cable for hollow metal applications
- MSS-1G includes a 3-foot [936mm] stainless steel cable
- -RT added to any product enables remote testing to confirm function

SPECIFICATIONS

- UL 634 Listed
- ULC/ORD-C634 Listed
- Patent number: 5,668,533

Dimensions: Contact

3/4"H x 4-1/4"L x 3/4"D

Switch

1-1/2"H x 4-1/4"L x 3/4"D

Electrical:

Main Output: SPDT at max of 125mA at 24VDC; 250mA at 12VDC

Tamper Output: Closed when secure; open to alarm - 1 Amp max current

Operating Temperature:

-40 to +150F [-40 to +65C]

Shipping Weight:

1.5lbs [0.68 kg]

MSS

Maximum Security Switches

Maximum Security Switches for Door Position Detection

Tamper-resistant Maximum Security Switches (MSS) provide versatile door monitoring with armored cable options to detect the status of windows, doors, gates and more in higher security settings. With multiple options for different environments, MSS can be used with access control or alarm systems to provide peace of mind where status detection is a critical concern.

» MODELS

PART # | Description

MSS-1	Magnetic Switch - High Security
MSS-1C	Magnetic Switch - High Security, Concealed
MSS-1C-RT	Magnetic Switch - High Security, Surface Mnt, Concealed w/ Remote Test
MSS-1G	Magnetic Switch - High Security, Surface Mount
MSS-1-RT	Magnetic Switch - High Security w/ Remote Test

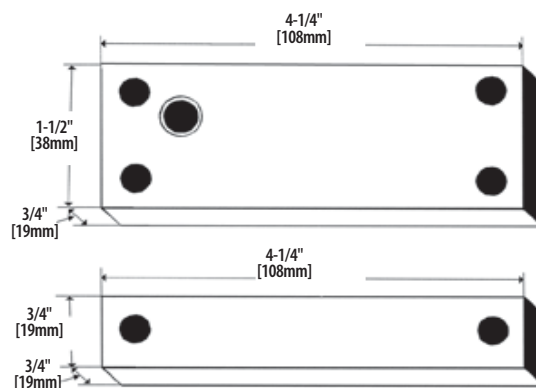

SECURITRON®
ASSA ABLOY

LM

Latch Monitors

The LM Series interfaces with an access control or alarm system to indicate the state of the latchbolt. Used alone or in conjunction with a door position switch, the LM provides confirmation that the door is secure, preventing false alarms and unauthorized access while providing tamper detection. Can also be used to transmit an initiate signal to model XDT delayed egress logic timers.

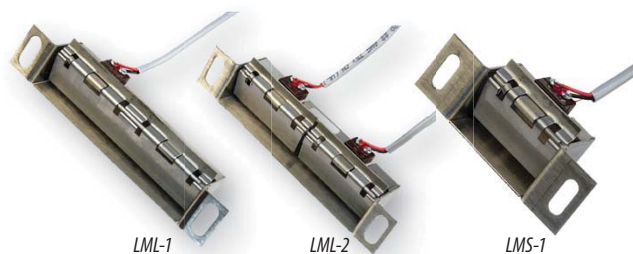

PRODUCT FEATURES

- Electronically detects and reports mechanical latch and bolt positions
- Provides peace of mind that the door is secure
- Installs easily, conceals behind existing hardware
- Requires no jamb or strike plate modification
- MagnaCare Lifetime Replacement No Fault Warranty

PRODUCT OPTIONS

- LML-1 provides SPDT switch, fits ANSI 4-7/8" cutout
- LMS-1 provides SPDT switch, fits ANSI 2-3/4" cutout

- LML-2 monitors mortise latch and deadbolt separately with two SPDT switches

SPECIFICATIONS

- UL 634 Listed
- ULC/ORD-C634 Listed
- ANSI/UL 294 Listed
- CSFM - California State Fire Marshal Approved
- Patent numbers: 5,757,269; 5,825,288

Electrical:
Contact Rating: SPDT 2 Amp at 24V

Operating Temperature:
-40 to +160F [-40 to +71C]

» MODELS

PART # | Description

LML-1	Latch Monitor for ANSI, 4-7/8, Strike, SPDT, 3Amp
LML-2	Latch Monitor for ANSI, 4-7/8, 2ea, SPDT, 3Amp
LMS-1	Latch Monitor for ANSI, 2-3/4, Strike, SPDT, 3Amp

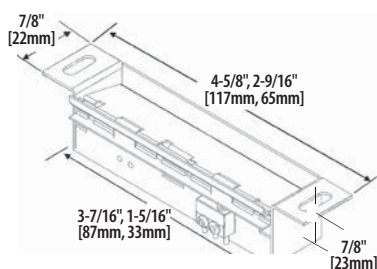

RPL

Relay Logic Pack

The economical, multi-function RPL logic circuit can be used as a DPDT latching alarm relay, or provide a relay for two-door interlocks (mantrap), or can initiate a brief signal delay to eliminate timing problems among multiple monitoring points on a door under access control.

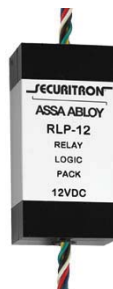

PRODUCT FEATURES

- Provides additional relay to access control systems requiring N/O or N/C dry status signals
- Provides a brief delay to harmonize door state reporting from multiple detection points
- Can create a relay interlock circuit
- Use with locks to create an interlocked trap entry

- Provides DPDT relay with 1 Amp contacts
- Provides time delay of door operator when electric lock is used
- MagnaCare Lifetime Replacement No Fault Warranty

Electrical Max Draw:
30mA at 12VDC or 15mA at 24VDC Max

Operating Temperature:
-13 to +158F [-25 to +70C]

» MODELS

PART # | Description

RPL-12	Relay Logic Pack - 12VDC
RPL-24	Relay Logic Pack - 24VDC

SECURITRON
ASSA ABLOY



RB Relay Board

The RB4 provides Normally - Open or Normally - Closed relays that can be interconnected. Ideal for interlock installations or wherever a basic relay board is used to trigger action, shunt alarms or report status from an access control system.

PRODUCT FEATURES

- 4 DPDT relays with 2 Amp contacts
- Individual coil connections - common negative or positive
- Replaces socket mount relays
- Dry contact connections via screw terminals
- Relays have low current coils (13mA at 12VDC; 8mA at 24VDC)

- Allows operation from most LED drive outputs
- MagnaCare Lifetime Replacement No Fault Warranty

Dimensions:
4"W x 3-1/2"H

Electrical Max Draw:
32mA at 12VDC or 32mA at 24VDC

Operating Temperature:
-13 to +158F [-25 to +70C]

MODELS

PART# | Description

- | | |
|----------------|---------------------|
| RB-4-12 | Relay Board - 12VDC |
| RB-4-24 | Relay Board - 24VDC |

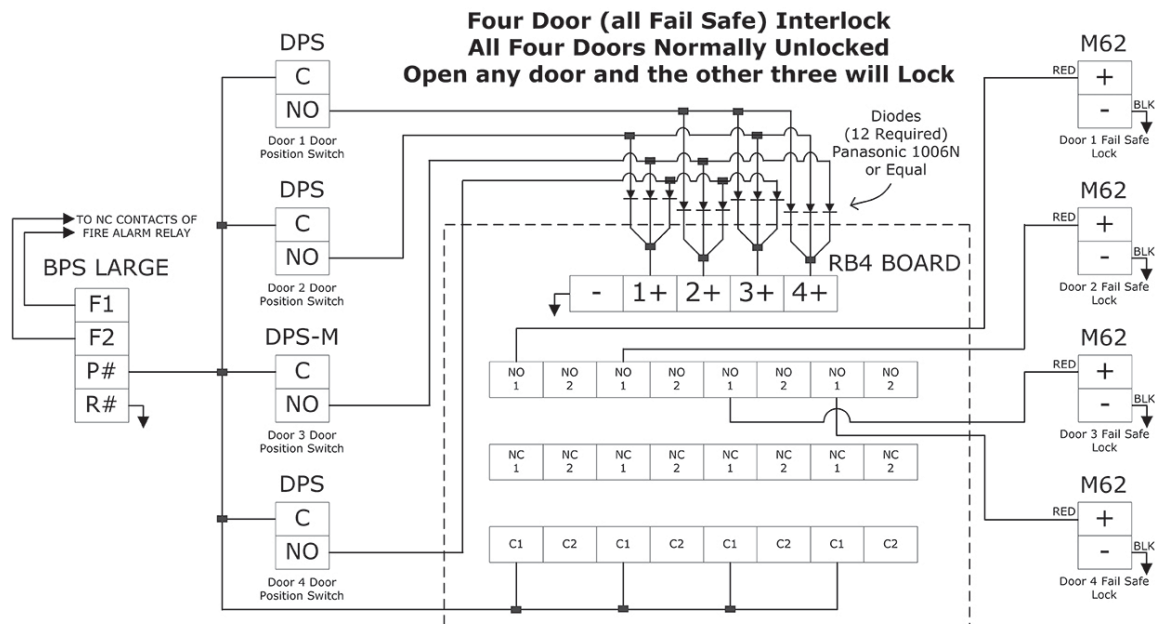

SECURITRON
ASSA ABLOY

TM-2

Time Master II Multi-Function Timer

The TM-2 is a premium, industrial duty, multi-function timer that provides precise timing using stackable increments in seconds or minutes and easy-to-use dip switch settings. Ideally suited for unusual time sequencing requests, like bank or ATM vaults.



PRODUCT FEATURES

- Industrial quality multi-function timer for delay or time sequencing
- DIP switches select delay times of 1 to 255 seconds or minutes
- Flashing LED provides visual indication of remaining time or alert status

- Triggering can be from an N/O or N/C switch
- MagnaCare Lifetime Replacement No Fault Warranty

Electrical:
12 or 24VAC or VDC with 5 Amp DPDT relay output

Operating Temperature:
+32 to +149F [0 to +65C]

» MODELS

PART #	Description
TM-2	Time Master II

TM-9

Time Mate Timer

The compact TM-9 extends the hold-open request of a pushbutton or keyswitch, enabling single-hand operation of the door or delaying re-arming of alarms.



PRODUCT FEATURES

- Miniature timer extends momentary switches
- Fits in outlet boxes with push buttons or keyswitches
- 3 Amp SPDT relay energizes for 2 to 36 seconds
- Time setting is selected by easy to configure DIP switches

- Applications include releasing electric locks and shunting alarm contacts
- MagnaCare Lifetime Replacement No Fault Warranty

Electrical:
12 or 24VDC or 24VAC

Operating Temperature:
+32 to +158F [0 to +70C]

» MODELS

PART #	Description
TM-9	Time Mate

PZ1

Piezo Sounder

The PZ-1 can be used as a local or remote alarm sounder for exit delay or door prop alarm.



PRODUCT FEATURES

- Remote annunciator
- Powerful Piezo sounder - 86 db
- Includes anti-tamper screws
- Stainless steel single gang plate 4-1/2" x 2-3/4" [114mm x 70mm]
- MagnaCare Lifetime Replacement No Fault Warranty

» MODELS

PART # | Description

PZ1 | Piezo on Keyplate - Single Gang

DT-7

Prime Time Digital Timer

Control doors equipped with electrified hardware - with or without access control - with The DT-7 digital timer. The DT-7 can be used as a stand-alone unit, or in conjunction with DK and other products. Versatile programming supports timed unlocked/locked/or access- control-only states to turn electric locks or other security systems on and off at programmed times.



PRODUCT FEATURES

- 7-day digital timer
- 10 Amp DPDT relay can be operated in toggle or pulse mode
- 12 programmed on/off times
- Set daily (6 on, 6 off), on selected days, or on blocks of days
- "First Man In" feature delays preset action until first access
- Supports holiday programming
- 12 or 24VAC or VDC
- AA battery provides backup to the display module program memory - battery not included
- MagnaCare Lifetime Replacement No Fault Warranty

Electrical:
170mA at 12V or 24V (VAC or VDC)

Operating Temperature:
+32 to +113F [0 to +45C]

Shipping Weight:
.75 lbs [0.34kg]

» MODELS

PART # | Description

DT-7 | Prime Time Digital Timer

SECURITRON
ASSA ABLOY

MAG LOCKS
ELECTROMECH
LOCKS
SPECIALTY LOCKS
EXIT DEVICES
ENTRY DEVICES
ACCESS CONTROL
ACCESSORIES
POWER SUPPLIES
POWER TRANSFER
ACCESSORIES
RESOURCES

DPA

Door Prop Alarm

The DPA complements door position/door state detection with timed logic and relays that provide escalating alerts when a door is held, propped or unsecure after a defined time period. This unit promotes safety and loss prevention at ancillary exits for healthcare, commercial and retail facilities, and dorms.



PRODUCT FEATURES

- Multi-functional control timer provides relay action for alarms and alerts
- Monitors whether a door remains open after a defined time frame
- Includes three 5 Amp SPDT outputs providing local and remote signaling
- Digital time settings from 30 to 240 seconds
- Detects attempts to tamper with lock or door status
- Multiple time ranges for escalating alerts
- Bypass mode for valid access/egress needs

- BA-DPA models come with Piezo sounder and LED
- MagnaCare Lifetime Replacement No Fault Warranty

Electrical:
Max draw 100mA at 12VDC
Max draw 50mA at 24VDC

Operating Temperature:
+32 to +120F [0 to +49C]

Shipping Weight:
DPA SERIES
DPA-24 0.5lbs [0.23kg]
DPA-12 0.5lbs [0.23kg]

BA-DPA SERIES
BA-DPA-24 2.05lbs [0.93kg]
BA-DPA-12 2.05lbs [0.93kg]

MODELS

PART #	Description
DPA-12	Door Prop Alarm Timer - 12VDC
DPA-24	Door Prop Alarm Timer - 24VDC
BA-DPA-12	Door Prop Alarm Timer - 12VDC w/ Boxed Alarm
BA-DPA-24	Door Prop Alarm Timer - 24VDC w/ Boxed Alarm



ACCESS CONTROL INNOVATIONS IPAD® APP

The Securitron® iPad app is available for free through the App Store. Search for "Securitron" and install the most recent version today.

The app provides on-the-go information for Adams Rite®, HES®, and Securitron in a convenient format with the latest updates on products. Get door opening solutions and lock systems specifications, images and catalog pages easily at your fingertips.

This reference guide is ideal for locksmiths, integrators, distributors, security specifiers and architects working in new construction or retrofit of commercial and industrial buildings.

FEATURES

- Search access control solutions for electric strikes, electromagnetic locks, entry and exit hardware, power supplies, aluminum storefront devices and more
- Product specifications and images
- Email individual catalog pages and sell sheets directly from the app to your customers
- View installation videos and product photos



The app is currently only available for iPads.