



SWIFT™
Smart Wireless Integrated Fire Technology
Instruction Manual

Document LS10036-000FL-E
4/10/2014

Rev: **A**

P/N LS10036-000FL-E:A

ECN 14-012

Fire Alarm & Emergency Communication System Limitations

While a life safety system may lower insurance rates, it is not a substitute for life and property insurance!

An automatic fire alarm system—typically made up of smoke detectors, heat detectors, manual pull stations, audible warning devices, and a fire alarm control panel (FACP) with remote notification capability—can provide early warning of a developing fire. Such a system, however, does not assure protection against property damage or loss of life resulting from a fire.

An emergency communication system—typically made up of an automatic fire alarm system (as described above) and a life safety communication system that may include an autonomous control unit (ACU), local operating console (LOC), voice communication, and other various interoperable communication methods—can broadcast a mass notification message. Such a system, however, does not assure protection against property damage or loss of life resulting from a fire or life safety event.

The Manufacturer recommends that smoke and/or heat detectors be located throughout a protected premises following the recommendations of the National Fire Protection Association Standard 72 (NFPA 72), manufacturer's recommendations, State and local codes, and the recommendations contained in the Guide for Proper Use of System Smoke Detectors, which is made available at no charge to all installing dealers. This document can be found at <http://www.systemsensor.com/appguides/>. A study by the Federal Emergency Management Agency (an agency of the United States government) indicated that smoke detectors may not go off in as many as 35% of all fires. While fire alarm systems are designed to provide early warning against fire, they do not guarantee warning or protection against fire. A fire alarm system may not provide timely or adequate warning, or simply may not function, for a variety of reasons:

Smoke detectors may not sense fire where smoke cannot reach the detectors such as in chimneys, in or behind walls, on roofs, or on the other side of closed doors. Smoke detectors also may not sense a fire on another level or floor of a building. A second-floor detector, for example, may not sense a first-floor or basement fire.

Particles of combustion or "smoke" from a developing fire may not reach the sensing chambers of smoke detectors because:

- Barriers such as closed or partially closed doors, walls, chimneys, even wet or humid areas may inhibit particle or smoke flow.
- Smoke particles may become "cold," stratify, and not reach the ceiling or upper walls where detectors are located.
- Smoke particles may be blown away from detectors by air outlets, such as air conditioning vents.
- Smoke particles may be drawn into air returns before reaching the detector.

The amount of "smoke" present may be insufficient to alarm smoke detectors. Smoke detectors are designed to alarm at various levels of smoke density. If such density levels are not created by a developing fire at the location of detectors, the detectors will not go into alarm.

Smoke detectors, even when working properly, have sensing limitations. Detectors that have photoelectronic sensing chambers tend to detect smoldering fires better than flaming fires, which have little visible smoke. Detectors that have ionizing-type sensing chambers tend to detect fast-flaming fires better than smoldering fires. Because fires develop in different ways and are often unpredictable in their growth, neither type of detector is necessarily best and a given type of detector may not provide adequate warning of a fire.

Smoke detectors cannot be expected to provide adequate warning of fires caused by arson, children playing with matches (especially in bedrooms), smoking in bed, and violent explosions

(caused by escaping gas, improper storage of flammable materials, etc.).

Heat detectors do not sense particles of combustion and alarm only when heat on their sensors increases at a predetermined rate or reaches a predetermined level. Rate-of-rise heat detectors may be subject to reduced sensitivity over time. For this reason, the rate-of-rise feature of each detector should be tested at least once per year by a qualified fire protection specialist. Heat detectors are designed to protect property, not life.

IMPORTANT! Smoke detectors must be installed in the same room as the control panel and in rooms used by the system for the connection of alarm transmission wiring, communications, signaling, and/or power. If detectors are not so located, a developing fire may damage the alarm system, compromising its ability to report a fire.

Audible warning devices such as bells, horns, strobes, speakers and displays may not alert people if these devices are located on the other side of closed or partly open doors or are located on another floor of a building. Any warning device may fail to alert people with a disability or those who have recently consumed drugs, alcohol, or medication. Please note that:

- An emergency communication system may take priority over a fire alarm system in the event of a life safety emergency.
- Voice messaging systems must be designed to meet intelligibility requirements as defined by NFPA, local codes, and Authorities Having Jurisdiction (AHJ).
- Language and instructional requirements must be clearly disseminated on any local displays.
- Strobes can, under certain circumstances, cause seizures in people with conditions such as epilepsy.
- Studies have shown that certain people, even when they hear a fire alarm signal, do not respond to or comprehend the meaning of the signal. Audible devices, such as horns and bells, can have different tonal patterns and frequencies. It is the property owner's responsibility to conduct fire drills and other training exercises to make people aware of fire alarm signals and instruct them on the proper reaction to alarm signals.
- In rare instances, the sounding of a warning device can cause temporary or permanent hearing loss.

A life safety system will not operate without any electrical power. If AC power fails, the system will operate from standby batteries only for a specified time and only if the batteries have been properly maintained and replaced regularly.

Equipment used in the system may not be technically compatible with the control panel. It is essential to use only equipment listed for service with your control panel.

Telephone lines needed to transmit alarm signals from a premises to a central monitoring station may be out of service or temporarily disabled. For added protection against telephone line failure, backup radio transmission systems are recommended.

The most common cause of life safety system malfunction is inadequate maintenance. To keep the entire life safety system in excellent working order, ongoing maintenance is required per the manufacturer's recommendations, and UL and NFPA standards. At a minimum, the requirements of NFPA 72 shall be followed. Environments with large amounts of dust, dirt, or high air velocity require more frequent maintenance. A maintenance agreement should be arranged through the local manufacturer's representative. Maintenance should be scheduled monthly or as required by National and/or local fire codes and should be performed by authorized professional life safety system installers only. Adequate written records of all inspections should be kept.

Limit-D-1-2013

Installation Precautions

Adherence to the following will aid in problem-free installation with long-term reliability:

WARNING - Several different sources of power can be connected to the fire alarm control panel. Disconnect all sources of power before servicing. Control unit and associated equipment may be damaged by removing and/or inserting cards, modules, or interconnecting cables while the unit is energized. Do not attempt to install, service, or operate this unit until manuals are read and understood.

CAUTION - System Re-acceptance Test after Software Changes: To ensure proper system operation, this product must be tested in accordance with NFPA 72 after any programming operation or change in site-specific software. Re-acceptance testing is required after any change, addition or deletion of system components, or after any modification, repair or adjustment to system hardware or wiring. All components, circuits, system operations, or software functions known to be affected by a change must be 100% tested. In addition, to ensure that other operations are not inadvertently affected, at least 10% of initiating devices that are not directly affected by the change, up to a maximum of 50 devices, must also be tested and proper system operation verified.

This system meets NFPA requirements for operation at 0-49° C/32-120° F and at a relative humidity 93% ± 2% RH (non-condensing) at 32°C ± 2°C (90°F ± 3°F). However, the useful life of the system's standby batteries and the electronic components may be adversely affected by extreme temperature ranges and humidity. Therefore, it is recommended that this system and its peripherals be installed in an environment with a normal room temperature of 15-27° C/60-80° F.

Verify that wire sizes are adequate for all initiating and indicating device loops. Most devices cannot tolerate more than a 10% I.R. drop from the specified device voltage.

Like all solid state electronic devices, this system may operate erratically or can be damaged when subjected to lightning induced transients. Although no system is completely immune from lightning transients and interference, proper grounding will reduce susceptibility. Overhead or outside aerial wiring is not recommended, due to an increased susceptibility to nearby lightning strikes. Consult with the Technical Services Department if any problems are anticipated or encountered.

Disconnect AC power and batteries prior to removing or inserting circuit boards. Failure to do so can damage circuits.

Remove all electronic assemblies prior to any drilling, filing, reaming, or punching of the enclosure. When possible, make all cable entries from the sides or rear. Before making modifications, verify that they will not interfere with battery, transformer, or printed circuit board location.

Do not tighten screw terminals more than 9 in-lbs. Overtightening may damage threads, resulting in reduced terminal contact pressure and difficulty with screw terminal removal.

This system contains static-sensitive components.

Always ground yourself with a proper wrist strap before handling any circuits so that static charges are removed from the body. Use static suppressive packaging to protect electronic assemblies removed from the unit.

Follow the instructions in the installation, operating, and programming manuals. These instructions must be followed to avoid damage to the control panel and associated equipment. FACP operation and reliability depend upon proper installation.

Precau-D1-9-2005

FCC Warning

WARNING: This equipment generates, uses, and can radiate radio frequency energy and if not installed and used in accordance with the instruction manual may cause interference to radio communications. It has been tested and found to comply with the limits for class A computing devices pursuant to Subpart B of Part 15 of FCC Rules, which is designed to provide reasonable protection against such interference when devices are operated in a commercial environment. Operation of this equipment in a residential area is likely to cause interference, in which case the user will be required to correct the interference at his or her own expense.

Canadian Requirements

This digital apparatus does not exceed the Class A limits for radiation noise emissions from digital apparatus set out in the Radio Interference Regulations of the Canadian Department of Communications.

Le présent appareil numérique n'émet pas de bruits radioélectriques dépassant les limites applicables aux appareils numériques de la classe A prescrites dans le Règlement sur le brouillage radioélectrique édicté par le ministère des Communications du Canada.

LiteSpeed™ and SWIFT™ are trademarks; and FireLite® Alarms is a registered trademark of Honeywell International Inc. Microsoft® and Windows® are registered trademarks of the Microsoft Corporation.

©2014 by Honeywell International Inc. All rights reserved. Unauthorized use of this document is strictly prohibited.

Software Downloads

In order to supply the latest features and functionality in fire alarm and life safety technology to our customers, we make frequent upgrades to the embedded software in our products. To ensure that you are installing and programming the latest features, we strongly recommend that you download the most current version of software for each product prior to commissioning any system. Contact Technical Support with any questions about software and the appropriate version for a specific application.

Documentation Feedback

Your feedback helps us keep our documentation up-to-date and accurate. If you have any comments or suggestions about our online Help or printed manuals, you can email us.

Please include the following information:

- Product name and version number (if applicable)
- Printed manual or online Help
- Topic Title (for online Help)
- Page number (for printed manual)
- Brief description of content you think should be improved or corrected
- Your suggestion for how to correct/improve documentation

Send email messages to:

FireSystems.TechPubs@honeywell.com

Please note this email address is for documentation feedback only. If you have any technical issues, please contact Technical Services.

Table of Contents

Section 1: Overview	9
1.1: Purpose	9
1.2: Assumed Knowledge	9
1.3: Additional References	9
1.4: Abbreviations	10
Section 2: W-GATE Wireless Gateway	11
2.1: Description	11
2.2: Agency Approvals	11
2.2.1: FCC	11
2.3: Specifications	12
2.3.1: Environmental Specifications	12
2.4: Magnet Sensors	12
2.4.1: Profile Magnetic Sensor	12
2.4.2: Mesh Formation Magnetic Sensor	12
2.5: LED Indicators	13
2.6: Installing the W-GATE	13
2.6.1: Before Installing	13
2.7: Mounting and Wiring	13
2.7.1: Mounting	13
2.7.2: Wiring	15
2.7.3: W-GATE Powered by the SLC	15
2.7.4: W-GATE Powered by an External, Regulated +24VDC source	16
2.8: Configuration and Programming	17
2.8.1: Configuration and Programming Without Using SWIFT Tools	17
Create a New Profile	17
Assign a Previously Created Profile Using a Distributor	18
Remove a Profile	18
Create a Mesh Network	18
2.8.2: Configuration and Programming Using SWIFT Tools	19
Assign a Profile	19
Remove a Profile	20
Create a Mesh Network	21
2.8.3: Profile Distribution	21
After Creating a Profile	22
Activating the Profile Magnetic Sensor	22
2.8.4: SLC Configuration	22
2.9: Operations	23
2.9.1: Modes of Operation	23
Start-up Mode	23
Factory Default Mode	23
Profile Configured	23
Mesh Formation	23
Initial Mesh Restructuring Mode	24
Normal Mode	24
Rescue Mode	24
Mesh Restructuring Mode	24
Bootloader Mode	25
2.9.2: LED Patterns	25
2.9.3: Lock/Unlock W-GATE	25
Lock/Unlock W-GATE Using SWIFT Tools	25
Password Reset	26
2.9.4: Weak Link Trouble Reporting	26
Disable Trouble Reporting at the W-GATE Using SWIFT Tools	26

2.9.5: Collapse Network Command.....	27
Collapse Mesh Network Using SWIFT Tools.....	27
2.9.6: Silence Network Command.....	28
Silence Mesh Network Using SWIFT Tools.....	28
2.9.7: Multiple Wireless Sensor Network Installation Restrictions.....	29
2.9.8: Avoiding RF Interference.....	30
Section 3: W-DIS-D Wireless Display Driver	31
3.1: Description.....	31
3.2: Agency Approvals	32
3.2.1: FCC.....	32
3.3: Specifications.....	32
3.3.1: Environmental Specifications.....	32
3.4: Magnetic Sensors.....	33
3.5: W-DIS-D LED Indicators	33
3.6: Mounting & Wiring.....	34
3.6.1: Mounting.....	34
3.6.2: Wiring.....	35
3.7: Configuration	36
3.7.1: Assign a Profile.....	36
Assigning a Profile Without Using SWIFT Tools.....	36
Assign a Profile Using SWIFT Tools.....	37
3.7.2: Mesh Formation.....	38
3.7.3: Removing Profiles	38
Restoring to Factory Default Without Using SWIFT Tools.....	38
Restoring to Factory Default Using SWIFT Tools.....	38
3.8: ANN-80W Configuration	39
3.9: W-DIS-D Operations	39
3.9.1: Modes of Operation Not in a Mesh Network	40
Bootloader.....	40
Factory Default	40
Profile Configured	40
3.9.2: Modes of Operation as a Mesh Participant.....	40
Mesh Formation Mode	40
Initial Mesh Restructuring Mode.....	40
Normal Mode.....	40
Rescue Mode	40
3.9.3: SLC Operation	41
3.9.4: LED Patterns.....	41
3.10: ANN-80W Operations	41
3.10.1: Annunciator Control Buttons and Visual Indicators	41
3.10.2: Audible Indicators	42
3.10.3: Event Messages	42
RF Comm Loss.....	42
Trouble Wireless Mesh Formation In Progress.....	42
Low Battery Event.....	42
Trouble Jamming Event.....	43
Trouble Duplicate Address.....	43
Trouble Class A Missing 2nd Link.....	43
Trouble Wireless Gateway Initializing.....	43
System Normal	43
Supervisory Tamper.....	43
Trouble Weak Link Low Signal Strength.....	43
Key Bus Trouble.....	43
Capacity Exceeded.....	44
Maximum Gateways.....	44
RF Device No Answer.....	44

3.10.4: Clearing messages	44
Section 4: Wireless Devices	45
4.1: Description.....	45
4.2: Agency Approvals	45
4.2.1: FCC.....	45
4.3: Specifications.....	46
4.4: Installing, Mounting, and Wiring Devices.....	46
4.5: Configuration and Programming	46
4.5.1: Assigning Profiles	46
Assigning a Profile to a Device (Detector or Module) Using a W-GATE or Distributor.....	46
Assigning a Profile Using SWIFT Tools.....	48
4.5.2: Distributor Mode	49
Converting a Device into a Distributor	49
Converting a Distributor Back into a Device	49
4.5.3: Mesh Formation.....	49
Repeater.....	50
4.5.4: Restoring a Device to Factory Default	50
Removing Profiles Without Using SWIFT Tools	50
Removing a Profile Using SWIFT Tools	50
4.6: Device Operations	51
4.6.1: Modes of Operation	51
Factory Default Mode.....	51
Site Survey Mode	51
Profile Assigned Mode.....	51
Bootloader Mode	52
Distributor Mode	52
Mesh Participant Modes	52
4.6.2: LED Indicators	52
Section 5: USB Adapter.....	53
5.1: Introduction.....	53
5.2: Agency Approvals	53
5.2.1: FCC.....	53
5.3: Specifications.....	54
5.3.1: Electrical Specifications	54
5.3.2: Serial Communication Specification.....	54
5.3.3: Mechanical Specifications.....	54
5.3.4: Environmental Specifications.....	54
5.4: Driver Installation	54
Appendix A: SWIFT Tools	58
A.1: Description.....	58
A.2: Launching SWIFT Tools.....	58
A.2.1: Creating a New Jobsite	59
A.2.2: Opening an Existing Jobsite	60
Appendix B: Site Survey	61
B.1: Conduct a Site Survey	61
B.1.1: Link Quality Test.....	61
Basic Requirements of a Link Quality Test	61
Conduct a Link Quality Test	61
Results of a Link Quality Test.....	62
After a Link Quality Test	62
B.1.2: RF Scan Test.....	63
Conduct an RF Scan Test	63
Status of an RF Scan Test.....	63
B.1.3: Retrieving Site Survey Results	63

- Appendix C: Troubleshooting and Testing 64**
 - C.1: Troubleshooting..... 64
 - C.2: Testing the W-GATE and Devices..... 66
 - C.2.1: Testing LED Indicators 66
 - C.3: Testing the Wireless Network 66
 - C.3.1: Network Topology 67
 - Parent-Child Devices 67
 - Orphan Devices 67
 - Class A Compliance 67
 - C.3.2: History Events..... 67
 - C.3.3: Network Snapshots 67
 - C.3.4: Network Statistics 67
 - C.3.5: Device Attributes 68
- Appendix D: LED Indicators 69**
- Index 75**

Section 1: Overview

1.1 Purpose

The SWIFT™ Network Manual provides an overview of the following:

- Wireless fire alarm system
- Instructions for installing and configuring the wireless devices
- Information on monitoring the status of the wireless devices
- Removal and replacement procedures of the W-GATE and W-DIS-D
- Testing, maintenance, and firmware upgrade information of the W-GATE and W-DIS-D

1.2 Assumed Knowledge

This document is created with the assumption that all users are familiar with working on a PC and laptop for configuration purposes. Installers should be familiar with the fire alarm and related service standards. The terminology and level of details of this document reflect this assumption.

1.3 Additional References

The table below provides a list of documents referenced in this manual, as well as documents for selected other compatible devices.

Fire•Lite SLC Wiring Manual	51309
MS-9200UDLS Fire Alarm Control Panel	52750
ANN-80 Series Remote Fire Annunciator	52749
W-SD355 Wireless LiteSpeed Photo Detector	I56-4081
W-SD355T Wireless LiteSpeed Photo/Heat Detector	I56-4081
W-H355R Wireless LiteSpeed Rate Of Rise Heat Sensor	I56-4082
W-H355 Wireless LiteSpeed Fixed Heat Sensor	I56-4082
W-MMF Wireless Monitor Module	I56-4083

Table 1.1 Related Documentation

1.4 Abbreviations

The following table lists the abbreviations and their definitions used in this manual.

Abbreviation	Definition
AHJ	Authority Having Jurisdiction
ANSI	American National Standards Institute
dBm	Units of RF power (0dBm = 1mW)
FACP	Fire Alarm Control Panel
FCC	Federal Communications Commission
ISM Band	Industrial, Scientific and Medical Radio Bands
LCD	Liquid Crystal Display
LED	Light Emitting Diode
mA	Milliampere
MHz	Megahertz
NFPA	National Fire Protection Association
PC	Personal Computer
RF	Radio Frequency
SLC	Signaling Line Circuit
UI	User Interface
UL	Underwriters Laboratories
W-DIS-D	Wireless Display Driver
W-GATE	Wireless Gateway

Section 2: W-GATE Wireless Gateway

2.1 Description

The W-GATE is a device in a wireless fire system that acts as a bridge between fire alarm control panels (FACPs) and wireless fire devices. All wireless fire devices communicate with the W-GATE over the wireless network formed by the devices and the W-GATE.

The SWIFT Wireless Sensor Network includes a W-DIS-D (Wireless Display Driver). The W-DIS-D and an ANN-80W are required for the display of wireless-specific events. The W-DIS-D and ANN-80W are explained in detail in Section 3.

The W-GATE is powered by either the SLC loop or by any external +24VDC UL listed power supply. The W-GATE uses the LiteSpeed protocol on the SLC to communicate with the panel and a proprietary wireless protocol to communicate with wireless fire devices. The following graphic is an illustration of the components of the SWIFT Network.

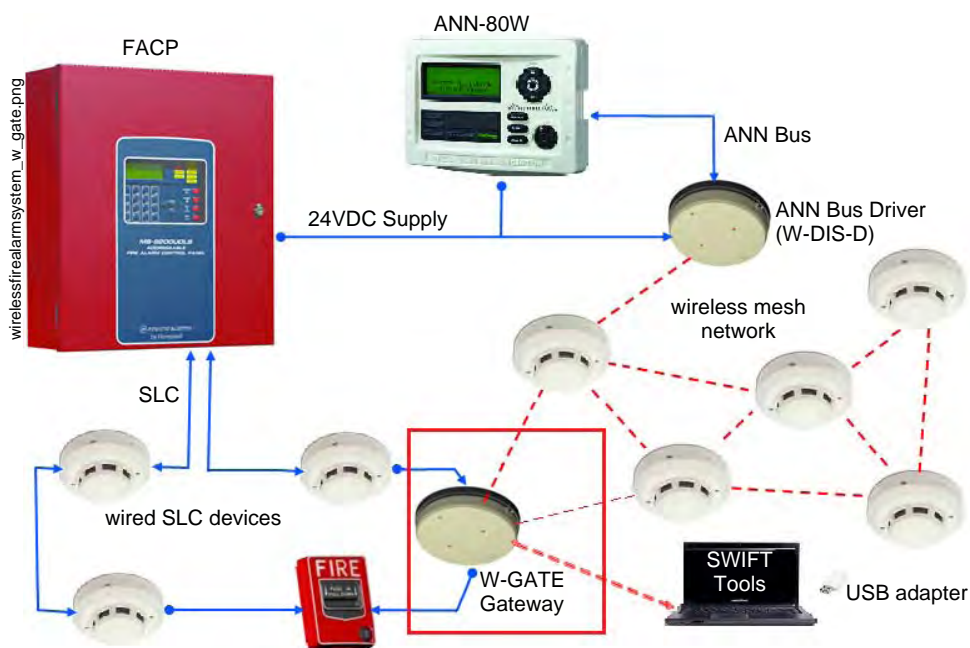

Figure 2.1 SWIFT Network

2.2 Agency Approvals

2.2.1 FCC

This device complies with part 15 of the FCC Rules. Operation is subject to the following two conditions:

1. This device may not cause harmful interference, and
2. This device must accept any interference received, including interference that may cause undesired operation.

FCC ID: PV3WFSGW



**WARNING: DO NOT MAKE CHANGES TO THE EQUIPMENT
CHANGES OR MODIFICATIONS NOT EXPRESSLY APPROVED BY THE MANUFACTURER
COULD VOID THE USER'S AUTHORITY TO OPERATE THE EQUIPMENT.**

2.3 Specifications

Following are the specifications of the W-GATE.

Specifications	Data
External Supply Electrical Ratings	18V-30V
SLC Electrical Ratings	15V-30V
Maximum current when using the external supply	40mA
Maximum current when using the SLC power supply	24mA
Maximum SLC Resistance	50Ω
Minimum signal strength level needed at the receiver for a primary path with weak link trouble reporting enabled.	-50dBm
Minimum signal strength level needed at the receiver for a secondary path or primary path with weak link trouble reporting disabled.	Must be 18 dBm higher than the noise floor down to a minimum of -80dBm ¹
Maximum ambient noise level	-85dBm ¹
Maximum RF Power Output	+17dBm (Tx power level without antenna)
Radio Frequency	Lower ISM Band (902 - 928MHz).

¹ Ensure that the primary path signal strength level is within recommended guidelines to assure proper communication in the mesh network.

2.3.1 Environmental Specifications

System	Operating Temperature	Storage Temperature	Humidity
W-GATE	0°C-49°C / 32°F-120°F	-10°C- 60°C / 14°F-140°F	10 to 93% RH Non-condensing

2.4 Magnet Sensors

2.4.1 Profile Magnetic Sensor

The profile magnetic sensor (refer to Figure 2.2) is used to create a unique profile upon start-up. It can also be used to start profile distribution for a W-GATE that contains a profile. The LED next to the profile magnet sensor turns on green for ½ a second when the sensor is activated.

2.4.2 Mesh Formation Magnetic Sensor

The mesh formation magnetic sensor (refer to Figure 2.2) toggles the W-GATE in and out of mesh formation mode. The initial activation of the sensor puts the W-GATE in mesh formation mode (as long as it contains a profile). A subsequent activation of the magnetic sensor toggles the W-GATE out of mesh formation and into the initial mesh restructuring and normal mode. The W-GATE can be placed back into mesh formation mode by activating the magnet sensor once again. The LED next to the profile magnet sensor turns on green for ½ a second when the sensor is activated.

The Mesh formation magnetic sensor can also be used to create a profile on start-up for a W-GATE that does not already contain a profile.

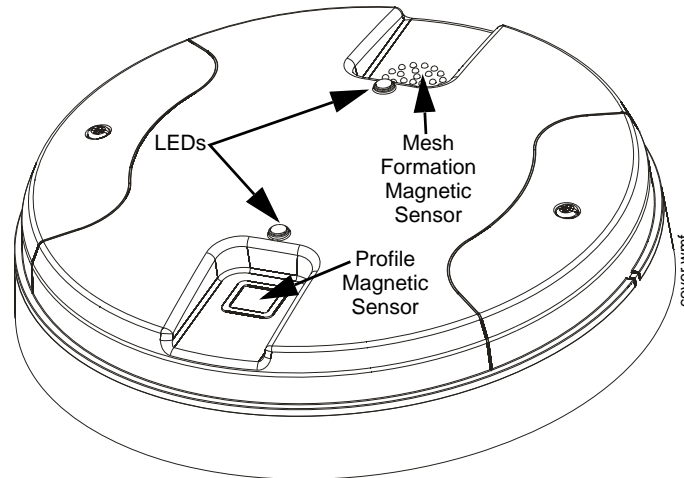

Figure 2.2 LEDs and Magnetic Sensors on W-GATE

2.5 LED Indicators

The two LEDs on the W-GATE blink in the same pattern to allow the LED to be viewed from any angle. LED patterns are explained in Appendix D.

2.6 Installing the W-GATE

2.6.1 Before Installing

Choose a location for the W-GATE that is clean, dry, and vibration-free. The area should be readily accessible with sufficient room to easily install and maintain the W-GATE. Metal obstructions impede the radio frequency communication and should be avoided. Carefully unpack the system and inspect for shipping damage if any. All wiring must comply with the national and local codes for fire alarm systems.

2.7 Mounting and Wiring



WARNING: FORMEX SHEET
ENSURE THAT THE FORMEX SHEET INSIDE THE GATEWAY IS NOT REMOVED OR TAMPERED WHILE INSTALLING OR CLEANING.

2.7.1 Mounting

The W-GATE has two major pieces, the cover and the mounting plate. The mounting plate is mounted to the wall or ceiling, and field wiring is connected to it. The cover contains the printed circuit board and is fastened to the mounting plate once the wiring is completed.

Mount the mounting plate directly to an electrical box on the ceiling or wall. The plate mounts directly to a 4" square (with and without plaster ring), 4" octagon, 3 1/2" octagon, single gang or double gang junction boxes. If an electrical box is not available, the mounting plate can be mounted to any flat surface and the wiring can be connected via the knockout points in the mounting plate.

To mount the W-GATE:

1. Pull the wiring through the opening in the mounting plate.

2. Mount the mounting plate to the junction box or ceiling. See Figure 2.3 below.
3. Connect field wiring to the terminals, as described in Section 2.7.2.
4. Connect necessary jumpers where applicable, as described in Section 2.7.3.
5. To mount the cover, align the locating pins on the cover to the corresponding slots in the mounting plate. See Figure 2.4.
6. Secure the cover by tightening the mounting screws.

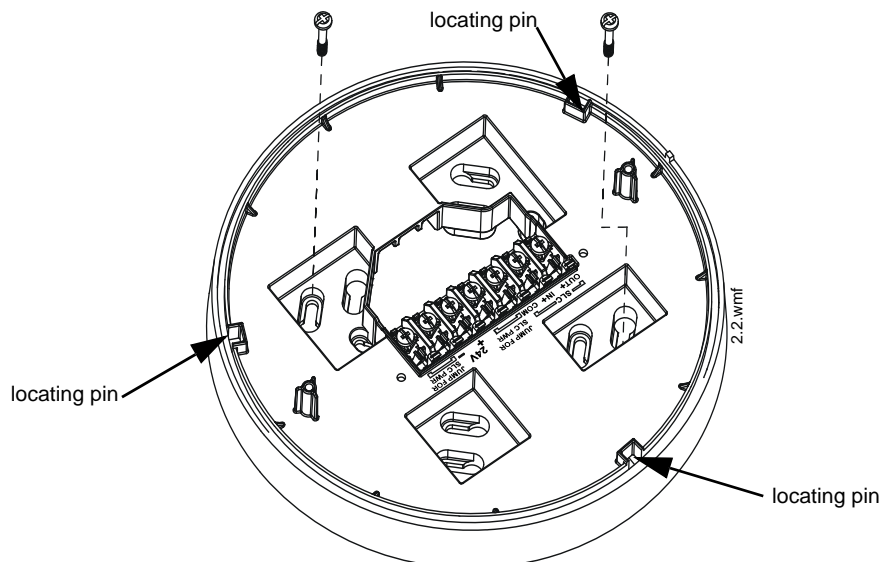

Figure 2.3 Mounting Plate for Wireless Gateway

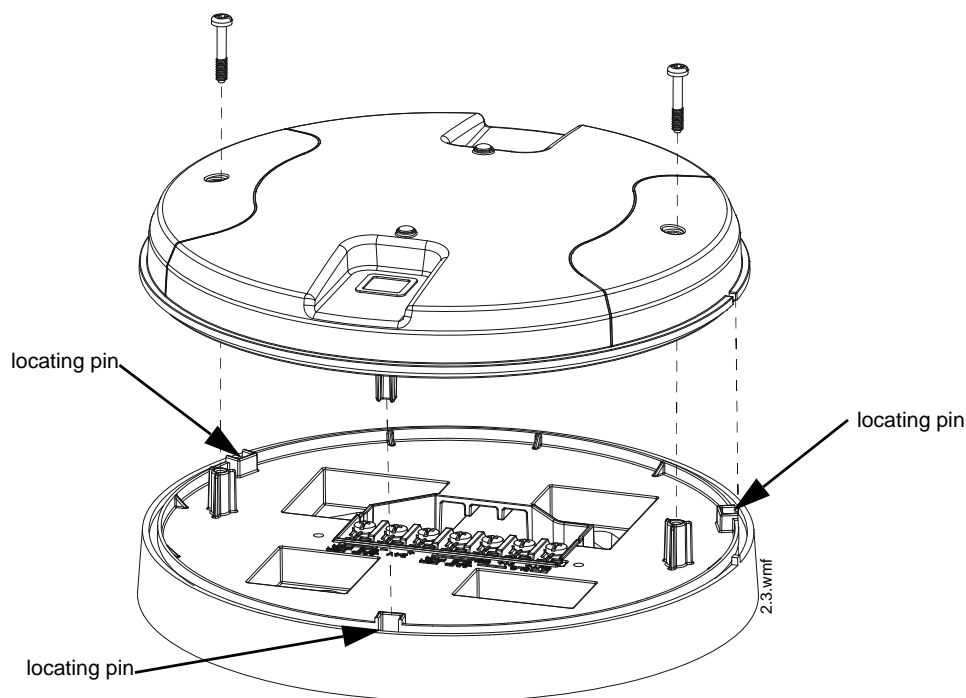

Figure 2.4 Attaching Cover to Mounting Plate

2.7.2 Wiring

- All wiring must be installed in compliance with the National Electrical Code and the local codes having jurisdiction.
- 12-18 AWG is recommended.

For wiring connections:

1. Strip about 3/8” of insulation from the end of the wire.
2. Slide the stripped end of the wire under the appropriate terminal and tighten the screw.



NOTE: Do not loop the wire under the screw terminals.

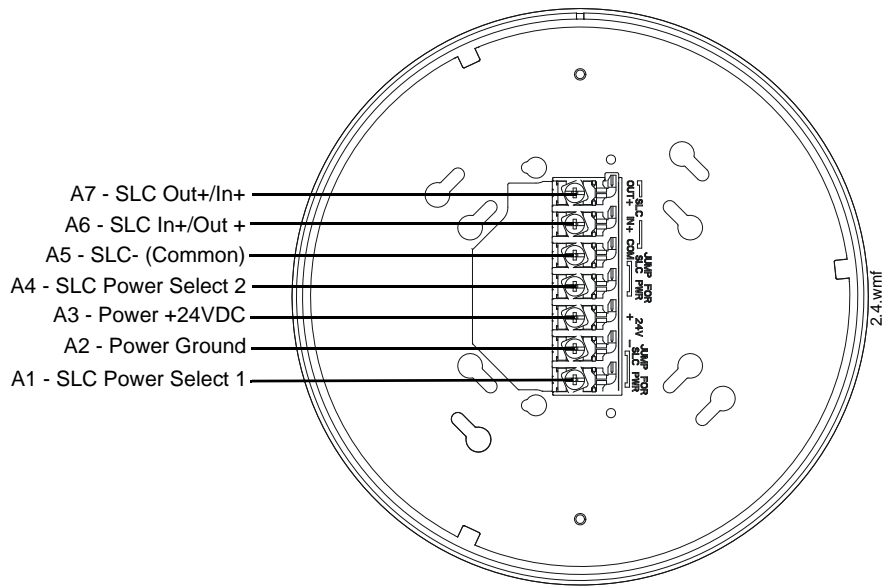

Figure 2.5 W-GATE Mounting Plate - Terminal Layout

2.7.3 W-GATE Powered by the SLC

To power the W-GATE using the signaling line circuit, connect the W-GATE as described in the table and graphic below:

Terminal Pins	Description
A5 and A7	SLC - (Common) & SLC Output +
A5 and A6	SLC - (Common) & SLC Input +
A4 and A5	Jumper selection to enable power from the SLC supply. (Insert Jumper when using SLC power.)
A3	Unused
A1 and A2	Jumper selection to enable power from the SLC supply. (Insert Jumper when using SLC power.)

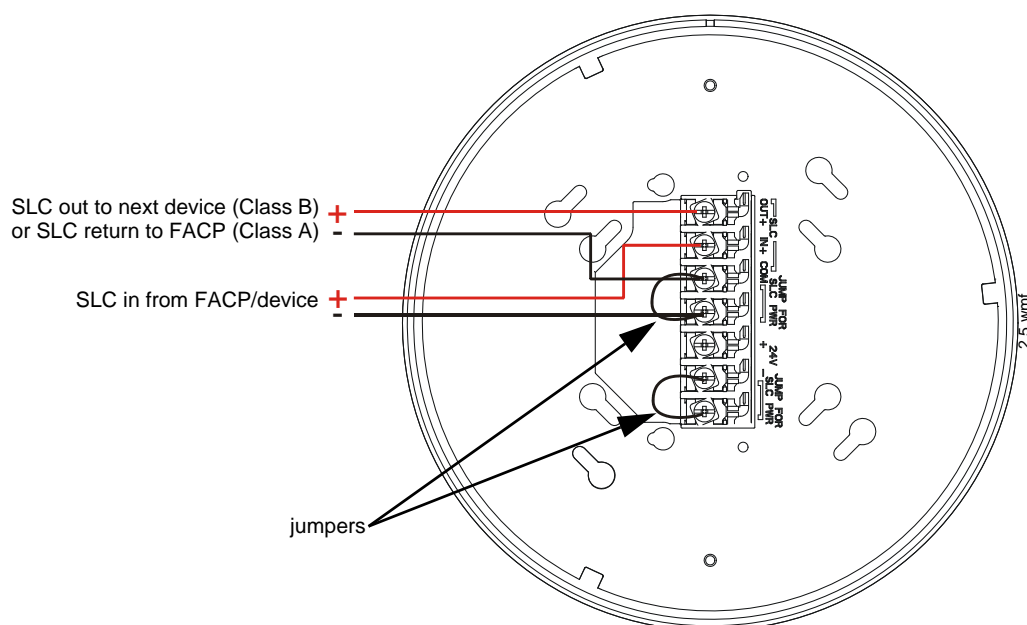

Figure 2.6 Wiring Connections: W-GATE Powered by the SLC



NOTE: Use of the same wire gauge is recommended if there are multiple connections to the same terminal.

The W-GATE provides isolation of short circuits on the SLC in Class A (Style 6) installations. SLC connections are power-limited by the panel. An interruption in the SLC that causes a loss of power at the W-GATE for more than 100ms may result in a trouble condition and loss of fire protection provided by the wireless devices for approximately 15 minutes. Use of an external +24V power source (not SLC power) is recommended for installations that require fire protection in the presence of short circuits, including Class A applications and applications that use isolator modules. Refer to the *SLC Wiring Manual* for more information on wiring using isolators.

2.7.4 W-GATE Powered by an External, Regulated +24VDC source

To power the W-GATE using an external, regulated +24VDC source, connect the W-GATE as described in the table and drawing below.

Terminal Pins	Devices Powered
A5 & A7	SLC Output
A5 & A6	SLC Input
A4	Unused
A2 & A3	+24VDC input. Voltage range from +18VDC to +30VDC. Use only power-limited device circuits.
A1	Unused

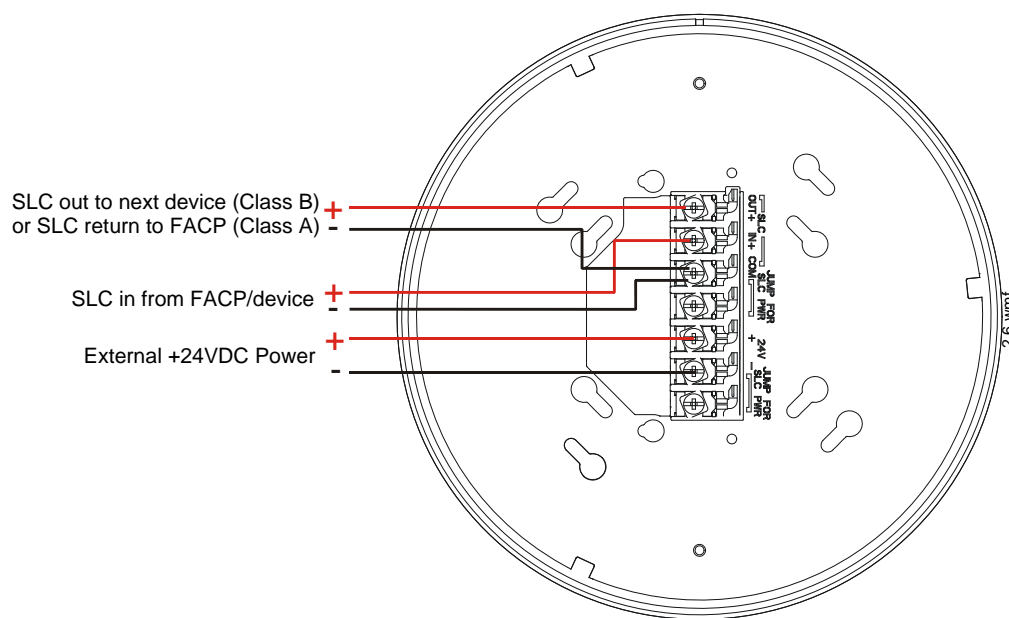

Figure 2.7 Wiring Connections: W-GATE Powered by an External, Regulated +24VDC Source



NOTE: It is recommended to use the same wire gauge if there are multiple connections to the same terminal.

The W-GATE provides isolation of short circuits of the SLC in Class A (Style 6) installations. SLC connections are power-limited by the panel. +24VDC must be power-limited by the source.

2.8 Configuration and Programming

To successfully configure and/or program the W-GATE:

1. Create a profile. A profile binds a W-GATE and the devices in a mesh network together. The profile will contain a mesh ID that is used when forming the associations. All devices, including the W-GATE, require a common profile.
2. Distribute the profile. Distribute the profile to every device that will be a part of the mesh. This will enable all the devices that have that profile to form associative links when the mesh is formed.
3. Form the mesh. The mesh cannot be formed until the profile is assigned to the W-GATE and distributed to its devices.

These steps may be performed with or without using SWIFT Tools.

2.8.1 Configuration and Programming Without Using SWIFT Tools

This section explains the configuration of the W-GATE using only a magnet and a screw driver. For configuration instructions using SWIFT Tools, refer to Section 2.8.2.

There are two ways to provide a W-GATE with a profile without using SWIFT Tools.

- ✓ Create a new profile using the W-GATE.
- ✓ Assign a previously created profile to the W-GATE using a distributor.

Create a New Profile

To create a unique profile in the W-GATE without using SWIFT Tools:

1. Start with the W-GATE powered off. The profile creation process is performed during start-up.
2. Power on the W-GATE using SLC power or external +24V. Refer to Sections 2.7.3 and 2.7.4 for more information.
3. Ensure that the W-GATE is in the factory default state. If the W-GATE is in the factory default state, both the LEDs on the W-GATE will double blink red every second for ten seconds. If the LEDs are yellow, refer to “Remove a Profile” on page 18.
4. Activate either magnetic sensor with a magnet within ten seconds of starting up the W-GATE while the double red blink is active on the W-GATE. Refer to Section 2.4, “Magnet Sensors” for further information on activating magnetic sensors. The LED next to the magnetic sensor emits a red light for one second when it is activated. If the ten second window is missed, power down the W-GATE and repeat the process starting at step 1.

A profile has been created successfully; the LEDs on the W-GATE will light green and stay on steady for ten seconds. The profile has been created containing a mesh ID and a default password. The default password is ‘12345’ and is needed if the W-GATE is locked by the FACP and later accessed by SWIFT Tools.

Assign a Previously Created Profile Using a Distributor

Instead of creating a new profile, an existing profile can be distributed by a device with an existing profile. To distribute the existing profile:

1. Ensure that the W-GATE or other mesh device with the profile is set for distribution. Refer to Section 2.8.3, “Profile Distribution” or Section 4.5.2, “Distributor Mode”.
2. Bring the profile distributor within 20 feet of the W-GATE.
3. 10 seconds after the initial start-up, the LEDs on the W-GATE switch from a double red blink to a single red blink. The single red blink indicated the gateway is ready.
4. Use a magnet to activate either of the magnetic sensors. The LED will blink a single red every half-second indicating that it is searching for a profile.

When the profile is successfully received from the distributor, the LEDs on the W-GATE will turn on green steady for five seconds.

Remove a Profile

To remove a profile from a W-GATE:

1. Start with the W-GATE powered off. The process is performed during start-up.
2. Power on the W-GATE using SLC power or external +24V. Refer to Sections 2.7.3 and 2.7.4 for more information.
3. Verify the W-GATE is in the profile modification state. The W-GATE is in the profile modification state when both the LEDs on the W-GATE double blink yellow every second for ten seconds.
4. Activate both magnetic sensors on the W-GATE within ten seconds of start-up while the double yellow blink is active. If the ten second window is missed, power down the W-GATE and repeat the process starting at step 1.

The LEDs on the W-GATE will blink green every second for five seconds indicating that the profile is removed.

Create a Mesh Network

The W-GATE communicates with all devices in range that have a common profile and establishes communication links with all the devices. This creates a mesh network. Once a device joins the mesh, that device acts as a repeater for devices out of the range of the W-GATE. **All devices must be in their final mounting locations prior to initiating the mesh formation.** The mesh formation is initiated by the W-GATE upon user activation and terminated by the W-GATE when all possible devices join the network or when terminated by the user.

To form a mesh network, ensure that the W-GATE is powered on and contains a profile. (Refer to Section 2.5 on page 13 for information on how the W-GATE indicates its status). Activate the “Mesh Formation” magnet sensor on the W-GATE. Refer to Figure 2.2 for sensor location.

The W-GATE will then transition to the mesh formation mode and establish communication with all the devices containing a common profile. The blink pattern in W-GATE indicates that it is in mesh formation mode. At this stage, both the LEDs on the W-GATE will blink twice every 7 seconds.

- The first blink is green and the second blink is red when the W-GATE is acting as a profile distributor and forming the mesh.
- The first blink is green and the second blink is yellow when the W-GATE is only forming the mesh.

Mesh formation typically takes one minute for each device in the mesh. Mesh formation automatically terminates 10 minutes after the last device joins the mesh. Mesh formation can be terminated manually by the user by again activating the mesh formation magnetic sensor.

Once the mesh formation is complete, the network automatically transitions to restructure the mesh. For operating instructions, refer to Section 2.9, “Operations”.

2.8.2 Configuration and Programming Using SWIFT Tools

Assign a Profile

To assign a profile to the W-GATE using SWIFT Tools:

1. Connect the W-USB dongle device to your laptop. For more information on the USB dongle, refer to Section 5, “USB Adapter”, on page 53.
2. Launch SWIFT Tools. Refer to Appendix A for more information.
3. From the Home Screen, select the **Create Mesh Network** function.
4. **Create** a new profile or **Import** an existing profile as required.
5. Select and open the profile to be assigned to the W-GATE from the Name drop-down box in the Profile section.

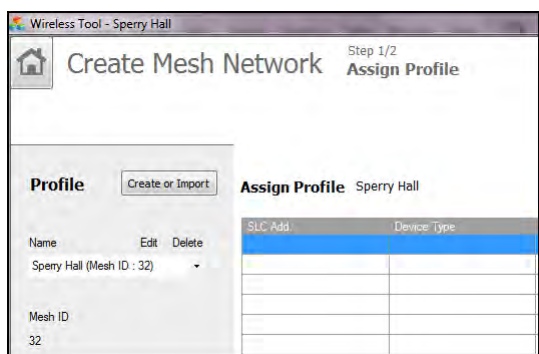

Figure 2.8 Creating or Importing a Profile

6. Power on the W-GATE within approximately 20 feet of the laptop running SWIFT Tools.
7. Ensure that the **Scan On** selection box in the **Communicator Window** is checked.

- Select the W-GATE from the **Communicator Window** on the right side of the Tools screen.

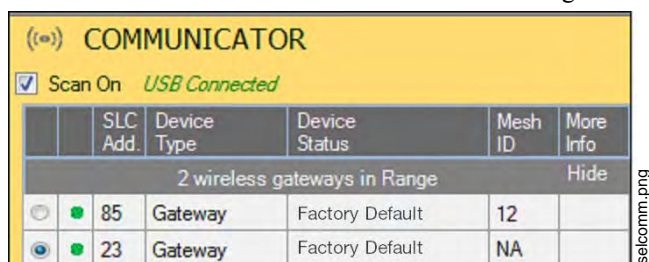

Figure 2.9 Gateway Selection

- Click **Assign**.

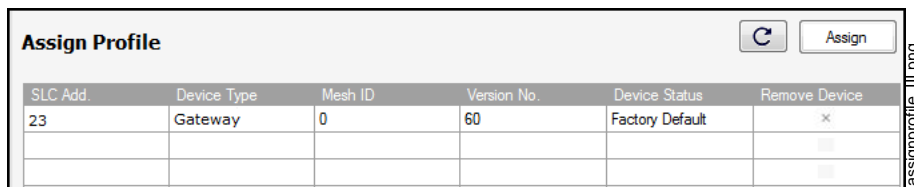

Figure 2.10 Assign a Profile

The W-GATE is now included in the list of devices with a profile assigned. The LEDs on the W-GATE will turn on green for 10 seconds after the profile has been received.

Remove a Profile

To remove a profile from a W-GATE using the SWIFT Tools application:

- Connect the W-USB dongle device to your laptop. For more information on the USB dongle, refer to Section 5, “USB Adapter”, on page 53.
- Launch SWIFT Tools. Refer to Appendix A, “SWIFT Tools” for more information on launching the SWIFT Tools application.
- From the Home Screen, select the **Site Survey**, **Create Mesh Network**, or **Diagnostics** function.
- Click **Extras** and select **Set device to factory default**.

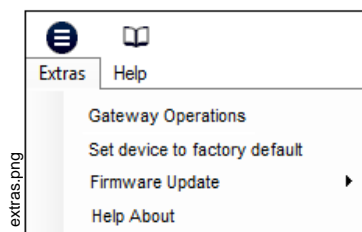

Figure 2.11 Extras Menu

- The **Reset Devices** screen appears, displaying the W-GATE and other devices that have a profile assigned. Click to select the W-GATE and click **Reset Device** to remove the profile.

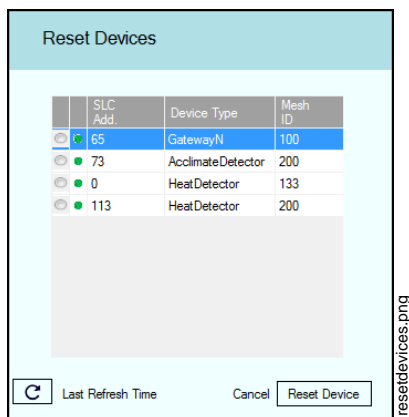

Figure 2.12 Reset Devices Screen

The profile is removed and the W-GATE is reset to factory default state.

Create a Mesh Network

To create a mesh network using the SWIFT Tools, perform the following steps.

- Connect the W-USB dongle device to your laptop. For more information on the USB dongle, refer to Section 5, “USB Adapter”, on page 53.
- Launch SWIFT Tools. Refer to Appendix A for more information.
- From the Home Screen, select the **Create Mesh Network** function.
- Proceed to the second step of the **Create Mesh Network** function by clicking the arrow marked **Next** at the top of the screen.
- Click to select the desired W-GATE displayed in the **Gateways in Range** table and then click **Start Mesh Formation**.

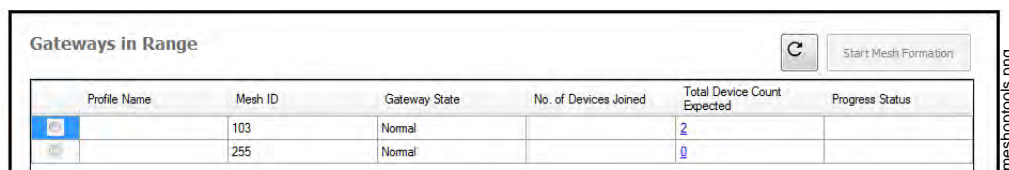

Figure 2.13 Gateways in Range Table

While the mesh is formed, SWIFT Tools helps track the number of devices that have joined the mesh and view the progress. Mesh formation terminates 10 minutes after the last device joins the mesh. In addition, mesh formation can be manually terminated by clicking the **Start Mesh Restructuring** button.

Once mesh formation is complete, the network automatically transitions to restructure the mesh. For further operating instructions, refer to Section 2.9, “Operations”.

2.8.3 Profile Distribution

There are two ways to initiate profile distribution from the W-GATE.

- Automatically after creating a profile if the profile was *not* created by SWIFT Tools
- Activating the profile-creating magnetic sensor when the W-GATE has a profile.

After Creating a Profile

Profile distribution is automatically enabled from the W-GATE after creating a profile using either magnetic sensor upon W-GATE start-up. The profile distribution automatically terminates after 10 minutes.

Activating the Profile Magnetic Sensor

Activating the profile magnetic sensor (refer to Figure 2.2) when the W-GATE has a profile will put the W-GATE in a mode of distributing the profile to any device that requests a profile. The W-GATE's LED pattern will be altered when it is distributing a profile for easy identification. Profile distribution will automatically terminate after 10 minutes. For more information on W-GATE LED patterns, refer to Section 2.5 on page 13.

2.8.4 SLC Configuration

The W-GATE:

- ✓ communicates with the control panel via the SLC.
- ✓ is a LiteSpeed-only device.
- ✓ does not support CLIP mode.
- ✓ requires the use of an ANN-80W for event details because FACPs have limited support for displaying all troubles from the wireless device. Refer to the appropriate section below for configuration steps.

Three consecutive SLC addresses are used for a W-GATE. Set the base address using the rotary dials on the W-GATE prior to installation. Ensure the address and the next two addresses on the SLC loop are available.

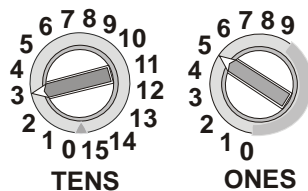

Figure 2.14 Address Rotary Switches

SLC-setaddrph.wmf

The base address uses the following configuration parameters:

- Module Type: Monitor

The W-GATE does not cause any alarms at this address, but the SLC point is used for supervision of the W-GATE.

The base address +1 uses the following configuration parameters:

- Module Type: Tamper Monitor

This address is a latching supervisory condition that goes active whenever a wireless detector in the mesh is removed from its base or a module has its cover plate removed (tamper). This SLC point does not show the address of the tampered device. The ANN-80W displays the device address information. The latching condition is cleared with a reset on the ANN-80W.

The base address +2 uses the following configuration parameters:

- Module Type: Trouble Monitor

This address is a latching or non-latching trouble condition, depending on the trouble event, that goes active whenever a wireless device in the mesh is in a trouble condition. Refer to Section 3.10.3, “Event Messages”, on page 42 for the message displayed at the ANN-80W for the trouble event. Latching troubles are cleared with a reset on the ANN-80W.

The specific address and trouble condition is displayed on the ANN-80W.

2.9 Operations

2.9.1 Modes of Operation

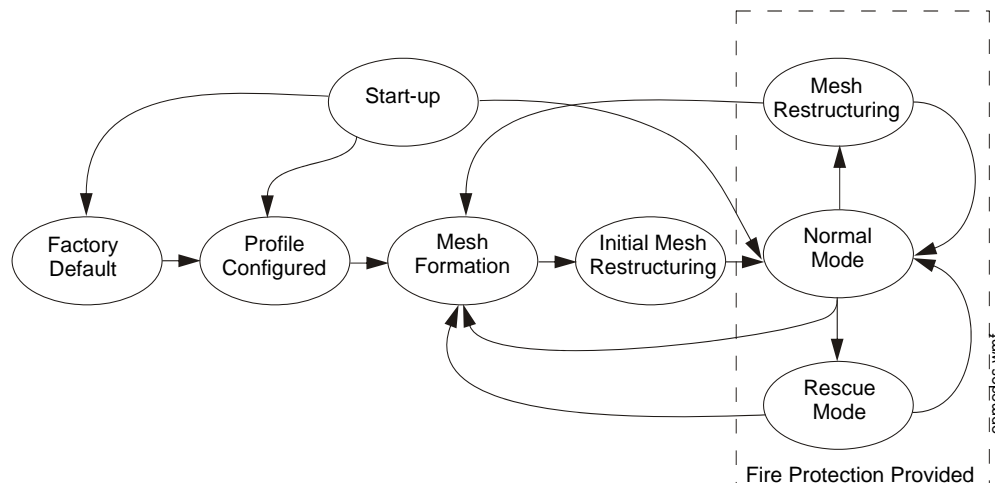

Figure 2.15 W-GATE Modes Of Operation

Start-up Mode

Start-up mode is a temporary mode of operation. During start-up mode a profile can be created or removed. The start-up period lasts for 10 seconds. If a particular unit contains a profile, the LEDs double blink yellow every second. If the unit does not contain a profile, the LEDs double blink red every second.

During start-up, the W-GATE does not provide fire protection nor does it respond to the FACP. All the three SLC addresses will be an INVALID REPLY.

After start-up, the W-GATE proceeds to the **factory default** mode if no profile exists. In the presence of a profile, the W-GATE will proceed to **mesh formation** mode if it was previously part of a mesh network or **normal mode** if it was *not* previously part of a mesh network.

Factory Default Mode

Factory default mode is the initial mode of the W-GATE. In this mode, the W-GATE and peripheral devices do not provide any fire protection. The W-GATE does not communicate with wireless detectors or modules in factory default mode. The only wireless communication in factory default mode is between the W-GATE and SWIFT Tools. SWIFT Tools must be within 20 feet of the W-GATE for proper communication. The W-GATE must be assigned a profile before continuing configuration.

The W-GATE reports “Factory Default” to the communicator display of SWIFT Tools.

The W-GATE’s base address will be normal and the supervisory point (base address + 1) will also be normal. The trouble point (base address + 2) will indicate an open circuit.

Profile Configured

The W-GATE enters the profile configured mode once a profile is assigned by SWIFT Tools or a distributor; or after creating a profile using the magnetic sensor. Profile configured mode is a temporary mode before the W-GATE transitions to mesh formation or normal mode.

Mesh Formation

The W-GATE must have a profile before entering mesh formation mode. The W-GATE and the peripheral devices do not provide any fire protection in this mode. The W-GATE enters mesh formation mode:

- ✓ after creating a profile using the mesh formation sensor.

- ✓ after activating the mesh formation sensor with a magnet when the W-GATE contains a profile.
- ✓ automatically after start-up when the W-GATE was previously part of a mesh.
- ✓ by a command from the SWIFT Tools application.

A W-GATE in mesh formation mode instructs all devices in the mesh to also transition to mesh formation mode. The W-GATE and all communicating devices search for new or lost devices with the same profile to join the network.

If the W-GATE automatically entered mesh formation after start-up, mesh formation will terminate 10 minutes after the last device has joined or after all existing devices are recovered. If new devices are found or if mesh formation was initiated by the user, then mesh formation terminates after a period of 10 minutes without any new devices joining the mesh. At any point Mesh formation can be terminated by user interaction by activating the magnet sensor again or by using the SWIFT Tools application.

The W-GATE reports “Mesh Formation” to the communicator display of the SWIFT Tools application.

The W-GATE’s base address will be normal and the supervisory point (base address + 1) will also be normal. The trouble point (base address + 2) will indicate an open circuit.

Initial Mesh Restructuring Mode

Initial mesh restructuring mode automatically runs after each **mesh formation**. The W-GATE and peripheral devices do not provide fire protection during the initial mesh restructuring mode. Mesh restructuring analyzes signal strengths between devices. The W-GATE designates the primary and secondary communication paths between devices that provide a redundant path for all transmissions. Mesh restructuring automatically terminates once all devices have a redundant communication path and signal strengths that meet the requirements of primary and secondary transmission paths. Any device that does not have a redundant path or meet the requirements for signal strength will report a fault.

The W-GATE reports “Restructuring” to the communicator display of the SWIFT Tools application.

The W-GATE’s base address will be normal and the supervisory point (base address + 1) will also be normal. The trouble point (base address + 2) will indicate an open circuit.

Normal Mode

Normal mode is the network’s standard operating state. The mesh network has been formed and is providing fire protection. The mesh network will continuously search for additional devices with a matching profile to join the mesh. To avoid interference, the mesh network periodically checks for adjacent mesh networks created by Honeywell. The W-GATE reports “Normal” to the communicator display of the SWIFT Tools application.

Rescue Mode

During normal mode, if an out-of-network device with a matching profile is discovered by the network, the W-GATE will trigger rescue mode in all communicating devices. All devices in communication continue to provide fire protection during rescue mode but also search for a lost or added device. Rescue mode automatically terminates 3 minutes after the last device is rescued and returns to normal mode. The W-GATE does not report troubles during rescue mode but reports “Rescue” to the communicator display of the SWIFT Tools application.

Mesh Restructuring Mode

In addition to the initial mesh restructuring mode, mesh restructuring is automatically performed after any restoration of communication to a device or to recover from a link failure (Class A fault). Mesh restructuring that occurs during normal mode does not generate a trouble message. During

mesh restructuring, fire protection is provided by all devices that are participating in the mesh communication. The W-GATE reports “Restructuring” to the communicator display of the SWIFT Tools application.

Bootloader Mode

The W-GATE enters the bootloader mode when its firmware is being updated using SWIFT Tools. The W-GATE does not communicate with the FACP during bootloader mode. The W-GATE reports “Bootloader” to the communicator display of the SWIFT Tools application.

2.9.2 LED Patterns

The LED indicator patterns are provided in Appendix D on page 69.

2.9.3 Lock/Unlock W-GATE

The W-GATE can be locked to prevent access to the magnetic sensors and to password-protect all wireless interactions. The lock function can be performed by SWIFT Tools. When SWIFT Tools is used to lock the W-GATE, a password must be provided for all future interactions, including unlocking the W-GATE. If the W-GATE was previously locked with a password from SWIFT Tools, the previous password will be applied. Use this password for all future interactions with the SWIFT Tools application.

Lock/Unlock W-GATE Using SWIFT Tools

To lock/unlock the W-GATE:

1. Connect the W-USB dongle device to your computer. For more information on USB dongle, refer to Section 5.
2. Launch the SWIFT Tools application. Refer to Appendix A, “SWIFT Tools” for more information.
3. From the Home Screen, select the **Site Survey**, **Create Mesh Network**, or **Diagnostics** function.
4. Click **Extras**. The following screen is displayed.

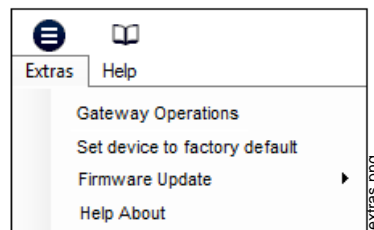

Figure 2.16 Extras Menu

5. Select **Gateway Operations** to lock/unlock the gateway. The **Lock/Unlock gateway** screen appears, displaying the W-GATE that is locked.



Figure 2.17 Lock/Unlock Screen

6. Select desired gateway and click **Lock** or **Unlock** as required.
 - **Lock** - The **Lock Gateway** screen is displayed. Create a password and click **Lock**. The gateway is locked.
 - **Unlock** - The **Enter password for Gateway** screen is displayed. Enter the password and click **Unlock**. The W-GATE is unlocked.

Password Reset

To reset the password, contact technical support.

2.9.4 Weak Link Trouble Reporting

The SWIFT Network uses two paths of communication for each device. To establish the link between devices as a viable communication path, the signal strengths must meet the limits provided in Section 2.3. The SWIFT Network implements a higher threshold for primary connections to provide an extra layer of robustness and immunity from interference. A weak link trouble condition is initiated for any device that does not have at least one connection at the primary threshold. This is an optional setting that can be disabled to ignore the weak link trouble condition. The trouble can be disabled at the W-GATE.

Disable Trouble Reporting at the W-GATE Using SWIFT Tools

To disable trouble reporting at the W-GATE through SWIFT Tools:

1. Connect the W-USB dongle device to your computer. For more information on the USB dongle, refer to Section 5.
2. Launch the SWIFT Tools application. Refer to Appendix A, “SWIFT Tools” for more information.
3. From the Home Screen, select the **Diagnostics** function.
4. Select the desired W-GATE from the communicator panel.



Figure 2.18 Communicator Panel

5. Click **View Mesh**.

- Click **Advanced Functions**. A drop-down list is displayed.

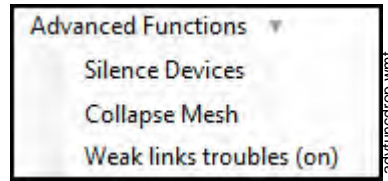

Figure 2.19 Advanced Functions Options

- Click **Weak links troubles (On)**. The **Report weak links troubles** screen is displayed.

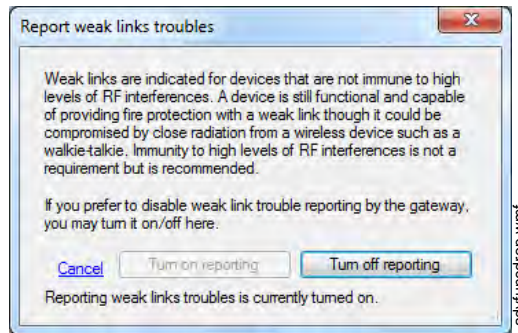

Figure 2.20 Report Weak Links Troubles Option

- Click **Turn off reporting**. The trouble reporting is now disabled.

2.9.5 Collapse Network Command

The collapse command is a diagnostic function to break the mesh network. All devices will retain the profile information but will be removed from the mesh. The mesh can be reformed by activating mesh formation.



CAUTION: FIRE PROTECTION DISABLED
FIRE PROTECTION FROM WIRELESS DEVICES IS DISABLED WHEN A COLLAPSE NETWORK COMMAND IS ISSUED.

The mesh network can be collapsed using SWIFT Tools. .

Collapse Mesh Network Using SWIFT Tools

To collapse the mesh network using the SWIFT Tools:

- Connect the W-USB dongle device to your computer. For more information on the USB dongle, refer to Section 5.
- Launch the SWIFT Tools application. Refer to Appendix A, “SWIFT Tools” for more information on launching the SWIFT Tools application.
- From the Home Screen, select the **Diagnostics** function.
- Select a Gateway from the communicator panel.
- Click **View Mesh**. The mesh is displayed.

- Click **Advanced Functions** on top of the mesh display. A drop-down list is displayed.

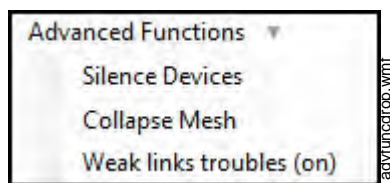

Figure 2.21 Advanced Functions Options

- Click **Collapse Mesh**. The **Collapse mesh network** screen is displayed.



Figure 2.22 Collapse Mesh Network Option

- Click **Yes**. The network is now collapsed and a confirmation message is displayed as shown below.

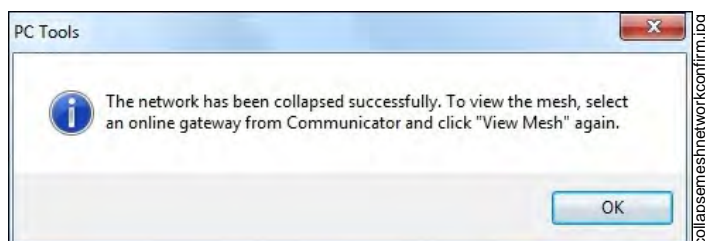

Figure 2.23 Collapse Mesh Network Confirmation

2.9.6 Silence Network Command

The silence network command is a diagnostic function to turn off all radio communication from the wireless devices for a set amount of time. All devices will retain the profile information but will be removed from the mesh. The devices will not send or receive any wireless communication until the set time expires or the device is rebooted. The mesh network can be reformed at the end of the silence period or after the device is restarted.



CAUTION: FIRE PROTECTION DISABLED
FIRE PROTECTION FROM WIRELESS DEVICES WILL BE DISABLED WHEN A SILENCE COMMAND IS ISSUED.

The mesh network can be silenced using SWIFT Tools.

Silence Mesh Network Using SWIFT Tools

To silence the mesh network:

- Connect the W-USB dongle device to your computer. For more information on the USB dongle, refer to Section 5.

2. Launch the SWIFT Tools application. Refer to Appendix A, “SWIFT Tools” for more information.
3. From the Home Screen, select the **Diagnostics** function.
4. Select a Gateway from the communicator panel.
5. Click **View Mesh**. The mesh is displayed.
6. Click **Advanced Functions** on top of the mesh display. A drop-down list is displayed.

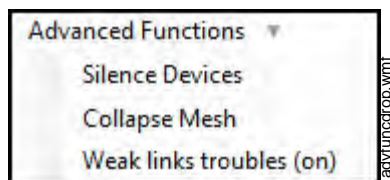

Figure 2.24 Advanced Functions Options

7. Click **Silence Devices**. The **Silence mesh network** screen is displayed.
8. Select the time interval to silence the wireless devices from the dropdown list and click Yes.

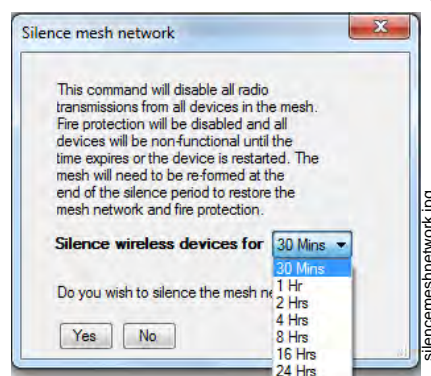

Figure 2.25 Silence Mesh Network Screen

9. Enter the Verification Password in the Gateway Password screen. The network is silenced and confirmation is displayed as shown below.

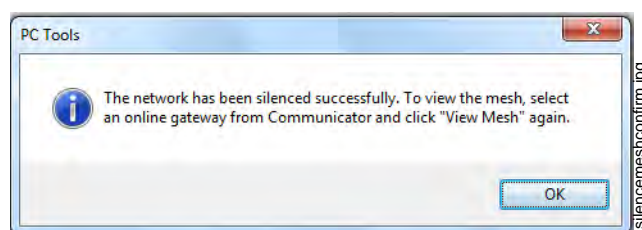

Figure 2.26 Silence Mesh Network Confirmation Message

2.9.7 Multiple Wireless Sensor Network Installation Restrictions

The SWIFT Network technology shares the RF spectrum with other Honeywell Wireless Sensor Network systems. Honeywell has established a limit of 4 overlapping networks to avoid congestion in the RF spectrum. If the 4 network limit is exceeded, a system trouble will be generated by the system that detects 4 or more adjacent networks. To resolve this trouble, the instances of overlap need to be removed. Refer to Appendix C: "Troubleshooting and Testing" for suggestions on removing overlap between wireless networks. The trouble will be self-restoring up to 36 hours after the condition is resolved. To expedite the trouble resolution, toggle the network that is reporting the trouble in and out of mesh formation mode.

2.9.8 Avoiding RF Interference

The SWIFT wireless mesh network uses radio frequency hopping spread spectrum technology to communicate in the 900 MHz ISM band (902MHz to 928MHz). Other commercial and industrial products also operate in this band. If two-way radios or other wireless communication devices are used during the installation process, it is recommended that they be kept at least 4 feet away from the Fire•Lite wireless devices or that they operate on a different frequency band to ensure rapid mesh formation.

A properly installed SWIFT wireless mesh network with primary link reporting enabled will be highly immune to RF interference from other wireless products even when they are nearby. The use of the weak link reporting feature is highly recommended. If the system is installed in a controlled environment where other 900 MHz ISM band devices will not be present, the primary link reporting feature may be disabled to permit greater distances between installed devices if required.

The SWIFT wireless mesh network will be able to automatically detect and avoid certain types of in-band channel interference (often caused by two-way radios) by using an alternate channel set. The system will log detection and avoidance of this kind of interference in the W-GATE history as "Walkie Talkie Mode" Entry or Exit.

Section 3: W-DIS-D Wireless Display Driver

The SWIFT Wireless Sensor Network includes a W-DIS-D (Wireless Display Driver). The W-DIS-D and an ANN-80W are required for the display of wireless-specific events. This section describes the wireless user interface display driver and how it is connected to the ANN-80W. In addition, this section provides information on how to install, configure and monitor the messages on the ANN-80W.

3.1 Description

The W-DIS-D and ANN-80W are required for the display of wireless-specific events.

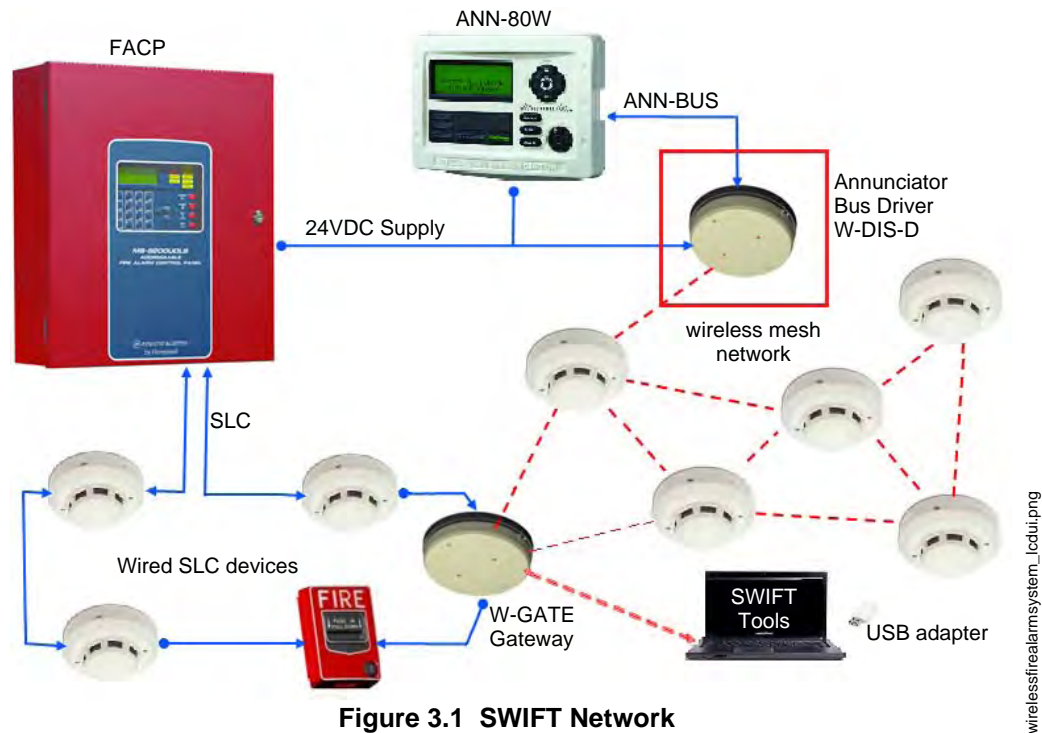

The W-DIS-D is a part of the wireless network and has a specific SLC module address. The W-DIS-D and ANN-80W display the wireless specific events that cannot be displayed on the FACP. These wireless events are related to the trouble and supervisory conditions that are specific to the W-GATE and its devices. The wireless events are indicated at the FACP as a generic trouble or as a supervisory event via the W-GATE using the base address +1 and the base address +2 for supervisory and trouble events respectively. The specific event details are sent to the ANN-80W via the ANN-BUS from the W-DIS-D. The following conditions lead to the trouble and supervisory events.

Trouble Events

- Jamming (device communication loss due to RF interference)
- Duplicate address
- Battery low
- Class A missing second link
- Weak link low signal strength
- Mesh Restructuring
- Wireless mesh formation in progress
- RF comm loss
- Illegal address

- Maximum Gateway
- Maximum devices
- RF Device No Answer

Supervisory Event

- Tamper

3.2 Agency Approvals

3.2.1 FCC

This device complies with part 15 of the FCC Rules. Operation is subject to the following two conditions:

1. This device may not cause harmful interference, and
2. This device must accept any interference received, including interference that may cause undesired operation.

FCC ID: PV3WFSLCDUI

3.3 Specifications

Following are the specifications for the W-DIS-D.

Specifications	Data
Operating Voltage Range	18VDC to 30VDC
Maximum current draw	30 mA
ANN-BUS	Driver: 1.5V - 3.4V and 60 mA max. Receiver: 0.2V - 6V
Radio Frequency	Lower ISM band (915 MHz)
Maximum power output	+17 dBm
Minimum signal strength level needed at the receiver for a primary path with weak link reporting enabled	-50 dBm
Minimum signal strength level needed at the receiver for a secondary path (minimum signal to noise point) or a primary path with weak link trouble reporting disabled	Must be 18 dBm higher than the noise floor down to -80 dBm



NOTE: All connections are power limited.

3.3.1 Environmental Specifications

System	Operating Temperature	Storage Temperature	Humidity
W-DIS-D	0°C-49°C / 32°F-120°F	-10°C-50°C / 14°F-120°F	10 to 93% RH Non-condensing

For information on the , refer to the *ANN-80 Series Installation Document*.

3.4 Magnetic Sensors

The W-DIS-D has two magnetic sensors. The sensors are used to remove a profile as described in Section 3.7.3 or to request a profile as described in Section 3.7.1.

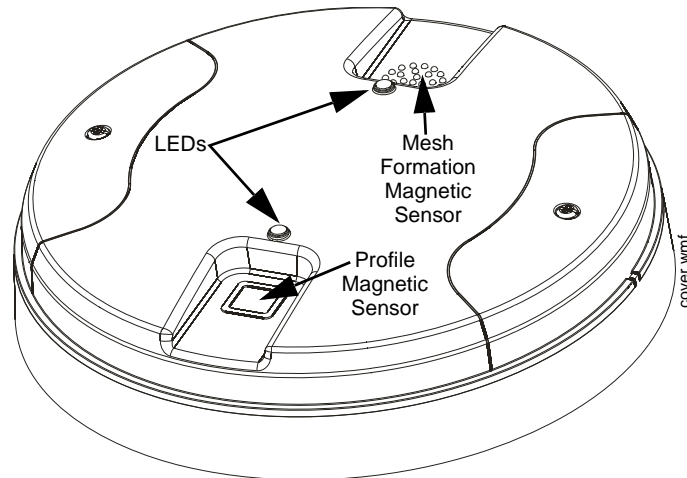

Figure 3.2 LEDs and Magnetic Sensors on W-DIS-D

3.5 W-DIS-D LED Indicators

The two LEDs on the devices blink in the same pattern to allow the LED to be viewed from any angle. The LED patterns are provided in Appendix D.

3.6 Mounting & Wiring

3.6.1 Mounting



WARNING: FORMEX SHEET

ENSURE THAT THE FORMEX SHEET INSIDE THE W-DIS-D IS NOT REMOVED OR TAMPERED WHILE INSTALLING OR CLEANING.

The W-DIS-D has two major pieces, the cover and the mounting plate. The mounting plate is mounted to the wall or ceiling and field wiring is connected to it. The cover contains the PC board and is fastened to the mounting plate once the wiring is connected.

Mount the mounting plate directly to an electrical box on the ceiling or wall. The plate mounts directly to a 4" square (with and without plaster ring), 4" octagon, 3 1/2" octagon, single gang or double gang junction boxes. If an electrical box is not available, the mounting plate can be mounted to any flat surface and the wiring can be connected via the knockout points in the mounting plate.

To mount the W-DIS-D:

1. Pull the wiring through the opening in the mounting plate.
2. Mount the mounting plate to the junction box or ceiling. See Figure 3.3 below.
3. Connect field wiring to the terminals, as described in Section 3.6.2.
4. Connect necessary jumpers where applicable. Refer to Section 2.7.3.
5. To mount the cover, align the locating pins on the cover to the corresponding slots in the mounting plate. See Figure 3.4.
6. Secure the cover by tightening the mounting screws.

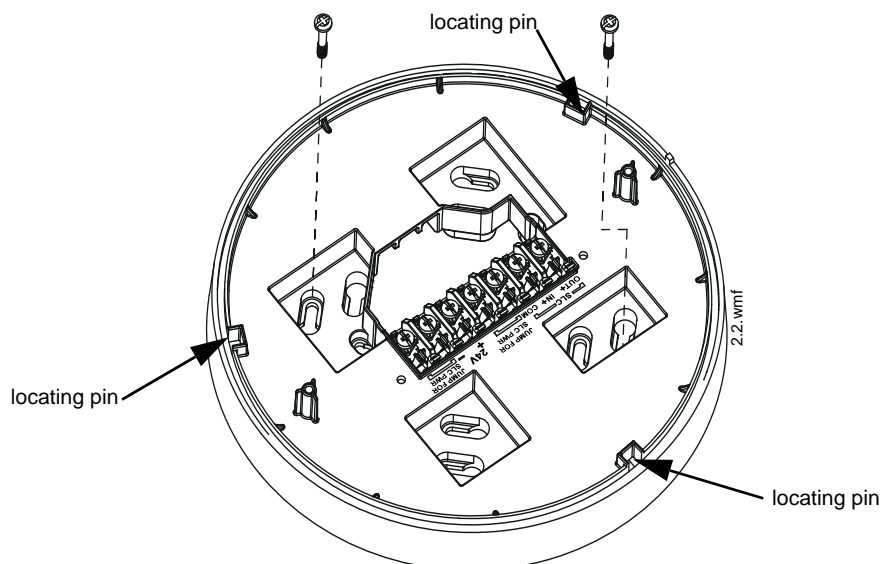

Figure 3.3 Mounting Plate for Wireless Display Driver

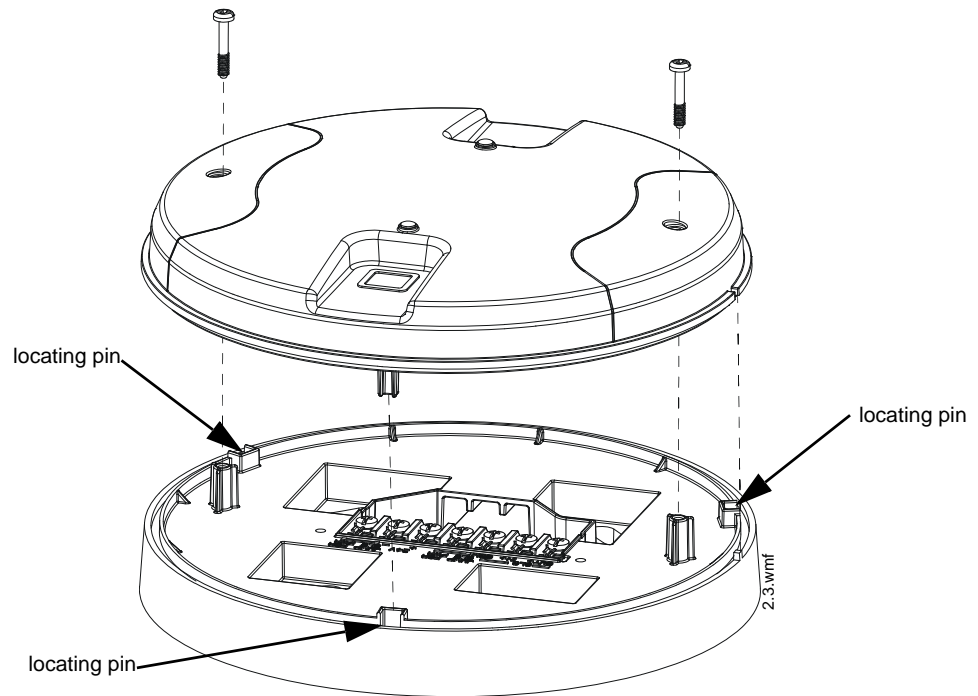

Figure 3.4 Attaching Cover to Mounting Plate

3.6.2 Wiring

- All wiring must be installed in compliance with the National Electrical Code and the local codes having jurisdiction.
- 12-18 AWG is recommended.
- Maximum wiring distance is 6,000 ft. (1,829 m).

For wiring connections:

1. Strip about 3/8” of insulation from the end of the wire.
2. Slide the stripped end of the wire under the appropriate terminal and tighten the screw.



NOTE: Do not loop the wire under the screw terminals.

The ANN-80W and W-DIS-D require regulated +24VDC power supplied by either the host FACP or by a remote power supply. Connect the W-DIS-D to the ANN-80W as described in the table and graphic below

W-DIS-D Terminals	Series Terminals (TB1)
External power ground	Terminal 1 (-)
External power +24VDC	Terminal 2 (+)
A (ANN-BUS)	Terminal 3 (A)
B (ANN-BUS)	Terminal 4 (B)

Table 3.1 Wiring the W-DIS-D to the ANN-80W Series

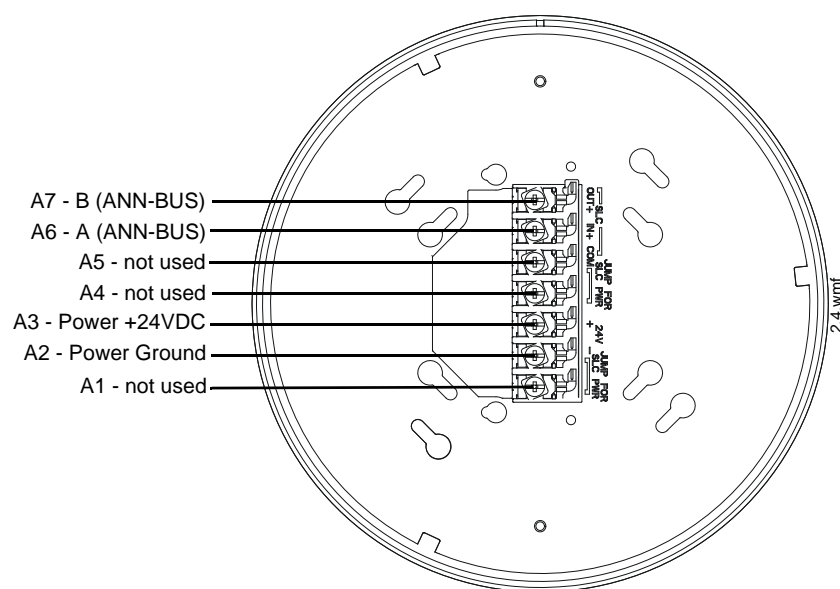

Figure 3.5 W-DIS-D Mounting Plate - Terminal Layout

3.7 Configuration

The configuration of a W-DIS-D starts with assigning a profile. There are two ways to assign a profile.

- Assign a profile to a W-DIS-D with a W-GATE or Distributor
- Assign profiles using SWIFT Tools



NOTE: To assign a profile, the W-DIS-D must be in a factory default state. This is confirmed by a single red light that flashes on the LED. To restore the W-DIS-D to factory default state, refer to Section 3.7.3.

3.7.1 Assign a Profile

Assigning a Profile Without Using SWIFT Tools

A W-GATE that has a profile can be used to distribute the profile to a W-DIS-D. The W-GATE must first be in distribution mode. A device that has a profile can be used to distribute the profile by using distributor mode.

To distribute a profile from W-GATE/distributor to a W-DIS-D:

1. Ensure that the W-GATE or other mesh device with the profile is set for distribution. Refer to Section 2.8.3, “Profile Distribution” or Section 4.5.2, “Distributor Mode”.
2. Power on the W-DIS-D and ensure it is in the factory default state. A single red blink of the LED confirms that the W-DIS-D is in the factory default state.
3. Bring the W-DIS-D within 20 feet (6 m) of the W-GATE or the distributor device.
4. Use a magnet to activate either of the magnetic sensors. The LED will blink a single red every half-second indicating that it is searching for a profile.

Once a magnet sensor is activated, the LED blinks red every half second indicating that it is requesting a profile. If the profile is successfully received, the green LED turns on steady for 10 seconds. If the profile is not received within one minute, the LED blinks red every ten seconds indicating that it has stopped requesting a profile.

Assign a Profile Using SWIFT Tools

To assign a profile to the W-DIS-D using SWIFT Tools:

1. Connect the W-USB dongle device to your laptop. For more information on the USB dongle, refer to Section 5, “USB Adapter”.
2. Launch SWIFT Tools. Refer to Appendix A for more information.
3. From the Options Screen, select the **Create Mesh Network** function.
4. **Create** a new profile or **Import** an existing profile as required.
5. Select and open the profile to be assigned to the W-DIS-D from the Name drop-down box in the Profile section.

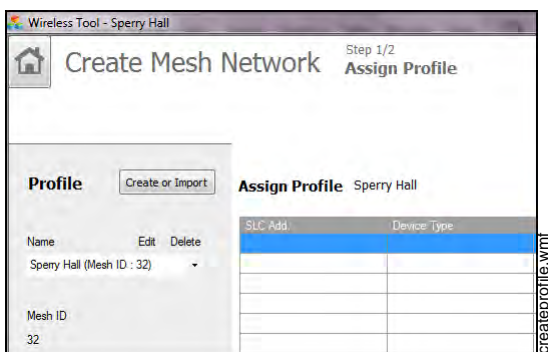

Figure 3.6 Creating or Importing a Profile

6. Power on the W-DIS-D within approximately 20 feet of the laptop running SWIFT Tools.
7. Ensure that the **Scan On** selection box in the **Communicator Window** is checked.
8. Select the W-DIS-D from the **Communicator Window**. The W-DIS-D is listed by its generic name, “LCD UI”.

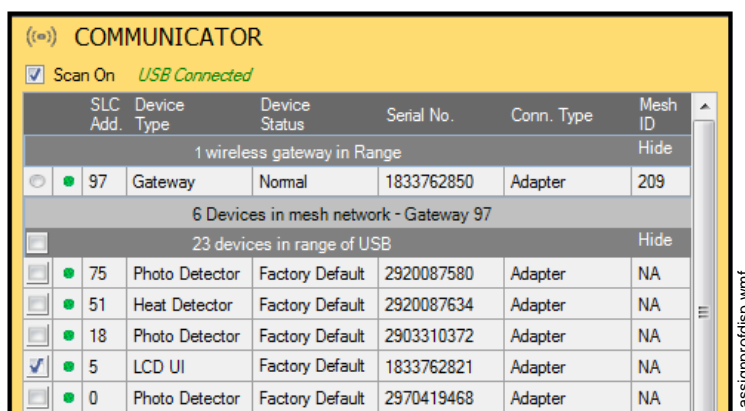

Figure 3.7 Selecting the Display Driver

9. Click **Assign**.

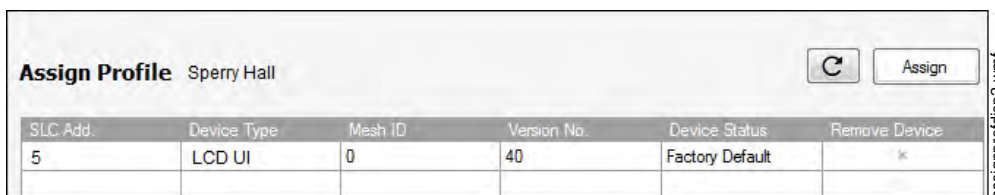

Figure 3.8 Assigning a Profile

The W-DIS-D is now included in the list of devices with a profile assigned. The LEDs on the W-DIS-D will turn on green for 10 seconds after the profile has been received.

3.7.2 Mesh Formation

To add a W-DIS-D to a mesh, refer to “Create a Mesh Network” on page 21 or “Mesh Formation” on page 23.

3.7.3 Removing Profiles

Restoring to Factory Default Without Using SWIFT Tools

To remove a profile without using SWIFT Tools:

1. Start with the device powered off. The process is performed during start-up.
2. Power on the W-DIS-D using regulated, external +24V.
3. Verify the W-DIS-D is in the profile modification state. Both the LEDs on the W-DIS-D double blink yellow every second for ten seconds in the profile modification state.
4. Activate both the magnetic sensors within ten seconds of starting up the W-DIS-D while the double yellow blink is active in the W-DIS-D. If the ten second window is missed, power down the W-DIS-D and repeat the process starting at step 1.
5. The LEDs on the W-DIS-D will blink green every second for five seconds indicating that the profile is removed.

After following the above steps, the profile is erased and the W-DIS-D returns to factory default state.

Restoring to Factory Default Using SWIFT Tools

To remove a profile using SWIFT Tools:

1. Connect the W-USB dongle device to your laptop. For more information on the USB dongle, refer to Section 5.
2. Launch SWIFT Tools. Refer to Appendix A for information.
3. From the options menu, select the **Site Survey**, **Create Mesh Network**, or **Diagnostics** function.
4. Click **Extras** and select **Set device to factory default**.

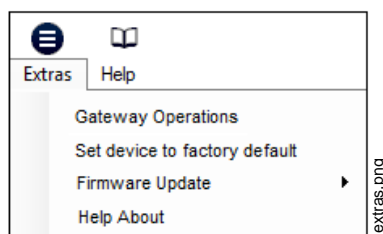

Figure 3.9 Extras Menu

- The **Reset Devices** screen appears, displaying the W-DIS-D and other devices that have a profile assigned. Click to select the required device and click **Reset Device** to remove the profile.

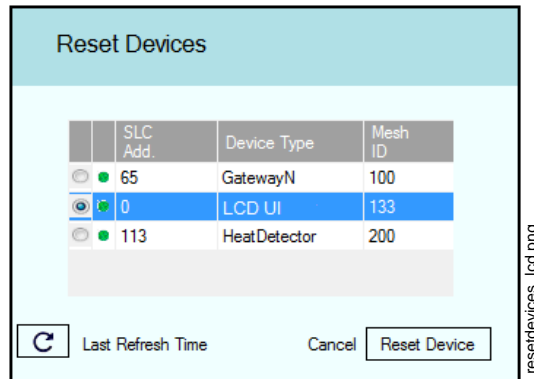

Figure 3.10 Reset Devices Menu

The profile is removed and the device is reset to the factory default state.

3.8 ANN-80W Configuration

To configure the ANN-80W, set the dip switch address on the ANN-80W to 1 when it is connected to the W-DIS-D. For more information on setting addresses on the ANN-80W, refer to the *ANN-80 Series Product Installation Document*.

3.9 W-DIS-D Operations

Table 3.2 outlines the wireless related events and the description at each display.

Events	FACP Displays:	Annunciator Displays:
Alarm (Detector or Module activations)	Address specific to the initiating device.	No Display
Tamper	Generic Supervisory at GW +1 address	Specific device with SLC address
RF related trouble conditions - Jamming, Battery Low, Duplicate address, Class-A missing second link, Weak link low signal strength.	Generic Trouble GW +2 address	Specific device with SLC address
Wireless Device Missing from network	No Answer/Invalid response for the specific SLC Address	"RF Device No Answer" (no address specified)
W-GATE initializing, wireless mesh formation in progress.	Generic Trouble GW +2 address	"Gateway Initialization" (no address specified)
Illegal address	Generic Trouble GW +2 address	Address zero
Mesh capacity exceeded	Generic Trouble GW +2 address	W-GATE base address
RF comm loss	"No Answer" / "Invalid response" for the W-DIS-D SLC Address	"RF Comm Loss"
Annunciator lost connection	Open circuit at W-DIS-D SLC Address	"Key Bus Trouble"
Normal	No Display	Mesh ID number

Table 3.2 Event Display Location Table



NOTE: One W-DIS-D is required for one W-GATE. Multiple W-GATE installations require a W-DIS-D for each W-GATE.

3.9.1 Modes of Operation Not in a Mesh Network

Bootloader

In this mode, the W-DIS-D cannot participate in a mesh and cannot provide fire protection. The W-DIS-D will be available in the communicator window of SWIFT Tools with a status “Bootloader”. To get a device out of bootloader, refer to Section C.1, “Troubleshooting”.

Factory Default

In this mode, the W-DIS-D is not associated with the W-GATE. For further information on assigning a profile, refer to Section 3.7.1. In this mode, the W-DIS-D will be viewable in the communicator window of SWIFT Tools with a state of “Factory Default”. The ANN-80W will display RF COMM LOSS when the W-DIS-D is at Factory Default state.

Profile Configured

In this mode, the W-DIS-D is associated with the W-GATE but is not an active participant in the mesh network. For further information on mesh formation, refer to, “4.5.3, “Mesh Formation”. To remove a profile from a W-DIS-D, refer to section, “3.7.3, “Removing Profiles”. In this mode, the W-DIS-D will be viewable in the communicator window of SWIFT Tools with a state of “Active Scan”. The ANN-80W will display RF COMM LOSS when the W-DIS-D is at factory default state.

3.9.2 Modes of Operation as a Mesh Participant

Mesh Formation Mode

In this mode, the W-DIS-D is an active participant in a mesh that is forming. The LED will blink green then blink yellow every 7 seconds. For further information on mesh formation mode, refer to, “4.5.3, “Mesh Formation”. The W-DIS-D will not communicate directly with SWIFT Tools for display in the communicator. The status of the W-DIS-D must be obtained via the W-GATE. The ANN-80W will display ‘Mesh Formation in Progress’ during mesh formation mode.

Initial Mesh Restructuring Mode

In this mode, the mesh network is formed and is in the process of establishing stronger communication paths. The LED will blink yellow every 7 seconds. For further information on initial mesh restructuring mode, refer to the topic, “Initial Mesh Restructuring Mode”. The W-DIS-D will not communicate directly with SWIFT Tools for display in the communicator. The status of the W-DIS-D must be obtained via the W-GATE. The ANN-80W will display Gateway Initializing during the initial mesh restructuring mode.

Normal Mode

In this mode, the mesh network formation is complete. The LED will blink green every 14 seconds. If a device is in trouble, it will be displayed at the ANN-80W or the FACP. For information, refer to Section 3.10.3, “Event Messages”. The W-DIS-D will not communicate directly with SWIFT Tools for display in the communicator. The status of the W-DIS-D must be obtained via the W-GATE. The ANN-80W will display the mesh ID when the system is normal, or will display a wireless event as specified in Section 3.10.3, “Event Messages”.

Rescue Mode

In this mode, devices that are active participants in the mesh search and retrieve the devices that have lost the communication link. The rescue mode is indicated by the a green blink every 7 seconds. For more information on rescue mode refer to “Section 2.9.1, “Modes of Operation” The W-DIS-D will not communicate directly with the SWIFT Tools for display in the communicator. The status of the W-DIS-D must be obtained via the W-GATE. The ANN-80W will display the mesh ID when the system is normal, or will display a wireless event as specified in 3.10.3, “Event Messages”.

3.9.3 SLC Operation

Program the SLC point on the W-DIS-D as a monitor point. When the communication to the ANN-80W is missing or disrupted, the SLC point will indicate an open circuit but will not initiate an alarm condition. Refer to Figure 2.14 on page 22 for instructions on setting the address wheels.

3.9.4 LED Patterns

The LED indicator patterns are provided in Appendix D on page 69.

3.10 ANN-80W Operations

The ANN-80W displays wireless-specific events for the associated mesh network. Alarm conditions and trouble events that are displayed by the FACP are not displayed at the ANN-80W. The ANN-80W incorporates an automatic resound of the piezo and trouble indicator every 4 hours for active events.

3.10.1 Annunciator Control Buttons and Visual Indicators

When used as part of a wireless network with the W-DIS-D, use of the buttons and indicators on the ANN-80W differs from regular annunciator function. The button and indicator functions are displayed below and are explained in Tables 3.3 and 3.4.

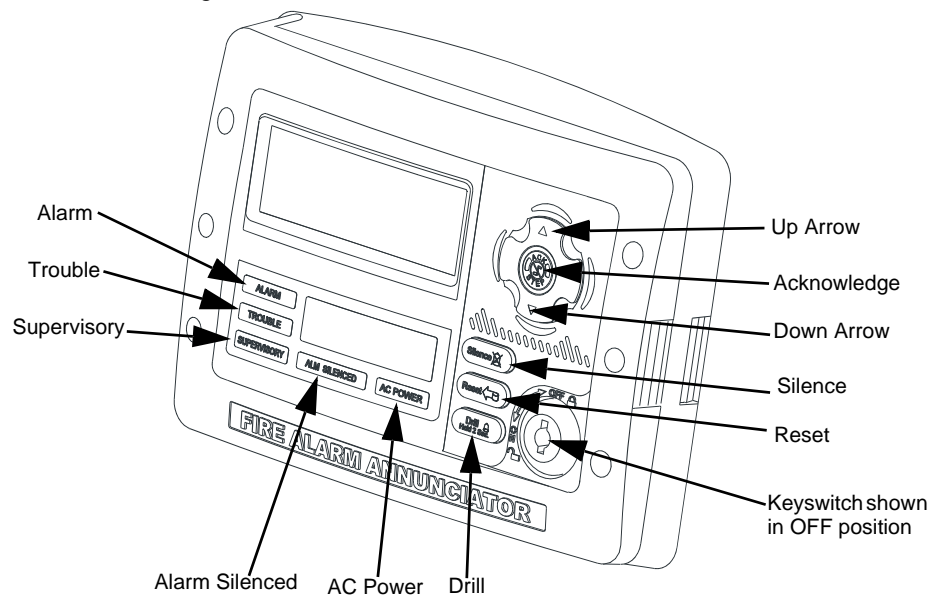

ann-80_iso2.wmf

Figure 3.11 Buttons and Indicators on the ANN-80W

Button	Action
Up Arrow	Press the UP Arrow to scroll up through the messages.
Acknowledge button	Press the ACK button to acknowledge the messages and silence the piezo.
Down Arrow	Press the Down Arrow to scroll down through the messages.
Silence button	Not Used
Reset button	Press the Reset button to clear latching wireless events.
Keyswitch	Use the Keyswitch to enable the Reset button.

Table 3.3 ANN-80W Button Functions

Button	Action
Drill button	Not Used

Table 3.3 ANN-80W Button Functions

Indicator	Action
Alarm	Not Used
Trouble	The trouble LED blinks yellow for any unacknowledged trouble event and it turns on steady for acknowledged trouble events
Supervisory	The Supervisory LED blinks yellow for any unacknowledged tamper event, and it turns on steady for acknowledged tamper events
Alarm Silenced	Not Used
AC Power	Not used

Table 3.4 ANN-80W Visual Indicators

3.10.2 Audible Indicators

Wireless events are sent to the FACP as generic trouble or supervisory events by the W-GATE. Details of those specific events are sent to the ANN-80W by the W-DIS-D. The FACP piezo activates for the first trouble event and the first supervisory event. The FACP piezo will not activate for additional trouble or supervisory events when the initial event is still active. The ANN-80W piezo will not activate for the first event but will sound for each event after the first event.

Press the ACK button to acknowledge the event and silence the piezo. The reset function can be enabled in the ANN-80W using the keyswitch. To enable the reset button, insert the key into the keyswitch and turn the keyswitch counterclockwise to the **ON** position.

3.10.3 Event Messages

Wireless network event messages are displayed on the FACP and . These messages are displayed based on their occurrences. Use the up arrow and down arrow buttons to scroll through the messages. Trouble and supervisory events that are specific to a device will specify the device address on the . The FACP will display a trouble condition for the gateway +2 address for *any* wireless trouble. The FACP will indicate an activation for the gateway +1 address for *any* tamper event.

RF Comm Loss

RF COMM LOSS is displayed when the W-DIS-D is not in the network. This message is displayed if the W-DIS-D is in bootloader, factory default, or profile assigned mode but not a part of a mesh network. **RF COMM LOSS** is a non-latching event that will clear once the W-DIS-D joins a mesh network.

Trouble Wireless Mesh Formation In Progress

MESH FORMATION IN PROGRESS is displayed when the network is in mesh formation mode. **MESH FORMATION IN PROGRESS** is a non-latching trouble event that will clear once the W-GATE exits mesh formation mode. The must join the network to show this message. If the is not present in the network, **RF COMM LOSS** is displayed.

Low Battery Event

TROUBLE BATTERY LOW is displayed if:

- a device has a minimum of one week power left to perform the required operations.

Or

- there are less than 4 viable batteries installed.

The low battery event is a latching condition. To clear the low battery event, tamper the device and replace all four batteries. When a device is tampered, it drops out of the mesh network and attempts to rejoin as soon as the batteries are replaced and the tamper event is cleared. The wireless device and its address are displayed as a trouble on the ANN-80W and generic trouble on the FACP. Initiate a RESET at the ANN-80W to clear the low battery event.

Trouble Jamming Event

TROUBLE JAMMING displays when a device is overloaded with an interfering RF signal but is able to send outgoing messages. A jamming event is detected after 20 seconds of exposure to the jamming signal. The jamming event is displayed as a trouble event in the ANN-80W and generic trouble event on the FACP. Jamming is a non-latching trouble. To clear the jamming trouble, remove any interference sources near the point that is reporting the trouble. For more information, refer to Appendix C.

Trouble Duplicate Address

Two wireless devices on the same mesh network that are set to the same address report a **TROUBLE DUPLICATE ADDRESS**. A duplicate address is a non-latching trouble that will correct itself once the conflict has been resolved.

Trouble Class A Missing 2nd Link

The **TROUBLE CLASS A** message denotes a single connection path from the device. The wireless system is a class A system requiring two communication paths for normal operations. To remedy the class A fault, ensure adequate device spacing or the use of a repeater may be required. The wireless mesh is a self-healing network. If the trouble is not cleared within 5 minutes, additional actions may be required. Refer to the troubleshooting section for tips on resolving class A fault conditions.

Trouble Wireless Gateway Initializing

The ANN-80W displays **GATEWAY INITIALIZATION** when it is restructuring for the first time. Gateway initializing is a non-latching trouble that is active during the first mesh restructuring. The message will clear once the first mesh restructuring routine finishes.

System Normal

The ANN-80W displays **WIRELESS GW DISPLAY** and the mesh ID number when the system is functioning normally and there are no wireless troubles in the system.

Supervisory Tamper

SUPERVISORY TAMPER indicates that a detector is not firmly attached to its base or the cover plate is not properly attached to a module. The Tamper events are displayed as supervisory events on the ANN-80W, using the device address, and generic supervisory events on the FACP, using Base +2 of the gateway address. Tamper is a latching condition that requires a reset at the ANN-80W to clear.

Trouble Weak Link Low Signal Strength

TROUBLE WEAK LINK indicates insufficient signal strength. To resolve a weak link, ensure there is adequate device spacing. The use of a repeater may be required. Tamper any devices when moving them to a new location. Restart mesh formation once the repeater is installed or devices rejoin the network, after the tamper is cleared. The W-GATE will re-evaluate the signal strength connectivity with the neighboring devices and select suitable signal paths during the subsequent mesh restructuring.

Key Bus Trouble

A **KEY BUS TROUBLE** indicates that the ANN-80W has lost connection with the W-DIS-D.

Capacity Exceeded

CAPACITY EXCEEDED indicates that there are already fifty devices present in the mesh and one more device is trying to join the network.

Maximum Gateways

MAXIMUM GATEWAYS EXCEEDED indicates that the number of overlapping gateways exceeds the limit of 4. The trouble will be cleared only when the number of overlapping gateways is reduced to 4 or less. Refer to Appendix C for more information.

RF Device No Answer

RF Device No Answer is a generic trouble event to indicate one or more wireless devices currently or previously have lost communication with the mesh network. RF Device No Answer is a latching event that requires a reset at the ANN-80W. RF Device No Answer will be indicated 180 seconds after a device has lost communication with the mesh network. The device may have lost communication due to a tamper event, dead battery, jamming, or device drop (complete loss of communication).

3.10.4 Clearing messages

The events that are non-latching will clear once the event returns to the normal state. Events that are latching require a reset at the ANN-80W. To reset messages, press the **Reset** button on the ANN-80. Refer to Figure 3.2. To reset messages at the panel, initiate a system reset.

Section 4: Wireless Devices

4.1 Description

The SWIFT Network consists of the following devices:

W-SD355 - Wireless Photoelectric Smoke Detector -FCC ID: AUBWFSSD

The wireless photoelectric smoke detector is powered by four CR123A batteries. It has a sensor head to detect smoke and LEDs to indicate the activation and trouble status.

W-SD355T- Wireless Photo/Heat Detector FCC ID: AUBWFSSD

The wireless photo/heat detector is powered by four CR123A batteries. It has a sensor head to detect heat and LEDs to indicate activation and trouble status.

W-H355R- Wireless Rate of Rise Heat Detector FCC ID: AUBWFSSD

The rate of rise heat detectors are powered by four CR123A batteries. The detectors have LEDs to indicate the activation and trouble status.

W-H355- Wireless 135° Fixed Heat Detector FCC ID: AUBWFSSD

The fixed heat detectors are powered by four CR123A batteries. The detectors have LEDs to indicate the activation and trouble status.

W-MMF- Wireless Addressable Monitor Module FCC ID: AUBWFSSMM

The wireless monitor module is powered by four CR123A batteries. It can be connected to a switch within three feet of its location or wired directly to the pull station. The module has LEDs to indicate the activation and trouble status.

For more information on the LED indicators, refer to Section 4.6.2.

4.2 Agency Approvals

4.2.1 FCC

This device complies with part 15 of the FCC Rules. Operation is subject to the following two conditions:

1. This device may not cause harmful interference.
2. This device must accept any interference received, including interference that may cause undesired operation.



**WARNING: DO NOT MAKE CHANGES TO THE EQUIPMENT.
CHANGES OR MODIFICATIONS NOT EXPRESSLY APPROVED BY THE MANUFACTURER
COULD VOID THE USER'S AUTHORITY TO OPERATE THE EQUIPMENT.**

4.3 Specifications

The following are the specifications for the wireless devices.

Specification	Data
Radio Frequency	Lower ISM Band (902-928 MHz)
Maximum power output	+17dBm
Minimum signal strength level needed at the receiver for a primary path with weak link trouble reporting enabled.	-50dBm
Minimum signal strength level needed at the receiver for a secondary path or primary path with weak link trouble reporting disabled.	Must be 18 dBm higher than the noise floor down to -80dBm
Maximum ambient noise level	-85dBm
Minimum battery life	1 year

Table 4.1 Wireless Device Specifications

4.4 Installing, Mounting, and Wiring Devices

For information on installing the wireless devices, refer to the documents referenced in Table 1.1.

4.5 Configuration and Programming

Device configuration starts with assigning a profile.

4.5.1 Assigning Profiles

To assign a profile, the device must be in a factory default state. A single red light flashes on the LED confirming that the device is in the default state. To restore the device to factory default state, refer to Section 4.5.4, “Restoring a Device to Factory Default”.

There are two methods to assigning a profile.

Assigning a Profile to a Device (Detector or Module) Using a W-GATE or Distributor

A W-GATE that has a profile can be used to distribute that profile to other devices. The W-GATE must be in distributor mode before it can distribute a profile. For more information on converting a W-GATE to a distributor, refer to Section 2.8.3. A device with a profile can be used to distribute the profile. To put a device into distributor mode, refer to topic, “Converting a Device into a Distributor” on page 49.

■ Distribute a Profile from W-GATE/Distributor to a Detector

To transfer a profile from W-GATE/distributor to a detector:

1. Bring the detector within 20 feet of the W-GATE/distributor.
2. Power on the detector. Ensure the detector is in factory default state. The LED on the detector will single-blink or double-blink red confirming that it is in the factory default state.

3. Activate the magnet test switch shown in the figure below. Once the magnet sensor has been activated, the LED blinks red every half second indicating that it is requesting a profile. If the profile is successfully received, the green LED turns on steady for 10 seconds. If the profile is not received within 1 minute, the LED blinks red every ten seconds indicating that it has stopped requesting a profile.

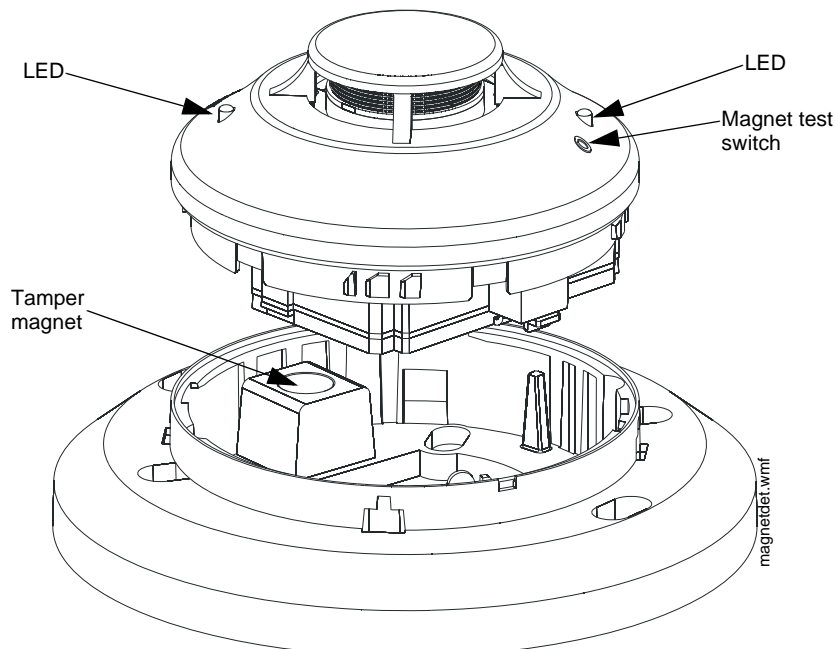

Figure 4.1 Magnetic Sensor on a Detector

■ Distribute a Profile from W-GATE/Distributor to a Module

To transfer a profile from W-GATE/distributor to a module:

1. Bring the detector within 20 feet of the W-GATE/distributor.
2. Power on the module. Ensure the module is in factory default state. If the module is in factory default state, the LED blinks red once.
3. Toggle the state of the tamper condition to instruct the module to request a profile. To toggle the tamper condition state, start with the faceplate removed.
4. Quickly replace then remove the faceplate from the module. Do not attach the mounting screws for the faceplate during this step. The LED blinks red every half second indicating that it is requesting a profile. The green LEDs turn on steady for ten seconds indicating that the profile has been assigned. If the profile is not received within 1 minute, the LED blinks red every ten seconds indicating that it has stopped requesting a profile.

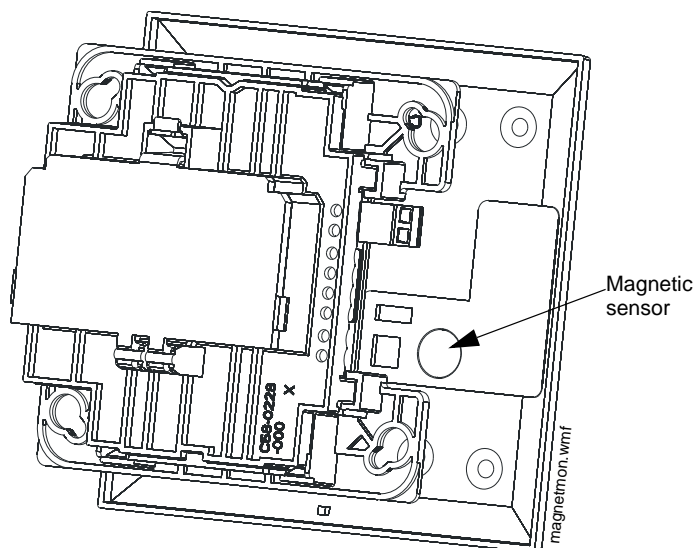

Figure 4.2 Magnetic Sensor on a Module

Assigning a Profile Using SWIFT Tools

To assign a profile to the device using the SWIFT Tools application, do the following:

1. Connect the W-USB dongle device to your computer. For more information on the USB dongle, refer to Section 5.
2. Launch the SWIFT Tools application. Refer to Appendix A, “SWIFT Tools” for more information.
3. From the Home Screen, select the **Create Mesh Network** function.
4. Create a new profile or import an existing profile as required.
5. Select and open the profile to be assigned to the W-GATE from the Name drop-down box in the Profile section.

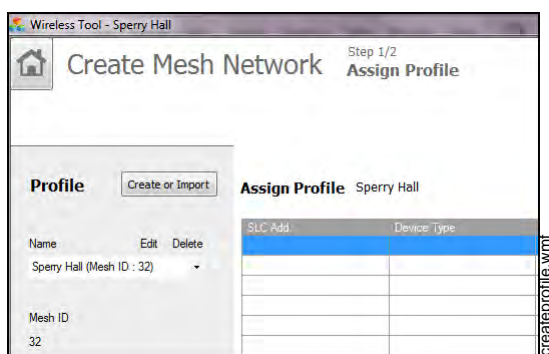

Figure 4.3 Creating or Importing a Profile

6. Power on the device within approximately 20 feet of the laptop running SWIFT Tools.
7. Ensure that the **Scan On** selection box is checked.

- Select the device from the **Communicator** panel.

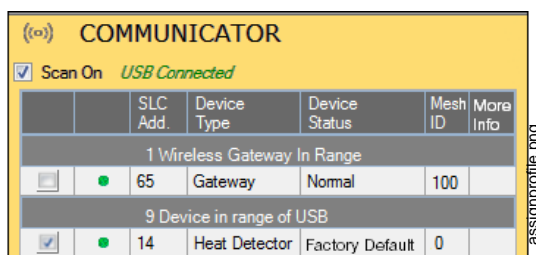

Figure 4.4 Selecting a Device

- Click **Assign**.

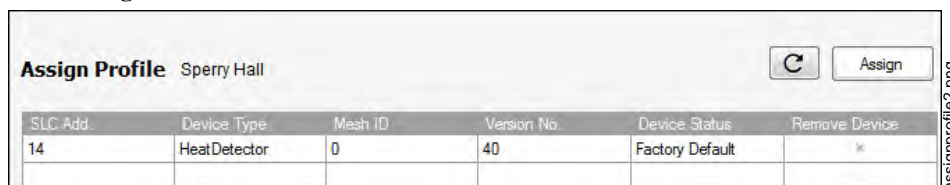

Figure 4.5 Assigning a Profile

The device is now included in the list of devices with a profile assigned. When the profile is assigned, the green LEDs turn on steady for 10 seconds.

4.5.2 Distributor Mode

Converting a Device into a Distributor



NOTE: Only a device with a profile can be used as a distributor.

To turn a device into a distributor:

- Power up the device with one battery installed.
- Ensure that the device is in the profile modification mode. If the device is in profile modification mode, the yellow LED will blink once every 5 seconds. The profile modification mode times out if the device has not received a command in one minute.
- Toggle the SLC address wheel between 0-1-0-1. To toggle the SLC address wheel, use a common screwdriver to adjust the rotary switches on the device to:
 - Set the address to 0.
 - Change the address to 1.
 - Change the address back to 0.
 - Change the address back to 1.



NOTE: The green LED blinks every half second when the device is functioning as a distributor.

Converting a Distributor Back into a Device

To return a distributor device back to a network device, replace the batteries and provide a proper SLC address. A normal device requires four batteries for proper operation. It is recommended to use fresh batteries after the distributor mode.

4.5.3 Mesh Formation

To add a device to a mesh, refer to the topic, "Create a Mesh Network". To form a mesh network, ensure that the W-GATE is powered on and contains a profile. Activate the mesh formation (refer to Figure 2.2) magnetic sensor on the W-GATE.

Repeater

The SWIFT Network does not require the use of a dedicated repeater as all wireless devices act as repeaters. When the repeater function is needed in a location where no specific fire function is required, a wireless monitor module or another device can be installed to act as a repeater.

4.5.4 Restoring a Device to Factory Default

Removing Profiles Without Using SWIFT Tools

A device can be restored to factory default state:

1. Start with the device powered off. The process is performed during start-up.
2. Power on the device by inserting a single battery into any slot in the device. The LEDs will blink yellow twice every five seconds for one minute after inserting the battery.
3. Toggle the SLC address wheel between 0-159-0. To toggle the SLC address wheel, use a common screwdriver to adjust the rotary switches on the device to:
 1. Set the address to 0.
 2. Change the address to 159 (tens set to 15, ones set to 9).
 3. Change the address back to 0.

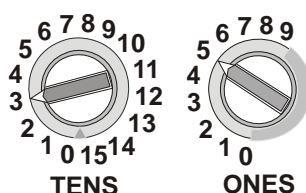

Figure 4.6 Address Rotary Switches

SLC-seraddtph.wmf



NOTE: The above illustration depicts the rotary switches being set at address 35 (rotary switch on 'TENS' set at 3 and rotary switch on 'ONES' set at 5). Ensure that the code wheel address pattern is toggled within 1 minute of inserting the battery.

After the address wheel pattern is set, the LEDs in the device blink green five times followed by a single or double red blink confirming that the device has been reverted back to factory default condition.

Removing a Profile Using SWIFT Tools

To remove a profile in a device using SWIFT Tools:

1. Connect the W-USB dongle device to your computer. For more information on the USB dongle, refer to Section 5.
2. Launch the SWIFT Tools application. Refer to Appendix A, “SWIFT Tools” for more information on launching the SWIFT Tools application.
3. From the Home Screen, select the **Site Survey**, **Create Mesh Network**, or **Diagnostics** function.
4. Click **Extras** and select **Set device to factory default**.

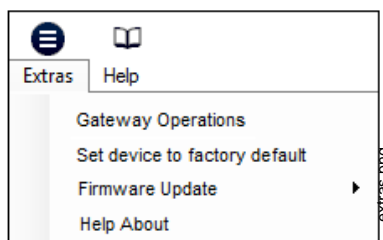

Figure 4.7 Extras Menu

- The **Reset Devices** screen appears, displaying the W-GATE and other devices that have a profile assigned. Click to select the desired device and click **Reset Device** to remove the profile.

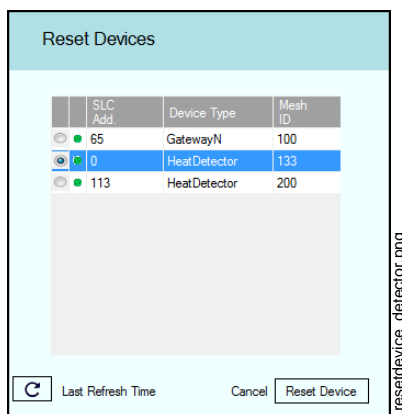

Figure 4.8 Reset Devices Screen

The profile is removed and the device is reset to the factory default state.

4.6 Device Operations

4.6.1 Modes of Operation

Factory Default Mode

In this mode, the devices are not associated with the W-GATE. A profile must be assigned to associate the device with the W-GATE. For further information on assigning a profile, refer to “Assigning a Profile to a Device (Detector or Module) Using a W-GATE or Distributor” on page 46. A device cannot perform any fire protection in the factory default state. In default mode, the devices will be viewable in the communicator window of SWIFT Tools with the state displayed as “Factory Default”. A device in factory default can be used for site survey.

Site Survey Mode

A site survey assesses and qualifies a site for installing a SWIFT network. The site survey view in SWIFT Tools gives the Radio Frequency (RF) assessment of the site. The tool reports the suggested device spacing based on the data collected during the site survey. This helps to improve the reliability and performance of a SWIFT network in the wireless fire alarm system. A device cannot perform any fire protection in the site survey mode. A device that is ready to enter site survey will indicate “pending site survey” in the communicator section of SWIFT Tools. A device in site survey will not communicate with SWIFT Tools and will be listed as “offline” in the communicator section. For more information on performing a site survey, refer to Appendix B.

Profile Assigned Mode

In this mode, devices are associated with the W-GATE but are not active participants in the mesh network. A device that is not in the tampered state can join a mesh network in formation or during rescue mode. For further information on mesh formation, refer to “Mesh Formation Mode” on page 52. For more information on rescue mode, refer to “Rescue Mode” on page 52. A device with an assigned profile can also be used to distribute profiles. Refer to Section 4.5.2.

Devices are not enabled for fire protection until they become part of a mesh network. A device will show an invalid reply or no answer at the FACP.

In this mode, devices are viewable in the communicator window of SWIFT Tools. If the device has a profile and is in the tampered state, it will indicate a status as “Profile Assigned-Tamper”. A non-tampered device will indicate “active scan” as it searches for a mesh network.

Bootloader Mode

In this mode, a device is ready for an update. It cannot participate in a mesh network and cannot provide fire protection. The device is viewable in the communicator window of SWIFT Tools with the status “Bootloader”. To remove a device from bootloader mode, refer to Appendix C.

Distributor Mode

In this mode, a device is functioning as a profile distributor. The device cannot participate in a mesh network and cannot provide fire protection while it is in distributor mode. A device in distributor mode will be used as a mobile unit to share the profile with other devices. The distributing device will be available in the communicator window of the SWIFT Tools with the status "Distributor". For more information, refer to Section 4.5.2.

Mesh Participant Modes

Devices that are in the mesh network no longer communicate directly with SWIFT Tools. SWIFT Tools must communicate with the W-GATE for status information on a device. The W-GATE will respond to the FACP for the device at the address set with the SLC rotary address wheels.

■ Mesh Formation Mode

In this mode, a device is an active participant in a mesh that is forming. The LED will blink green then yellow every 7 seconds. The device cannot perform any fire protection in this state. For further information on mesh formation mode, refer to “Section 4.5.3”.

■ Initial Mesh Restructuring Mode

In this mode, the mesh network is formed and is in the process of establishing stronger communication paths. The LED will blink yellow every 6.8 seconds. The device cannot perform any fire protection in this state.

■ Normal Mode

In normal mode, the mesh network is formed and provides fire protection. The LED will blink green every 14 seconds. The LED flash can be disabled by panel configuration. If a device is in trouble, it is indicated by the trouble messages.

■ Rescue Mode

In rescue mode, a device is an active participant of a mesh network. It will search and retrieve any device that has lost communication with the network. Rescue mode is indicated by a green LED blink every 7 seconds.

4.6.2 LED Indicators

The two LEDs on the devices blink in the same pattern to allow the LEDs to be viewed from any angle. The LED indicators are provided in Appendix D on page 69.

Section 5: USB Adapter

5.1 Introduction

The W-USB is a software interface that can be connected to a PC (running SWIFT Tools) through a USB port. It communicates with the RF devices using the same frequencies as the mesh protocol. This device is powered directly by the USB port.

The LED gives an indication of power and initialization status.

Color	Description
Red	Device has power but is not initialized or the driver is missing.
Yellow	Device is initialized and ready.
Blue	Device is updating or failed to load properly. Complete the update or repower the device. If problems persist, contact technical support.

The W-USB has an adjustable USB connector to facilitate connection by reducing the size when connected to a laptop/tablet.

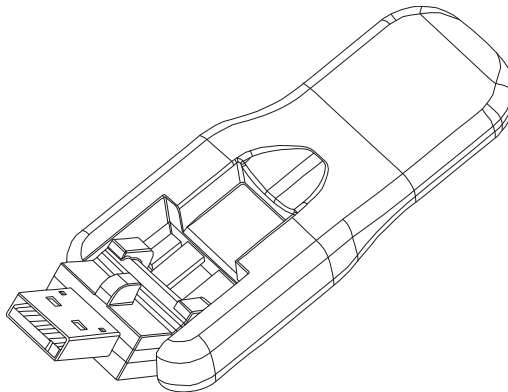

usb.wmf

Figure 5.1 USB Adapter

5.2 Agency Approvals

5.2.1 FCC

This device complies with part 15 of the FCC Rules. Operation is subject to the following two conditions:

1. This device may not cause harmful interference, and
2. This device must accept any interference received, including interference that may cause undesired operation.

FCC ID - PV3WFSADPT



**WARNING: DO NOT MAKE CHANGES TO THE EQUIPMENT.
CHANGES OR MODIFICATIONS NOT EXPRESSLY APPROVED BY THE MANUFACTURER
COULD VOID THE USER'S AUTHORITY TO OPERATE THE EQUIPMENT.**

5.3 Specifications

5.3.1 Electrical Specifications

- Operating voltage: 4.3 VDC - 5.5 VDC (5VDC typical)
- Supply current: 25 mA - 85 mA (33 mA typical)

5.3.2 Serial Communication Specification

- USB standard 2.0

5.3.3 Mechanical Specifications

- USB Connector type A
- Length with connector closed: 3 in. (76.2 mm)
- Length with connector open: 3.8 in. (96.2 mm)
- Thickness on connector side: 0.5 in (13 mm)
- Thickness on antenna side: 0.3 in. (8.4 mm)
- Width: 1.2 in. (31.2 mm)
- Weight: 0.7 oz. (19.5 g)

5.3.4 Environmental Specifications

- Humidity: 10%RH - 93%RH, non-condensing
- Maximum operating temperature: 32°F - 122°F (0°C - 50°C)
- Storage temperature: 14°F - 140°F (-10°C - 60°C)

5.4 Driver Installation



NOTE: Install SWIFT Tools before attempting to install the driver.

To install a driver:

1. Insert the adapter into the PC. The adapter is detected and is displayed in the Computer Management screen as a **Wireless Fire System Dongle**.

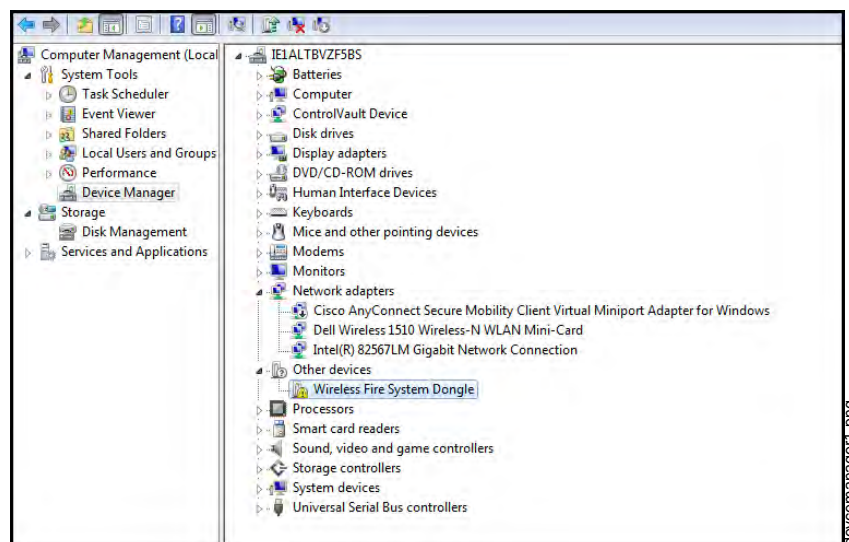

Figure 5.2 Computer Management Screen

2. Right click on **Wireless Fire System Dongle** and select **Update Driver Software**.

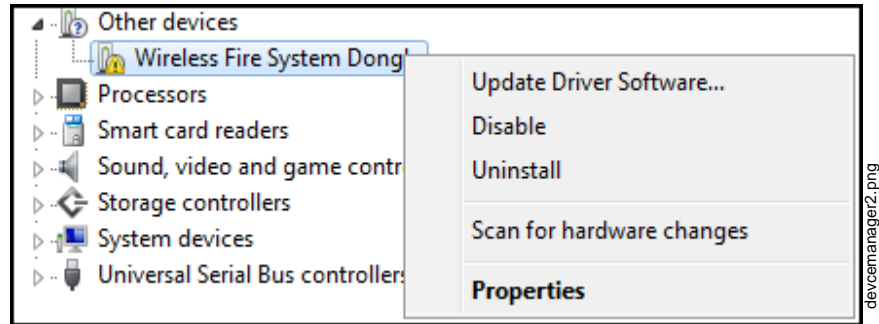

Figure 5.3 Update Driver Software

3. Select the **Browse my computer for driver software** option.

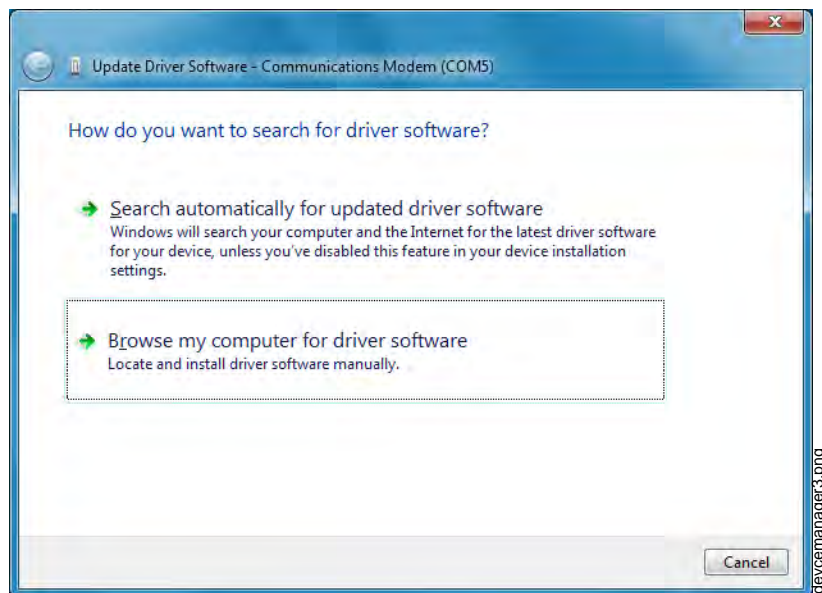

Figure 5.4 Browse Computer for Driver Software

- The Browse dialog box appears. Click **Browse**. Navigate to the folder: c:\Program Files\Honeywell\Device Driver. Click **Next**.

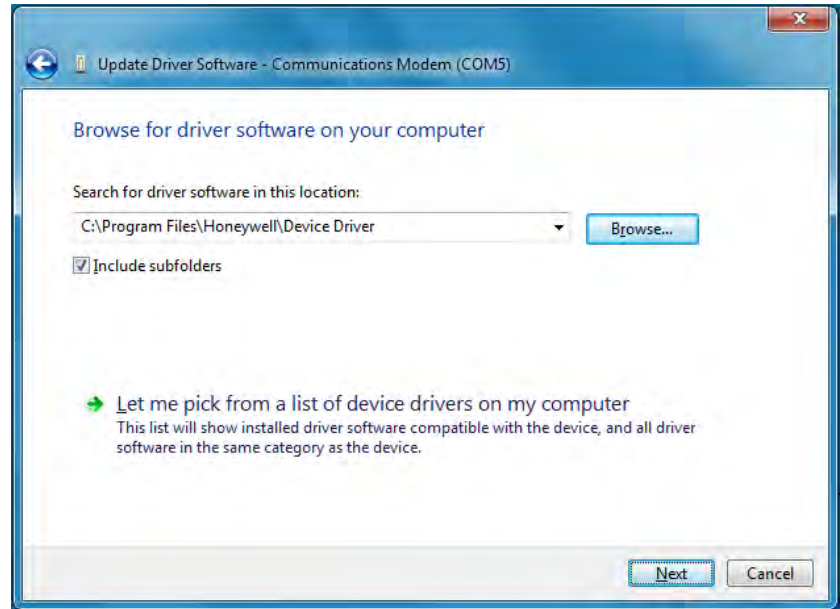

Figure 5.5 Browse Folder for Driver Software

- The confirmation message displays when the driver software is updated successfully.

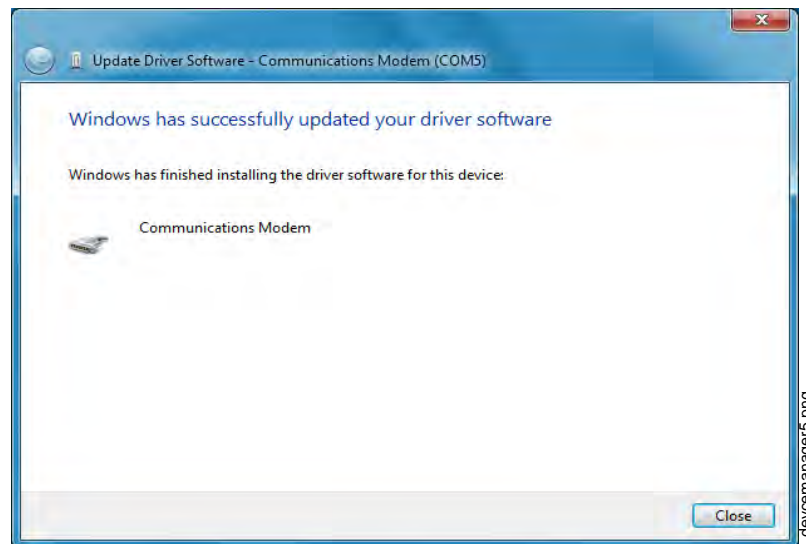

Figure 5.6 Driver Software Update Confirmation

The newly installed device will now display on the computer management screen under Ports.

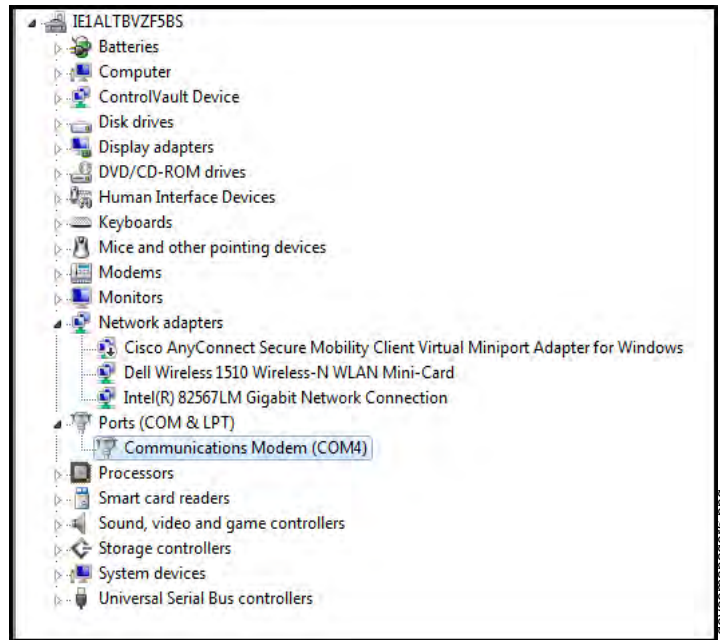

Figure 5.7 New Communications Port

Appendix A: SWIFT Tools

A.1 Description

SWIFT Tools is a standalone desktop Windows® application. It is a configuration and maintenance tool for the W-GATE and devices of the SWIFT Network. Site surveys, device configurations, and diagnostic functions are all part of SWIFT Tools. SWIFT Tools can be installed on a PC or a laptop and communicates with the W-GATE and wireless devices through USB-based user interface. Connect the W-USB adapter to the computer to invoke the SWIFT Tools application. At any point, only one instance of SWIFT Tools can run on a laptop or PC.

SWIFT Tools has the following utilities:

- ✓ Site Survey view
- ✓ Creating Mesh Network
- ✓ Diagnostic view

SWIFT Tools works in a wireless environment with the W-GATE and devices within a range of approximately 20 feet.

SWIFT Tools is designed for systems running Microsoft Windows. Minimum system requirements are listed below.

Component	Minimum Requirement
Operating System	Windows XP Professional (SP3), Vista, Windows 7, and Windows 8 (32 bit and 64 bit)
Hard Drive	20 GB hard drive space with minimum 1GB free space on hard disk.
RAM	Minimum 512MB RAM
Processor speed	1GHz minimum (2.4 GHz recommended) Processor, 512K Cache

Table A.1 System Requirements

A.2 Launching SWIFT Tools

To launch SWIFT Tools,



1. Click **Start**, point to **All Programs**, click **SWIFT Tool**, and then **SWIFT Tool**. The following screen is displayed. Alternatively, SWIFT Tools can be opened through a shortcut located on the desktop.



Figure A.1 SWIFT Tools Start Screen

2. Click **Start Using**. The **SWIFT Tools** screen is displayed. You can create a new jobsite or open an existing one.

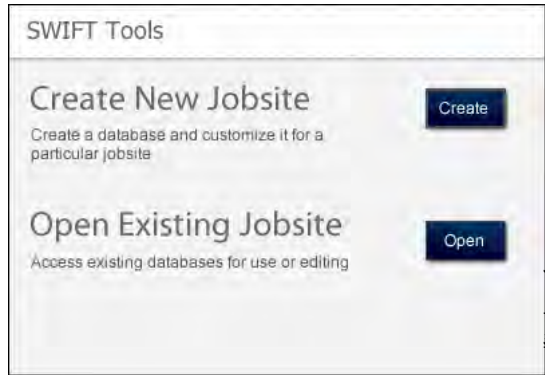

Figure A.2 SWIFT Tools Screen

A.2.1 Creating a New Jobsite

To create a new jobsite:

1. Click **Create** from the PC Tools screen.
2. Enter the name of the new jobsite in the **Jobsite Name** field.
3. Enter the **Location/Description** if any, and click **Create**.
4. The **Create Project** dialog box opens. Navigate to the desired folder location where the project will be saved.
5. Click **Save**.

The jobsite is created and the following screen is displayed. From this screen a site survey may be conducted, a mesh network may be created, and troubleshooting may be performed. Click the **Start** button for the desired function.

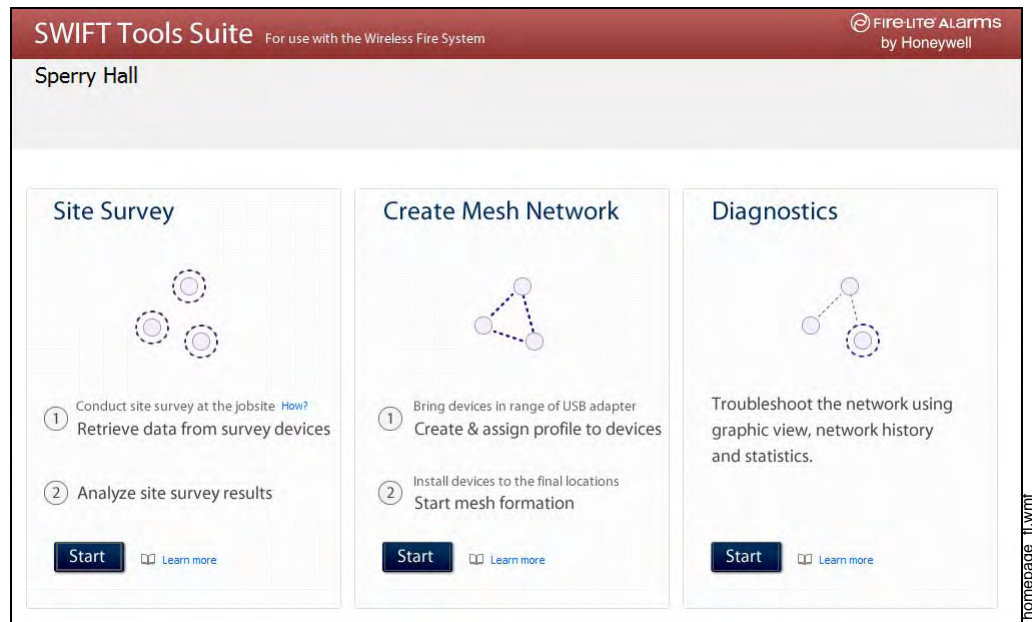

Figure A.3 Home Screen

For more information on performing a site survey, refer to Appendix B. To create a mesh network, see page 21. For help with diagnostics, refer to Appendix C.

A.2.2 Opening an Existing Jobsite

To open an existing jobsite:

1. Click **Open** from the PC Tools screen.
2. Navigate to the folder containing the jobsite file. Select to highlight the file and click **Open**.

The existing jobsite is opened and the following screen is displayed. From this screen a site survey may be conducted, a mesh network may be created, and troubleshooting may be performed. Click the **Start** button for the desired function.

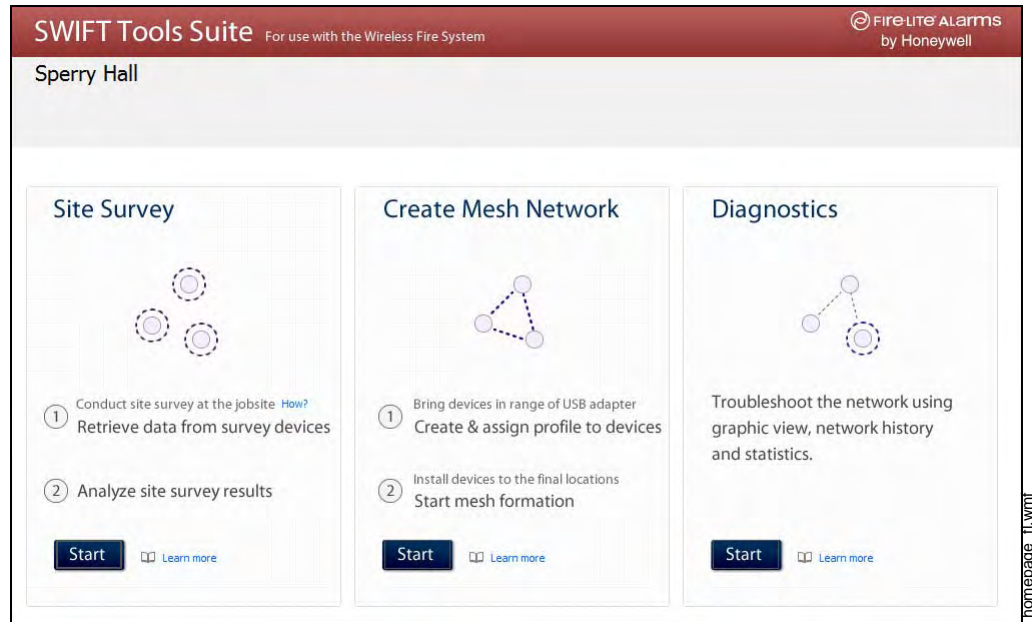

Figure A.4 Home Screen

For more information on performing a site survey, refer to Appendix B. To create a mesh network, see page 21. For help with diagnostics, refer to Appendix C.

Appendix B: Site Survey

A site survey is recommended to assess and qualify the site prior to installing a SWIFT network. The site survey consists of a link quality test and RF scan test. After both tests are completed, the results of the site survey can be obtained using SWIFT Tools. The information provided by SWIFT Tools is used for site qualification, maximum device spacing identification, and configuring the network. This helps to improve the reliability and performance of the wireless network in the wireless fire alarm system.

B.1 Conduct a Site Survey

B.1.1 Link Quality Test

A link quality test is a quick and repeatable test that provides immediate feedback on device connectivity. The link quality test sends data from one device to another to test for data loss and measure the signal strength. In a link test, the device addresses are set in the range of 001 to 150. A minimum of two devices are needed to conduct a link quality test.

A link test is conducted between two or more devices. The link test starts when a device that is in the "pending site survey" state has its tamper condition cleared. The device will send a burst of data to the next address lower than its own address. The lower addressed device will automatically return the link quality test results for display using the device LEDs. For example, clearing the tamper condition on a detector set to address 2 (D002) will make the detector enter the link quality test. D002 will send a burst of data to a device at address 001 (either detector or module). The device at address 001 will measure the signal strength and count the data received in the burst and return the information to D002. The results of the test will be displayed at D002. The test can be repeated by tampering D002 to return it to the "pending site survey" mode and then clearing the tamper.

Basic Requirements of a Link Quality Test

To conduct a link test:

- ✓ two or more devices (detectors) are required.
- ✓ devices must be in factory default state. The LEDs on the device will blink single or double red to confirm it is in the factory default state. Refer to Section 4.5.4 on page 50 for more information on setting the device to factory default state.
- ✓ device addresses can be set in the range of 1 to 150.

Conduct a Link Quality Test

To conduct a link quality test:

1. Remove the batteries from the devices that will be used for the site survey and set the SLC address. To set an SLC address, use a common screwdriver to adjust the rotary switches on the device.
 - a. For the first device used in a site survey, set the SLC address to 001.
 - b. For each subsequent device, use the next highest SLC address (up to address 150). For example, the first device was set to 001, set the second device to 002, and the third device to 003, etc.
2. Bring the first device (001) to the first location to conduct the test.
3. Insert *one* battery into the device. Inserting more than one battery deters the device from entering the site survey mode. The device is ready for site survey mode if the LED blinks red twice every 5 seconds.
4. Clear the tamper condition to proceed with the test. To clear the tamper condition on a detector, insert the detector into the base and twist to lock the detector completely into the base. To clear the tamper condition on a module, attach the faceplate to the module. When the tamper is

cleared, the LEDs on the device starts blinking yellow every ½ second for approximately 20 seconds. The results appear in approximately 20 seconds and the LEDs on the first device change to solid red. This is due to the absence of a lower-addressed device with which to form a pair. This result is expected from the 1st device when when a link quality test is performed.

5. Bring the second device (002) to the second location and repeat steps 3 and 4.
6. The device will conduct a link test to the next lowest address; in this case device 001. The result of the link test from 002 to 001 is displayed by the LEDs on device 002. Refer to Table B.1 below.
7. Once the link test is complete between 002 and 001, continue for address 003, 004, etc. for all devices that will be used in the site survey. This test may be repeated any number of times. For devices addressed to 101 or higher, the test must be repeated, if desired, within five minutes of the last concluded test or the devices will start an RF scan test.

Results of a Link Quality Test

The following table explains the LED patterns before and during a link quality test.

State	Pattern	LED	Results & Description
Site survey pending	Double blink every 5 seconds	Red	Device is tampered, ready and waiting to start a site survey link quality test
Link quality test in progress	Single blink every ½ seconds	Yellow	Transmission of data to another device.
Link quality test complete	On steady	Red	Failure - no data received
Link quality test complete	Single blink every 5 seconds	Red	Poor - partial data received or signal strength measured lower than the acceptable limit for a primary or secondary link (-81dBm or lower)
Link quality test complete	2 blinks every 5 seconds	Green	Marginal - all data received at a signal strength acceptable for a secondary link but not for a primary link (-61dBm to -80dBm)
Link quality test complete	3 blinks every 5 seconds	Green	Good - all data received at a signal strength acceptable for a secondary link and marginally acceptable for a primary link (-51dBm to -60dBm)
Link quality test complete	4 blinks every 5 seconds	Green	Excellent - all data received at a signal strength acceptable for a primary link (-50dBm or better)

Table B.1 LED Patterns of Link Quality Test Results

The LED pattern for a link quality test will continue to be displayed until the device is tampered or the batteries die for a device that is addressed 100 or lower. For devices addressed 101 to 150, the result will be displayed until the device starts the RF Scan.

To repeat the link quality test, toggle the tamper state. To toggle the tamper state on a detector, twist the detector in the base counter-clockwise as if removing the detector from the base, then twist it back in clockwise to lock it in. To toggle the tamper state on a module, remove the face-plate and then reconnect it. Once the device is tampered, it will return to the pending site survey state. Once the tamper is cleared, the link quality test will be restarted. Only the results for the last link quality test are retained.

After a Link Quality Test

Retrieve the link quality test results for devices 001-100. To retrieve the site survey results, refer to the topic B.1.3, "Retrieving Site Survey Results" at the end of this section. For devices 101-150, wait to retrieve the link quality results until the device starts an RF Scan test.

B.1.2 RF Scan Test

A Radio Frequency scan test is conducted to assess and measure the background noise and interference from other wireless systems if any, in the site. The RF Scan test can be conducted individually or following the link quality test. An RF Scan test will be conducted for any device with an SLC address set between 101 and 150 at the end of a Link Quality Test.

Conduct an RF Scan Test

To conduct an RF scan test, follow the same procedure for a link quality test. However, the device addresses for an RF scan test must start at 101 and have the subsequent devices address set as 102, 103, etc. Each device will conduct the link quality test as described above, then transition to the RF scan test 5 minutes after the last link quality test is performed to or from that device.

If several devices are being tested, it is possible that some devices will start and complete the link test and progress to the RF scan test while other devices are finishing the link quality test. The RF Scan test may take up to 70 minutes. The time remaining and the test status are displayed at the device using the LEDs. The LED patterns are shown below.

Status of an RF Scan Test

State	Pattern	LED	Status
In Progress- 70 minutes remaining	7 short blinks every 30 seconds	Red	Bad
		Green	Good
In Progress- 60 minutes remaining	6 short blinks every 30 seconds	Red	Bad
		Green	Good
In Progress- 50 minutes remaining	5 short blinks every 30 seconds	Red	Bad
		Green	Good
↓	↓		
In Progress- 10 minutes remaining	1 short blink every 30 seconds	Red	Bad
		Green	Good
RF Scan Test Complete	On Steady	Red	Bad
		Green	Good

Table B.2 RF Scan Test Status - LED Pattern

B.1.3 Retrieving Site Survey Results

To retrieve the site survey results:

1. Return the device to "Pending Site Survey" or "Factory Default" mode. This is done by tampering devices that have completed a link quality test or by rebooting devices that have completed an RF scan test.



CAUTION: SITE SURVEY RESULTS WILL BE REPLACED

DO NOT CLEAR THE TAMPER ON A DEVICE THAT IS IN THE "PENDING SITE SURVEY" STATE OR THE EXISTING RESULTS WILL BE REPLACED.

2. Plug the USB adapter into the laptop/PC where SWIFT Tools has been installed.
3. Bring the devices within a range of approximately 20 feet from the USB adapter connected to the laptop/PC.
4. Logon to SWIFT Tools and retrieve the data.

Appendix C: Troubleshooting and Testing

C.1 Troubleshooting

Problem	Description	Action
Class A fault condition	Device has a single parent connection, and is missing the redundant class A connection.	If a suitable parent is available, the background mesh restructuring routine should self-heal the network. If the network does not self-heal after ten minutes, reduce spacing between devices or utilize SWIFT Tools for suggested repeater placement to add stronger parents. Toggle mesh formation to trigger a mesh restructuring routine to re-evaluate the trouble condition after taking action.
Jamming	Jamming occurs when a device is overloaded with an interfering RF signal and is unable to process incoming messages, but is able to report the condition to its parents.	A jammed device will automatically remove itself from the mesh network after reporting the jamming. The device will attempt to self-heal and recover into the network. Identify any possible sources of the jamming signal and see if the spacing from the device to the jamming source can be increased to an acceptable range. A site survey RF scan test can be used to categorize the jamming signal.
Low battery	One or more of the four batteries are missing/dead and/or the device has a minimum of one week of operation remaining.	To clear the low battery event, tamper the device and replace all four batteries. When a device is tampered, it drops out of the mesh network and attempts to rejoin as soon as the batteries are replaced and the tamper event is cleared. Once a low battery trouble is indicated there is a minimum of one week of operation before the device is non-functional.
Duplicate address/ Illegal address	Two or more wireless devices on the same mesh network that are set to the same address report a duplicate address trouble. An address set to zero will report an illegal address.	Change the address of the device(s) to avoid duplication and error.
Mesh formation does not find all devices	A device does not connect to the gateway/mesh network	Verify the device has a profile. Verify that the profile matches the profile in the gateway. Two different profiles may use the same mesh ID. Remove and re-profile the device to guarantee the correct profile. Verify the device is powered and the tamper condition is cleared. Check the device spacing and the range from the device to the mesh. A site survey link test can be used to verify connectivity from one location to another.
Mesh restructuring does not end	The gateway/mesh network appears to be stuck in mesh restructuring	Use SWIFT Tools or panel history to investigate for the presence of walkie talkie interference or unstable devices (dropping and joining). Walkie talkie interference will prohibit restructuring from fully executing. Devices joining a mesh will delay the restructuring event.
Devices drop during operation	A device drop event is indicated in history.	Device drop is the predecessor to a No Answer/Invalid reply trouble. Inspect the area for any changes to the environment that could block radio communication. Use a site survey RF Scan to check for any interference and use a site survey link test to check the connectivity from the device to its closest neighbor.

Problem	Description	Action
Max gateway trouble reported	The number of Honeywell SWIFT systems that can co-exist in range of each other has been exceeded.	Use the network statistics provided by SWIFT Tools to identify the interfering networks and the nature of the fault. The networks will be listed by a unique number; this is not the serial number of the gateway. One or more of the systems will need to be powered down to clear the fault. Where possible, maximize the number of devices on a mesh network to reduce the number of total mesh networks; i.e. use one mesh network with 50 devices instead of two mesh networks with 25 each. Restructure the layout of the mesh networks to group devices and the gateway to avoid overlap. It may take 36 hours for the fault to clear. This can be expedited by toggling the state of mesh formation.
Device does not rejoin the mesh after battery replacement	Device is an invalid reply/no answer after replacing the batteries.	Verify the tamper condition is cleared. Use mesh formation to have the device rejoin the mesh network. Low battery and tamper are both latching conditions. Ensure a reset has been initiated to clear those events.
Low battery trouble reported after battery replacement	Low battery trouble is still indicated after replacement.	Use the network statistics provided in SWIFT Tools to see the battery voltage measured for each individual battery. Verify that each battery is present and at a suitable voltage level. The low battery trouble is a latching trouble, ensure a reset has been initiated since the replacement.
Site survey does not find a link	Solid red results for the link test	Verify the addresses of the devices used during the test. The lower addressed device must complete its link test before the device at the next higher address starts the link test. Verify the devices are in range of each other.
SWIFT Tools does not import site survey data	Selecting the device in the communicator in SWIFT Tools does not have an effect	The device does not have any site survey results to be imported. It has not found a link during the link test and/or it has not collected any data for an RF Scan.
SWIFT Tools says device/gateway is out of range	Device or gateway is not communicating to SWIFT Tools	Verify the device or gateway is powered on and in a state that supports SWIFT Tools communication. For instance, a device in the mesh network does not communicate to SWIFT Tools. It communicates to the gateway. A device that has completed a site survey does not communicate to SWIFT Tools until it returns to the pending site survey state or factory default state. Move the Adaptor in range of gateway/devices.
Scan does not find any devices	All devices are out of range	Verify at least one device is in range of SWIFT Tools, the USB adapter is connected, and the scan is on. SWIFT Tools processes the messages faster with multiple devices in range. If only one device is in range it can take up to 1 minute for the scan to detect the device.
Site survey devices are not displayed in the communicator of SWIFT Tools.		Verify the device is in the pending site survey mode or factory default mode. The device will not communicate with SWIFT Tools while it is in site survey mode.
FACP reports invalid reply/No Answer for the gateway	Gateway is not communicating with the panel	Verify the loop is running in FlashScan for detectors and modules. Verify the gateway is set to a valid address.
FACP reports invalid reply/No answer for the wireless detectors	FACP does not recognize the detectors	Verify the loop is running in FlashScan for the detectors. Verify using SWIFT Tools that the detectors are part of the mesh network.
FACP reports invalid reply/No answer for the wireless modules	FACP does not recognize the modules	Verify the loop is running in FlashScan for the modules. Verify using SWIFT Tools that the modules are part of the mesh network.

Problem	Description	Action
Device does not receive a profile	A profile request has been initiated but timed out before receiving a profile	Ensure the gateway or distributor is still in distributor mode. Ensure the device is in range of the gateway or distributor. If there are multiple devices in range, the might be interfering with the profile transfer. Move the distributor and device to a different area or shut down the peripheral devices.
Application download fails	SWIFT Tools failed to finish a download	Verify the number of devices in range of the USB adapter during the download does not exceed the recommended limit of 10 devices. Verify the device is in range and powered on during the download process.
Device is in bootloader	Device/Gateway is indicating the LED pattern for bootloader and it is indicated as being in bootloader in the communicator of SWIFT Tools.	The device failed to load or initialize the application. Reboot the device. If it is still in bootloader, the application will need to be updated using SWIFT Tools. If problem persists, contact technical support.
Key Bus trouble	The ANN-80 has lost connection with the W-DIS-D.	Check the connection between the ANN-80 and the W-DIS-D and reboot the W-DIS-D.

C.2 Testing the W-GATE and Devices

The W-GATE must be tested after installation and be part of a periodic maintenance program. The testing methods must satisfy the Authority Having Jurisdiction (AHJ). The W-GATE provides optimum performance when tested and maintained in compliance with NFPA 72 ordinances.

C.2.1 Testing LED Indicators

For more information on LED indicators, refer to Appendix D, “LED Indicators”, on page 69.

C.3 Testing the Wireless Network

Using the SWIFT Tools application, users can:

- Diagnose and troubleshoot the wireless network and connectivity of the devices.
- Monitor the wireless network topology, quality of the communication links between the devices, live and historical event reports for troubleshooting purposes.
- View the parent-child relationship and the signal strength between the two devices, and identify the device that has lost the communication link with the wireless network.

In addition, SWIFT Tools:

- Communicates with the W-GATE to retrieve live information about the connectivity and status of the devices.
- Stores the wireless network data such as network map, parent-child information, device information, history events, and network statistics.

The SWIFT Tools application allows retrieval of the following information for diagnosing and troubleshooting purposes.

- Network Topology
- History of Events
- Network Snapshots
- Network Statistics
- Device Attributes

C.3.1 Network Topology

Parent-Child Devices

The parent-child relationship between the devices in the wireless network is displayed using the directional arrows.

Orphan Devices

A device that is not linked with any other device in the wireless topology is an orphan device. The device is represented as an orphan device due to one of the following reasons:

- The device was originally a part of the wireless network and was dropped.
- When the network topology was retrieved, the device detail was not retrieved.
- The network connections are saturated and parent-child connection with the device is not established.

Class A Compliance

Each device must comply with Class A guidelines. Every device must have two parent devices to be compliant with the Class A guidelines.



NOTE: The device image in SWIFT Tools is altered to depict that it does not meet the required guidelines.



NOTE: Class A guidelines are not applicable to the W-GATE.

Selecting a device from the graphical representation and clicking either left or right allows you to view the following details. The Network Topology window allows you to click either left or right on any connected or orphan device.

C.3.2 History Events

History events of the wireless network can be retrieved and viewed using SWIFT Tools for troubleshooting purposes. This report provides information on when the device gets connected with the wireless network, mode change, and slot change details.

C.3.3 Network Snapshots

Network snapshots can be retrieved and viewed using SWIFT Tools for troubleshooting purposes. The network snapshot helps to analyze how the wireless network is functioning over a period of time.

C.3.4 Network Statistics

Network statistics of the wireless network can be retrieved and viewed using SWIFT Tools for troubleshooting purposes. The network statistics provide information on the attributes and RSSI of a device. The attributes provide information on the retransmission count and device re-join events. The retransmission count is the number of times a device retransmits the wireless signal. The device re-join events is the number of times the devices get disconnected from the wireless network and get connected with the wireless network. The RSSI of a device displays the parent-child relationship between the devices.









C.3.5 Device Attributes

Device attributes can be retrieved and viewed using SWIFT Tools for troubleshooting purposes. The attributes of a device such as low indication, removal indication, level, tamper fault, and others are retrieved.

Appendix D: LED Indicators

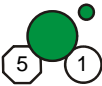
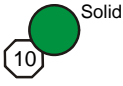
The LED indicator patterns for the wireless gateway, display driver, and wireless devices are shown in the tables below.

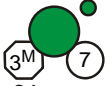
Gateway LED Patterns

LED Pattern	Condition	Action Required
 Bootloader normal	Device is ready to update.	
 Bootloader Firmware update	New application code is being downloaded.	
 Mesh formation	Gateway is forming the mesh and looking for devices that are not in the mesh.	Wait until all devices join the mesh and then terminate mesh formation.
 Mesh formation with profile distribution	Gateway is forming the mesh and looking for devices that are not in the mesh. The gateway is also distributing a profile to any device that requests a profile.	Wait until all devices join the mesh and then terminate mesh formation or wait until the gateway automatically terminates mesh formation.
 Profile removed	Gateway has returned to the factory default state.	
 Profile accepted	Gateway is now profile assigned.	
 Normal mode/ background mesh restructuring	Normal operation of the gateway	
 Normal mode/ background mesh restructuring with profile distribution	Normal operation of the gateway. The gateway is also distributing a profile to any device that requests a profile.	
 Rescue mode	Gateway and the mesh network are searching for any device that is not in the mesh network with the same profile.	
 Rescue mode with profile distribution	Gateway and the mesh network are searching for any device that is not in the mesh network with the same profile. The gateway is also distributing a profile to any device that requests a profile.	

Legend

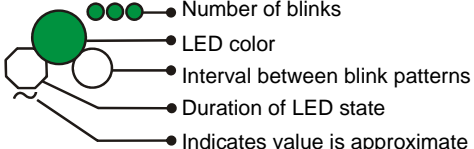





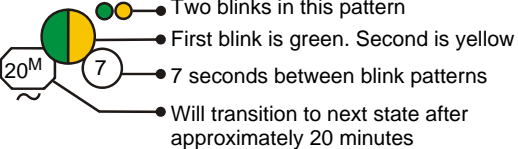

All units are in seconds. Minute is indicated by "M".

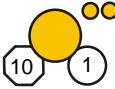

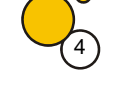
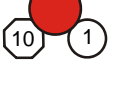
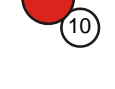

Example:



Gateway LED Patterns (Continued)

LED Pattern	Condition	Action Required	
	Profile assigned; pending magnetic sensor activations	Gateway is starting up with a profile.	Activate both magnetic sensors simultaneously within 10 seconds to remove a profile.
	1st mesh restructuring	Mesh is formed and initializing.	Ensure all devices in the mesh have a valid address.
	1st mesh restructuring with profile distribution	Mesh is formed and initializing. The gateway is also distributing a profile to any device that requests a profile.	
	Trouble	The gateway has a trouble condition.	Refer to the FACP to identify the trouble and possible solution.
	Trouble with profile distribution	The gateway has a trouble condition. The gateway is also distributing a profile to any device that requests a profile.	Refer to the FACP to identify the trouble and possible solution.
	Address zero trouble	The gateway address is set to zero.	Ensure all devices in the mesh have a valid address.
	Factory default; pending magnetic sensor activation	Gateway is starting up without a profile.	Activate either magnetic sensor within 10 seconds to create a profile.
	Waiting for a profile	Gateway is in factory default mode.	Use SWIFT Tools to assign a profile or activate magnetic sensor to search for a profile.
	Searching for a profile	Gateway is in factory default mode and requesting a profile from a distributor or another gateway.	
	Create profile	Gateway is creating a profile.	





Legend

-  Number of blinks
-  LED color
-  Interval between blink patterns
-  Duration of LED state
-  Indicates value is approximate

All units are in seconds. Minute is indicated by "M".

Example:



-  Two blinks in this pattern
-  First blink is green. Second is yellow
-  7 seconds between blink patterns
-  Will transition to next state after approximately 20 minutes

ledgate2.wmf

Display Driver LED Patterns

LED Pattern	Condition	Action Required
	Bootloader normal	Display driver is ready to update. Use SWIFT Tools to initiate download.
	Slot request rejected	Display driver is not permitted into the mesh. Confirm device count and software version.
	Mesh formation	Display driver is in the mesh and looking for devices that are not in the mesh.
	Bootloader firmware update	New application code is being downloaded.
	Profile removed	Display driver has returned to the factory default state.
	Profile received	Display driver is now profile assigned.
	Rescue mode	Display driver is functioning as normal and searching for lost devices.
	Normal mode	Display driver is functioning as normal.
	Self test fail	Display driver has failed internal self diagnostics. Restart the device. If the problem persists, contact technical support.
	Profile assigned, pending magnetic sensor activations	Display driver is starting up with a profile. Activate both magnetic sensors simultaneously within 10 seconds to remove a profile.

Legend

- Number of blinks
- LED color
- Interval between blink patterns
- Duration of LED state
- Indicates value is approximate

All units are in seconds. Minute is indicated by "M".

Example:

- Two blinks in this pattern
- First blink is green. Second is yellow
- 7 seconds between blink patterns
- Will transition to next state after approximately 20 minutes

Display Driver LED Patterns (Continued)

LED Pattern	Condition	Action Required
	<p>Searching for mesh (in rescue mode)</p> <p>Profile is assigned and display driver is searching for the mesh.</p>	<p>Ensure the mesh is in rescue mode or wait for timeout to search mesh in formation mode.</p>
	<p>Searching for mesh (in formation mode)</p> <p>Profile is assigned and display driver is searching for the mesh.</p>	<p>Ensure the mesh is in formation mode.</p>
	<p>1st mesh restructuring</p> <p>Mesh is formed and initializing.</p>	
	<p>Generic trouble condition</p> <p>Display driver is in the mesh and in a trouble condition.</p>	<p>Refer to the FACP to identify the trouble and possible resolution.</p>
	<p>Waiting for profile</p> <p>Display driver is in the factory default state.</p>	<p>Use SWIFT Tools to assign a profile or activate magnetic sensor to search for a profile.</p>
	<p>Searching for profile</p> <p>Display driver is in factory default mode and requesting a profile from a distributor or gateway.</p>	

Legend

- Number of blinks
- LED color
- Interval between blink patterns
- Duration of LED state
- Indicates value is approximate













All units are in seconds. Minute is indicated by "M".

Example:

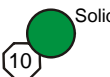
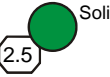
- Two blinks in this pattern
- First blink is green. Second is yellow
- 7 seconds between blink patterns
- Will transition to next state after approximately 20 minutes

ledcd2.wmf

Device LED Patterns

LED Pattern	Condition	Action Required
	Device is ready to update.	Use SWIFT Tools to initiate download.
	Device is not permitted into the mesh.	Confirm device count and software version.
	Device is part of the mesh and looking for devices that are not in the mesh.	
	Device is tampered.	Ensure detector is seated in the base and the module has the faceplate on.
	New application code is being downloaded.	
	Device has returned to the factory default mode.	
	Device is now profile assigned.	
	Maximum life of installed batteries remaining in device	
	Device is distributing its profile to other devices which requested a profile.	
	Device is functioning as normal and searching for lost devices.	
	Device is distributing as normal	
	Device has failed internal self diagnostics.	Restart the device. If problem persists, contact technical support.
	Device is functioning.	Replace batteries.

Legend

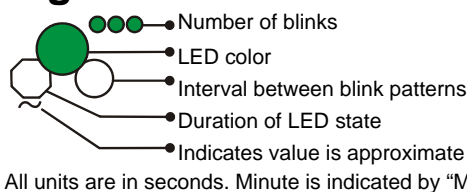



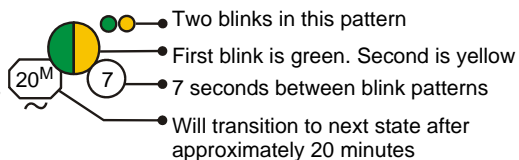





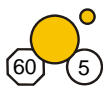

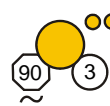

Example:

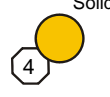

leddev1.wmf

Device LED Patterns (Continued)

LED Pattern	Condition	Action Required
 <p>Profile modification</p>	Device has a profile and can be set as a distributor or have profile removed.	Toggle SLC address dials to respective pattern to enter desired mode.
 <p>Battery Check: all batteries present</p>	Minimum of 6 months battery life remaining.	
 <p>Searching for mesh (in rescue mode)</p>	Profile is assigned and device is searching for the mesh.	Ensure the mesh is in rescue mode or wait for timeout to search mesh in formation mode.
 <p>Searching for mesh (in formation mode)</p>	Profile is assigned and device is searching for the mesh.	Ensure the mesh is in formation mode.
 <p>1st mesh restructuring</p>	Mesh is formed and initializing.	
 <p>Generic device trouble (dual address, low battery, etc.)</p>	Device is in the mesh and in a trouble condition.	Refer to the FACP to identify the trouble and possible resolution.
 <p>Tamper entry</p>	Device has just been tampered.	Ensure detector is seated in the base and the module has a faceplate.
 <p>Discovered mesh</p>	Device discovered the mesh.	
 <p>Battery Check: weak</p>	Less than 6 months battery life left or not all 4 batteries are present.	Ensure all 4 batteries are present or replace the batteries.
 <p>Alarm state</p>	Device is functioning as normal and has been activated.	
 <p>Waiting for a profile</p>	Device is in factory default mode.	Use SWIFT Tools to assign a profile or activate magnetic sensor to search for a profile.
 <p>Searching for a profile</p>	Device is in factory default mode and requesting a profile from a distributor or gateway.	
 <p>Pending site survey</p>	Device is in factory default mode and is ready to enter site survey mode.	Clear the tamper condition within 1 minute to enter site survey mode.

Legend

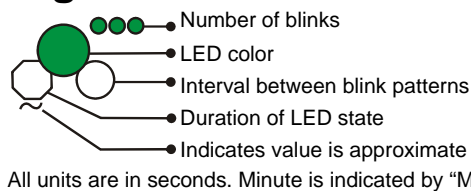

Example:

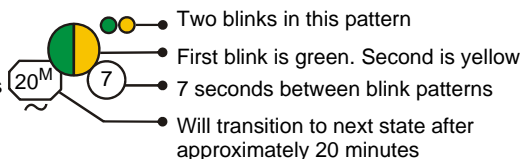

leddev2.wmf

Index

A

- abbreviations **10**
- additional references **9**
- address **22**
- ANN-80 **39, 41**
 - audible indicators **42**
 - buttons **41**
 - capacity exceeded **44**
 - clearing messages **44**
 - degraded connection **43**
 - duplicate address **43**
 - event messaging **42**
 - key bus trouble **43**
 - low battery **42**
 - maximum gateways **44**
 - mesh formation **42**
 - system initialization trouble **43**
 - tamper event **43**
 - visual indicators **41**
 - weak link **43**
- assign profile **36, 46, 51**
- assumed knowledge **9**
- attributes **68**
- audible indicators **42**

B

- bootloader **25, 40, 52**
- buttons **41**
 - ANN-80 **41**

C

- capacity exceeded **44**
- Class A compliance **67**
- Class A trouble **43**
- clearing messages **44**
- collapse network command **27**
- configuration **17, 36**
 - ANN-80 **39**
- configure profile **23, 40**
- CR123A batteries **45**
- create profile **17**
- creating jobsite **59**

D

- default **38, 40**
- degraded connection **43**
- detector
 - assign profile **46**
 - transfer profile **46**
- device
 - attributes **68**

- bootloader **52**
- distributor **52**
- factory default **51**
- initial mesh restructuring mode **52**
- LED indicators **52**
- mesh formation **52**
- mesh participant **52**
- network snapshots **67**
- network statistics **67**
- normal mode **52**
- profile assigned **51**
- rescue mode **52**
- site survey **51**
- device operations **51**
- device spacing **61**
- devices **45**
 - Class A compliance **67**
 - configuration and programming **46**
 - installing **46**
 - orphan **67**
 - parent-child **67**
- disable trouble reporting **26**
- display **39**
- display driver
 - specifications **32**
- distributor mode **49**
- distributor **52**
- dongle **53**
- duplicate address **43**

E

- event **39**
- event messaging **42**
- existing profile **18**

F

- factory default **23, 38, 40, 50, 51**

G

- gateway **11**
 - bootloader **25**
 - collapse network **27**
 - configuration **17**
 - create mesh network **18**
 - description **11**
 - disable trouble reporting **26**
 - existing profile **18**
 - factory default **23**
 - initial mesh restructuring **24**
 - LED indicators **13**
 - lock/unlock **25**

- mesh formation **21, 23**
- mesh restructuring **24**
- mounting **13**
- new profile **17**
- normal mode **24**
- password reset **26**
- power **16**
- profile configure **23**
- profile distribution **21**
- programming **17**
- remove profile **18**
- rescue mode **24**
- restrictions **29**
- RF interference **30**
- silence network **28**
- SLC configuration **22**
- SLC connections **15**
- specifications **12**
- start-up **23**
- weak link trouble **26**
- wiring **15**

H

- heat detector **45**

I

- initial mesh restructuring **24**
- initial mesh restructuring mode **52**
- installing devices **46**
- interference **30**
- isolator modules **16**

J

- jobsite
 - new **59**
 - open **60**
- jumper **14**

K

- key bus trouble **43**

L

- latching **22**
- LED indicators **13, 18, 19, 33, 36, 52**
- link quality test **61**
 - procedure **61**
 - requirements **61**
- lock **25**
- low battery **42**

M

- magnetic sensor **12, 18, 19, 21, 22, 33, 36, 49**
- magnetic sensors **33**

- maximum gateways **44**
- mesh formation **19, 21, 23, 38, 42, 49, 52**
- mesh formation mode **40**
- mesh network **18, 22, 23**
- mesh participant **52**
- mesh restructuring **24**
- mode
 - mesh formation **40**
 - normal **40**
 - rescue **40**
- modes of operation **23, 51**
- module
 - assigning profiles **46**
 - batteries **45**
- module configuration **46**
- module installation **46**
- monitor module **45**
- mounting **13**

N

- network installation restrictions **29**
- network limit **29**
- network snapshots **67**
- network statistics **67**
- network topology **67**
- normal mode **24, 40, 52**

O

- opening jobsite **60**
- operations **23, 39**
 - ANN-80 **41**
- orphan devices **67**
- overlapping networks **29**

P

- parent-child devices **67**
- password reset **26**
- profile
 - assigned **51**
 - assigning **36**
 - configure **23**
 - create new **17**
 - remove **20, 50**
 - removing **18**
- profile configured **40**
- profile distribution **21**
- programming **17**
- pull station **45**

R

- related documents **9**
- remove profile **18, 20, 50**
- repeater **43**
- rescue mode **24, 40, 52**

- restrictions **29**
 - installation **29**
- RF interference **30**
- RF scan test **63**
 - status **63**
- RF spectrum **29**
- rotary switches **50**

trouble reporting **26**

- weak link trouble **43**

- W-GATE **11**
 - specifications **12**
- wireless devices **45**
- wireless display driver **31**
- wireless gateway **11**
- wiring **15**

S

- sensor
 - magnetic **19**
- silence network command **28**
- site survey **51, 61**
- SLC cconfiguration **22**
- SLC connections **15**
- SLC operation **41**
- smoke detector **45**
- specifications **12, 32, 54**
- spectrum **30**
 - RF **29**
 - spread **30**
- spread spectrum **30**
- start-up **23**
- supervisory event **32**
- SWIFT Tools **58, 66**
- system initialization trouble **43**

T

- tamper **22**
- tamper event **43**
- testing **66**
- transfer profile **46**
- transmission **24**
- trouble **43**
- trouble condition **24, 26**
- trouble event **31**
- trouble reporting
 - disable **26**
- troubleshooting **64**

U

- unlock **25**
- USB adapter **53**
 - specifications **54**

V

- visual indicators **41**

W

- walkie talkie mode **30**
- W-DIS-D **31**
 - operations **39**
 - specifications **32**
- weak link

Notes

Manufacturer Warranties and Limitation of Liability

Manufacturer Warranties. Subject to the limitations set forth herein, Manufacturer warrants that the Products manufactured by it in its Northford, Connecticut facility and sold by it to its authorized Distributors shall be free, under normal use and service, from defects in material and workmanship for a period of thirty six months (36) months from the date of manufacture (effective Jan. 1, 2009). The Products manufactured and sold by Manufacturer are date stamped at the time of production. Manufacturer does not warrant Products that are not manufactured by it in its Northford, Connecticut facility but assigns to its Distributor, to the extent possible, any warranty offered by the manufacturer of such product. This warranty shall be void if a Product is altered, serviced or repaired by anyone other than Manufacturer or its authorized Distributors. This warranty shall also be void if there is a failure to maintain the Products and the systems in which they operate in proper working conditions.

MANUFACTURER MAKES NO FURTHER WARRANTIES, AND DISCLAIMS ANY AND ALL OTHER WARRANTIES, EITHER EXPRESSED OR IMPLIED, WITH RESPECT TO THE PRODUCTS, TRADEMARKS, PROGRAMS AND SERVICES RENDERED BY MANUFACTURER INCLUDING WITHOUT LIMITATION, INFRINGEMENT, TITLE, MERCHANTABILITY, OR FITNESS FOR ANY PARTICULAR PURPOSE. MANUFACTURER SHALL NOT BE LIABLE FOR ANY PERSONAL INJURY OR DEATH WHICH MAY ARISE IN THE COURSE OF, OR AS A RESULT OF, PERSONAL, COMMERCIAL OR INDUSTRIAL USES OF ITS PRODUCTS.

This document constitutes the only warranty made by Manufacturer with respect to its products and replaces all previous warranties and is the only warranty made by Manufacturer. No increase or alteration, written or verbal, of the obligation of this warranty is authorized. Manufacturer does not represent that its products will prevent any loss by fire or otherwise.

Warranty Claims. Manufacturer shall replace or repair, at Manufacturer's discretion, each part returned by its authorized Distributor and acknowledged by Manufacturer to be defective, provided that such part shall have been returned to Manufacturer with all charges prepaid and the authorized Distributor has completed Manufacturer's Return Material Authorization form. The replacement part shall come from Manufacturer's stock and may be new or refurbished. THE FOREGOING IS DISTRIBUTOR'S SOLE AND EXCLUSIVE REMEDY IN THE EVENT OF A WARRANTY CLAIM.

Warn-HL-08-2009.fm



World Headquarters
1 Firelite Place
Northford, CT 06472-1653 USA
203-484-7161
fax 203-484-7118

www.firelite.com

ISO 9001
CERTIFIED
ENGINEERING & MANUFACTURING
QUALITY SYSTEMS