

Thank you for using our products.
INSTALLATION INSTRUCTIONS
SERIES STH MSR CLUSTER SPEAKER ASSEMBLY

Use this product according to this instruction manual. Please keep this instruction manual for future reference.

MODELS:

STH-2 MSR	Red	2-STH-15SR UL Listed under UL 1480 for Speaker Appliances and 1-DC-MAX-C UL Listed under UL-1638 for strobe appliances.
STH-3 MSR	Red	3-STH-15SR UL Listed under UL 1480 for Speaker Appliances and 1-DC-MAX-C UL Listed under UL-1638 for strobe appliances.
STH-4 MSR	Red	4-STH-15SR UL Listed under UL 1480 for Speaker Appliances and 1-DC-MAX-C UL Listed under UL-1638 for strobe appliances.
STH-2R	Red	2STH-15SR UL listed under 1480 for Speaker Appliances.
STH-3R	Red	3STH-15SR UL listed under 1480 for Speaker Appliances.
STH-4R	Red	4STH-15SR UL listed under 1480 for Speaker Appliances.

NOTE:

- The STH-2R, STH-3R and STH-4R do not have a DC-MAX-C strobe.
- All references to the STH-2MSR, STH-3MSR and STH-4MSR apply to the STH-2R, STH-3R and STH-4R, except for any reference to the DC-MAX-C.

GENERAL:

The series STH-MSR Cluster Speaker Assembly is designed for ceiling or wall mounting in high ambient noise level environments. The Series STH-MSR Cluster Speakers are a speaker/visual alerting system, equipped with UL Listed STH-15SR supervised horn loudspeakers, and a UL Listed DC-MAX-C Strobe, mounted to a galvanized steel enclosure, 10"W X 10"L X 6"D. Speakers and Strobe are pre-wired to the internal terminal block. Each speaker can be wired for single or multiple speaker circuit operation.

The STH-15SR loudspeaker provides multiple power requirements with high dBA output at each power tap. STH models offer a choice of field selectable taps, 1 to 15 Watts for either 25VRMS or 70VRMS audio systems. The Series STH design incorporates a compression driver, mounted on a double re-entrant horn for maximum output at minimum power across a UL rated frequency range of 400 to 4,000Hz and an anechoic range of 400 to 14,000Hz. The speaker line inputs are compatible with standard supervision of circuit wiring by a Voice Control Panel. A capacitor is wired in series with the multi-tap transformer for this purpose. Each loudspeaker meets or exceeds the UL listed standards for audible signal appliances and is capable of operating within the ambient temperature range of 66° C (150° F) to -35° C (-30° F). This unit complies with UL Standard 1480 (Speakers for Fire Protective Signaling Systems). Additional information is available from the Installation Sheet P82697.

The DC-MAX-C strobe is a 5 inch tall, 6.2 inch diameter, cylindrical strobe light. The DC-MAX-C strobe provides a highly visible, clear lens, 100 candela and 60 double flashes per minute that can be seen in all directions. It operates on all standard voltages from 10.5VDC to 31.0VDC. The strobe appliance contains a blocking diode that allows this device to be supervised using standard reverse polarity. The DC-MAX-C strobe complies with UL Standard 1638 and is capable of operating within the ambient temperature range of 66° C (150° F) to -35° C (-30° F). Additional information is available from the Installation Sheet P83857.

NOTE: All **CAUTIONS** and **WARNINGS** are identified by the symbol . All warnings are printed in bold capital letters.

 WARNING: READ THESE INSTRUCTIONS CAREFULLY. FAILURE TO COMPLY WITH ANY OF THE FOLLOWING INSTRUCTIONS, CAUTIONS AND WARNINGS COULD RESULT IN IMPROPER APPLICATION, INSTALLATION AND/OR OPERATION OF THESE PRODUCTS IN AN EMERGENCY SITUATION, WHICH COULD RESULT IN PROPERTY DAMAGE, SERIOUS INJURY OR DEATH TO YOU AND/OR OTHERS.

SPECIFICATIONS (SPEAKER):

Each speaker has a slotted rotating switch used to change the dB setting for the output. Table 1 shows the settings and the outputs.

<i>Table 1: Wattage Selector Switch Settings and dBA</i>					
Setting	dB	70V	dB	25V	dB
1	96	0.9W	93	Not Used	Not Used
2	96	1.8W	96	Not Used	Not Used
3	99	3.8W	96	0.48W	90
4	102	7.5W	99	0.94W	90
5	Not Used	15.0W	102	1.8W	93
6	Not Used	Not Used	Not Used	7.5W	99
7	Not Used	Not Used	Not Used	15.0W	102

⚠ WARNING: WHEELLOCK STRONGLY RECOMMENDS THAT THE VOLTAGE APPLIED TO THESE PRODUCTS BE WITHIN THEIR RATED INPUT VOLTAGE RANGE. THE APPLICATION OF IMPROPER VOLTAGE MAY RESULT IN DEGRADED OPERATION OR DAMAGE TO THESE PRODUCTS, WHICH COULD RESULT IN PROPERTY DAMAGE AND SERIOUS INJURY OR DEATH TO YOU AND/OR OTHERS.

NOTES:

1. Power Handling Capacity (RMS): 15W
2. Sound Dispersion: 70 Degrees
3. Constant Voltage Line: 25Vrms or 70Vrms
4. Frequency Response: UL rated at 400 - 4,000Hz (@ Full Rated Output), Anechoic 400 – 14,000 Hz.
5. Sound Level (Peak): 120dB @ 15W, 1 Meter
6. Dimensions: 7-7/8W X 8-3/4H X 9-5/16L

⚠ CAUTION: Do not place switch in settings marked "not used". Failure to comply with these restrictions may cause damage to components and will void the warranty.

STROBE:

<i>Table 2A: Rating Per UL</i>					
Model Code	Lens Color	Rated Voltage	Input Current	Flash Rate	Typ. Eff. Candela
DC-MAX-C	Clear	10.5 to 31.0 VDC	See Table 2b	60/Min Typical	100cd

<i>Table 2B: DC-MAX-C Input Current Versus Input Voltage</i>		
Voltage (VDC)	12	24
Current (mA)	1010	470

NOTES:

1. Temperature range for all models is -30°F to +150°F (-35°C to +66°C)
2. Flash energy and flash rate are specified for double flash operation.
3. Effective candela is measured per IES specifications.

INSTALLATION INSTRUCTIONS:

SPEAKER WATTAGE SELECTOR SWITCH SETTING:

1. Remove the cable entrance interface adaptor and gasket. (See Installation Sheet P82697)
2. Adjust the Speaker Wattage Selector Switch for the desired dB and wattage setting (Table 1) for each speaker.
3. Replace the cable entrance interface adaptor and gasket.

APPLICATION NOTES:

1. Loosen the 4 Phillips screws holding the cover plate and MAX-DC-C Strobe to the enclosure box. (Figure 1)
2. Remove the cover plate and MAX-DC-C Strobe.

Figure 1: Phillips Screw Location

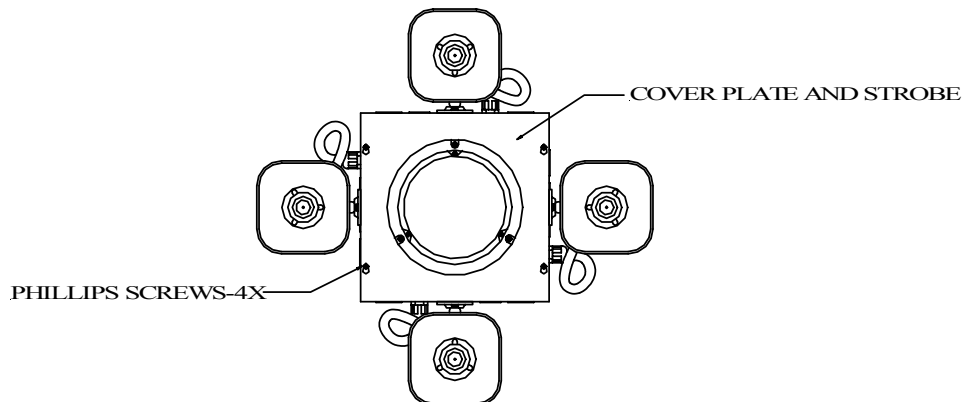

3. Mount the speaker assembly to the desired location.
4. Punch out desired knockouts and attach conduit and fittings.

SPEAKER NUMBERING:

Figure 2: STH-2MSR

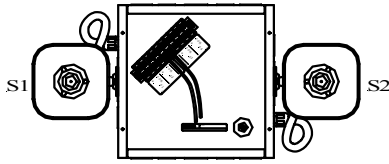

Assembly Weight - 16.7 lbs.

Figure 3: STH-3MSR

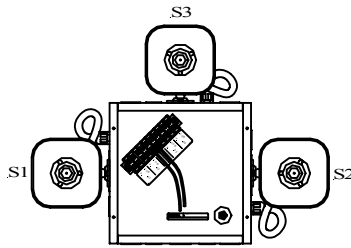

Assembly Weight - 21.2 lbs.

Figure 4: STH-4MSR

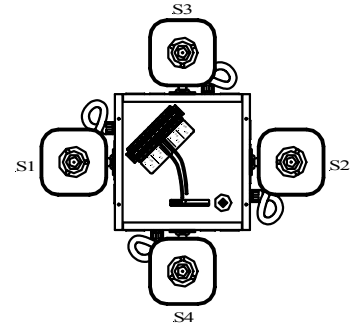

Assembly Weight - 25.7 lbs.

WIRING INFORMATION:

NOTE: The Series MAX Strobe is not designed to operate on a synchronized circuit.

1. Jumper desired speakers together in parallel on the terminal block (Figure 5) using the same gauge wire as input. (Refer to Figure 2, 3 and 4 for proper model numbering sequence.)
2. Attach the speaker input wire to the proper terminals on the terminal block.
3. Attach the 24VDC strobe input wires to the ± 24VDC terminals on the terminal block.

NOTE: Strobe connections do not apply to the STH-2R, STH-3R or STH-4R models.

Figure 5: Terminal Block Layout

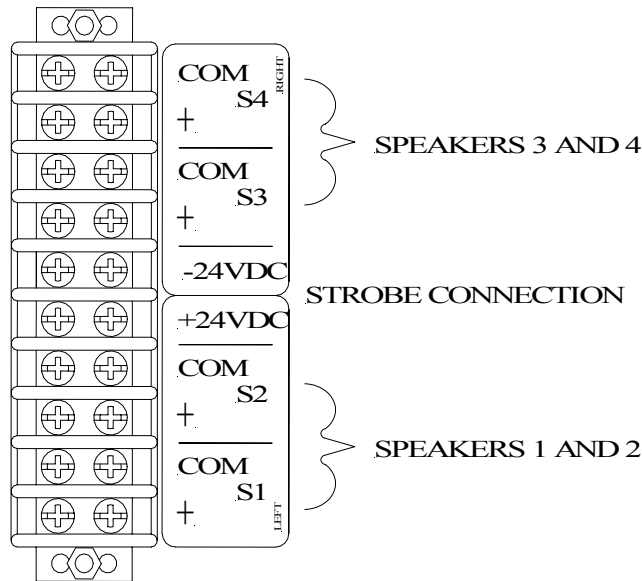

ASSEMBLY:

1. Connect ± 24VDC pre-wires from the terminal block to the strobe pre-wires on the enclosure box cover plate using the wire-nuts (provided). (Red to red. Black to black.)
2. Replace enclosure box cover to the enclosure box and tighten the 4 Phillips Screws.
3. Adjust the angle for the speakers to point in the directions desired.

⚠ CAUTION: Always operate audio amplifiers and speakers within their specified ratings. Excessive input may distort sound quality and may damage audio equipment. Do not exceed +130% of speaker input voltage per UL 1480. Improper input voltage can damage speaker. If distortion is heard, check for clipping of the audio appliance with an oscilloscope and reduce the amplifier input level or gain level to eliminate any clipping.

NOTE: NFPA 72/ANSI 117.1 conform to ADAAG Equivalent Facilitation Guidelines in using fewer, higher intensity strobes within the same protected area.

⚠ CAUTION: Check the installation instructions of the manufacturers of other equipment used in the system for any guidelines or restrictions on wiring and/or locating Notification Appliance Circuits (NAC) and notification appliances. Some system communication circuits and/or audio circuits, for example, may require special precautions to assure electrical noise immunity (e.g. audio cross talk).

ANY MATERIAL EXTRAPOLATED FROM THIS DOCUMENT OR FROM WHEELOCK MANUALS OR OTHER DOCUMENTS DESCRIBING THE PRODUCT FOR USE IN PROMOTIONAL OR ADVERTISING CLAIMS, OR FOR ANY OTHER USE, INCLUDING DESCRIPTION OF THE PRODUCT'S APPLICATION, OPERATION, INSTALLATION AND TESTING IS USED AT THE SOLE RISK OF THE USER AND WHEELOCK WILL NOT HAVE ANY LIABILITY FOR SUCH USE.

IMPORTANT: READ SEPARATE "GENERAL INFORMATION" SHEET FOR INFORMATION ON THE PLACEMENT, LIMITATIONS, INSTALLATION, FINAL CHECKOUT, AND PERIODIC TESTING OF NOTIFICATION APPLIANCES.

Limited Warranty

Wheelock products shall be used within their published specifications and shall be PROPERLY specified, applied, installed, operated, maintained and operationally tested in accordance with these instructions at the time of installation and at least twice a year or more often and in accordance with local, state and federal codes, regulations and laws. Specification, application, installation, operation, maintenance and testing shall be performed by qualified personnel for proper operation in accordance with all of the latest National Fire Protection Association (NFPA), Underwriters' Laboratories (UL), Underwriters' Laboratories of Canada (ULC), National Electrical Code (NEC), Occupational Safety and Health Administration (OSHA), local, state, county, province, district, federal and other applicable building and fire standards, guidelines, regulations, laws and codes including, but not limited to, all appendices and amendments and the requirements of the local authority having jurisdiction (AHJ). Wheelock products when properly specified, applied, installed, operated, maintained and operationally tested as provided above are warranted against mechanical and electrical defects for a period of three years from date of manufacture (as determined by date code). Correction of defects by repair or replacement shall be at Wheelock's sole discretion and shall constitute fulfillment of all obligations under this warranty. THE FOREGOING LIMITED WARRANTY SHALL IMMEDIATELY TERMINATE IN THE EVENT ANY PART NOT FURNISHED BY WHEELOCK IS INSTALLED IN THE PRODUCT. THE FOREGOING LIMITED WARRANTY SPECIFICALLY EXCLUDES ANY SOFTWARE REQUIRED FOR THE OPERATION OF OR INCLUDED IN A PRODUCT. WHEELOCK MAKES NO REPRESENTATION OR WARRANTY OF ANY OTHER KIND, EXPRESS, IMPLIED OR STATUTORY WHETHER AS TO MERCHANTABILITY, FITNESS FOR A PARTICULAR PURPOSE OR ANY OTHER MATTER.

USERS ARE SOLELY RESPONSIBLE FOR DETERMINING WHETHER A PRODUCT IS SUITABLE FOR THE USER'S PURPOSES, OR WHETHER IT WILL ACHIEVE THE USER'S INTENDED RESULTS. THERE IS NO WARRANTY AGAINST DAMAGE RESULTING FROM MISAPPLICATION, IMPROPER SPECIFICATION, ABUSE, ACCIDENT OR OTHER OPERATING CONDITIONS BEYOND WHEELOCK'S CONTROL.

SOME WHEELOCK PRODUCTS CONTAIN SOFTWARE. WITH RESPECT TO THOSE PRODUCTS, WHEELOCK DOES NOT WARRANT THAT THE OPERATION OF THE SOFTWARE WILL BE UNINTERRUPTED OR ERROR-FREE OR THAT THE SOFTWARE WILL MEET ANY OTHER STANDARD OF PERFORMANCE, OR THAT THE FUNCTIONS OR PERFORMANCE OF THE SOFTWARE WILL MEET THE USER'S REQUIREMENTS. WHEELOCK SHALL NOT BE LIABLE FOR ANY DELAYS, BREAKDOWNS, INTERRUPTIONS, LOSS, DESTRUCTION, ALTERATION, OR OTHER PROBLEMS IN THE USE OF A PRODUCT ARISING OUT OF OR CAUSED BY THE SOFTWARE.

THE LIABILITY OF WHEELOCK ARISING OUT OF THE SUPPLYING OF A PRODUCT, OR ITS USE, WHETHER ON WARRANTIES, NEGLIGENCE, OR OTHERWISE, SHALL NOT IN ANY CASE EXCEED THE COST OF CORRECTING DEFECTS AS STATED IN THE LIMITED WARRANTY AND UPON EXPIRATION OF THE WARRANTY PERIOD ALL SUCH LIABILITY SHALL TERMINATE. WHEELOCK IS NOT LIABLE FOR LABOR COSTS INCURRED IN REMOVAL, REINSTALLATION OR REPAIR OF THE PRODUCT BY ANYONE OTHER THAN WHEELOCK OR FOR DAMAGE OF ANY TYPE WHATSOEVER, INCLUDING BUT NOT LIMITED TO, LOSS OF PROFIT OR INCIDENTAL OR CONSEQUENTIAL DAMAGES. THE FOREGOING SHALL CONSTITUTE THE SOLE REMEDY OF THE PURCHASER AND THE EXCLUSIVE LIABILITY OF WHEELOCK.

IN NO CASE WILL WHEELOCK'S LIABILITY EXCEED THE PURCHASE PRICE PAID FOR A PRODUCT.

Limitation of Liability

WHEELOCK'S LIABILITY ON ANY CLAIM OF ANY KIND, INCLUDING NEGLIGENCE AND BREACH OF WARRANTY, FOR ANY LOSS OR DAMAGE RESULTING FROM, ARISING OUT OF, OR CONNECTED WITH THIS CONTRACT, OR FROM THE MANUFACTURE, SALE, DELIVERY, RESALE, REPAIR OR USE OF ANY PRODUCT COVERED BY THIS ORDER SHALL BE LIMITED TO THE PRICE APPLICABLE TO THE PRODUCT OR PART THEREOF WHICH GIVES RISE TO THE CLAIM. WHEELOCK'S LIABILITY ON ANY CLAIM OF ANY KIND SHALL CEASE IMMEDIATELY UPON THE INSTALLATION IN THE PRODUCT OF ANY PART NOT FURNISHED BY WHEELOCK. IN NO EVENT SHALL WHEELOCK BE LIABLE FOR ANY CLAIM OF ANY KIND UNLESS IT IS PROVEN THAT OUR PRODUCT WAS A DIRECT CAUSE OF SUCH CLAIM. FURTHER, IN NO EVENT, INCLUDING IN THE CASE OF A CLAIM OF NEGLIGENCE, SHALL WHEELOCK BE LIABLE FOR INCIDENTAL OR CONSEQUENTIAL DAMAGES. SOME STATES DO NOT ALLOW THE EXCLUSION OR LIMITATION OF INCIDENTAL OR CONSEQUENTIAL DAMAGES, SO THE PROCEEDING LIMITATION MAY NOT APPLY TO ALL PURCHASERS.