

# PASSIVE INFRARED SENSOR

CE  PA-470L : (WIDE ANGLE / LONG RANGE)

CE  PA-480S : (SUPER WIDE ANGLE)



OPTIONAL:ATTACHMENT BCW-401

## NEW GENERATION WALL MOUNT PASSIVE INFRARED SENSOR

### PA-470L FEATURES

#### QUAD ELEMENT+ NEW FUZZY LOGIC PROCESSING SYSTEM

"Fuzzy Logic" is the state-of-the-art processing system that simulates the human decision process as it compares various information such as size, temperature differential, etc. to determine the criteria for an alarm condition. This reduces false alarm while maintaining a high detection capability.

#### PATTERN SELECTABLE WITH INTERCHANGEABLE LENS

Wide angle / long range pattern is selectable during installation by convenient fresnel lens replacement. Spare long range lens is included in package. Zone changeover switch sets the detection pattern to match the lens pattern when lens is changed.

#### TROUBLE ALARM -LOW VOLTAGE-

When sensor detects a drop in supply voltage,the alarm relay and LED latches in alarm until voltage is restored to its proper level.

#### ALARM MEMORY

Units contain special circuitry to indicate an alarm has been activated during armed period. Especially useful when more than one unit is used per zone.

### REMOTE LED CONTROL

Allows the LED to be enabled/disabled via the control panel.

- \*Alarm LED disable (ON/OFF)
- \*Alarm contact selectable (N.C./N.O.)
- \*Sensitivity adjustment (60%,80%,100%,120%)
- \*Zone changeover (Wide angle/long range)
- \*Anti-creep zone

### PA-480S FEATURES

#### WALL MOUNT 180° COVERAGE

Two twin elements cover 90° each to create a full 180° pattern. Each 90° area can be vertically adjusted up or down to create the required coverage pattern.

#### TROUBLE ALARM -LOW VOLTAGE-

When sensor detects a drop in supply voltage, a trouble alarm is initiated.

- \*Alarm LED disable(ON/OFF)
- \*Signal count selectable(2 signals / 4 signals)
- \*Anti-creep zone

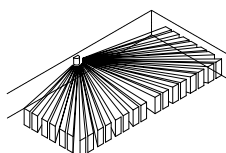

One unit covers two units' area

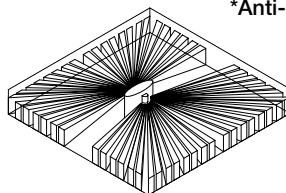

When installed on central pillar, 2 units cover 360° pattern

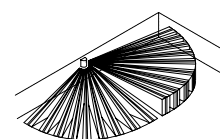

Different coverage by 90° each

# PASSIVE INFRARED SENSOR

## COVERAGE

- PA-470L
- TOP VIEW / WIDE ANGLE

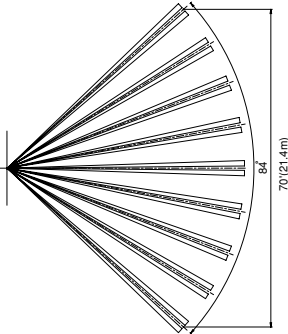

- TOP VIEW / LONG RANGE



- SIDE VIEW / WIDE ANGLE

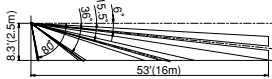

- SIDE VIEW / LONG RANGE

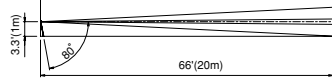

- PA-480S
- TOP VIEW / WIDE ANGLE

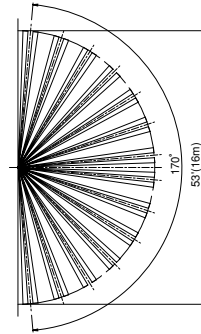

- SIDE VIEW / SUPER WIDE ANGLE



## TERMINAL ARRANGEMENT

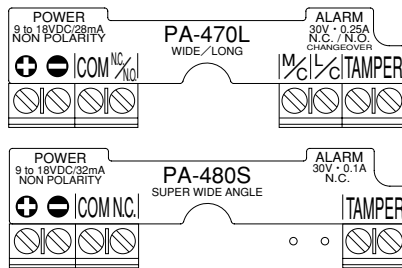

## EXTERNAL DIMENSIONS

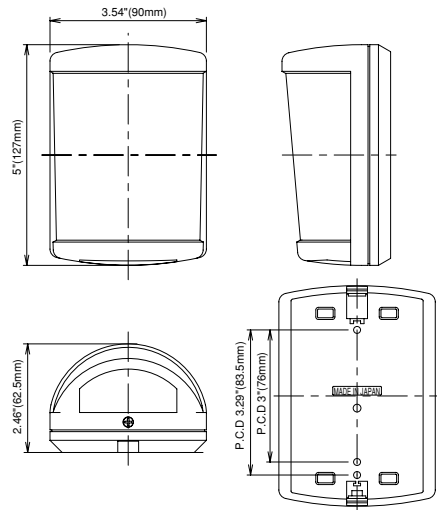

## SPECIFICATIONS

The specifications are subject to change without notice.

Model	PA-470L	PA-480S
Detection	Passive infrared (Quad • Fuzzy logic)	Passive infrared (Twin element • pulse count)
Coverage	Wide angle 53' Max (16m)	Long range 66' Max (20m)
Number of sensitive zone	22 pairs (88)	Super wide angle radius 26' Max (8m)
Mounting positions	Indoor wall / pillar	
Supply voltage	9 to 18 V DC (non-polarity)	
Power consumption	28mA Max	32mA Max
Alarm output	Dry contact relay (N.C./N.O. selectable) Reset : approx. 2sec. 30V • 0.25A Max (protective resistance 3.3Ω built-in)	Dry contact relay (N.C.) Reset : approx. 2 sec. 30V • 0.1A Max (protective resistance 3.3Ω built-in)
Temper output	Dry contact (N.C.) Open when cover is detached 30V • 0.1A Max	
Alarm LED	Red LED Warm up : flickering (every 0.5 sec.) Alarm : solid (approx. 2 sec.) Memory : continuous solid Trouble alarm : continuous solid (LED disable)	Red LED(2) Warm up : flickering (every 0.5 sec.) Alarm : solid (approx. 2 sec.) Memory : continuous solid (LED disable) Trouble alarm : continuous solid (LED disable)
Memory control	Controls memory indication/ reset with terminal M/C	_____
LED control	Controls alarm LED indication with terminal L / C	_____
Trouble alarm	Low power voltage : monitors drop in power voltage Operate : initiate trouble alarm	
Ambient temp. range	+14°F to +122°F (-10°C to +50°C) without condensation	
Wiring	Terminals	
Area adjustment	_____	Downward 5 positions
Weight	5.8oz. (165g)	
Accessory	Fixing screw : 4 × 30 2pcs. Long range lens	Fixing screw : 4 × 30 2pcs. Area lock screw : 3 × 10 1pce.

The passive infrared sensor is designed to detect infrared energy variations caused by the presence of a human body. Therefore, note that similar variations in conditions in protected area, due to other reasons, may cause the sensor to create an alarm as it is unable to distinguish between sources.

**Please Note :** This sensor is designed to detect intrusion and to initiate an alarm; it is not a burglary or a crime preventing device. TAKEX is not responsible for damage, injury or losses caused by accident, theft, Acts of God (including inductive surge by lighting), abuse, misuse, abnormal usage, faulty installation or improper maintenance.

# TAKEX

### In Japan

Takekaka Engineering Co., Ltd.  
83-1, Gojo-sotokan,  
Higashino, Yamashina-ku,  
Kyoto 607-8156, Japan  
Tel : 81-75-501-6651  
Fax : 81-75-593-3816  
<http://www.takekaka-eng.co.jp>

### In the U.S.

Takekaka America Inc.  
1330, Orleans Drive  
Sunnyvale,  
CA 94086, U.S.A.  
Tel : 408-747-0100  
Fax : 408-734-1100  
<http://www.takekaka.com>

### In Australia

Takekaka America Inc.  
Unit 16/35 Garden Road,  
Clayton 3168 Victoria,  
Australia  
Tel : 03-9546-0533  
Fax : 03-9547-9450

Takekaka America Inc.  
Brisbane office : 1/50 Logan  
Road, Woolloongabba  
Queensland  
4102, Australia  
Tel : 07-3891-3344  
Fax : 07-3891-3355

### In the U.K.

Takekaka Europe Ltd.  
Takekaka House, Aviary Court,  
Wade Road, Basingstoke,  
Hampshire, RG24 8PE, U.K.  
Tel : (+44) 01256-475555  
Fax : (+44) 01256-466268  
<http://www.takekacaeurope.com>