

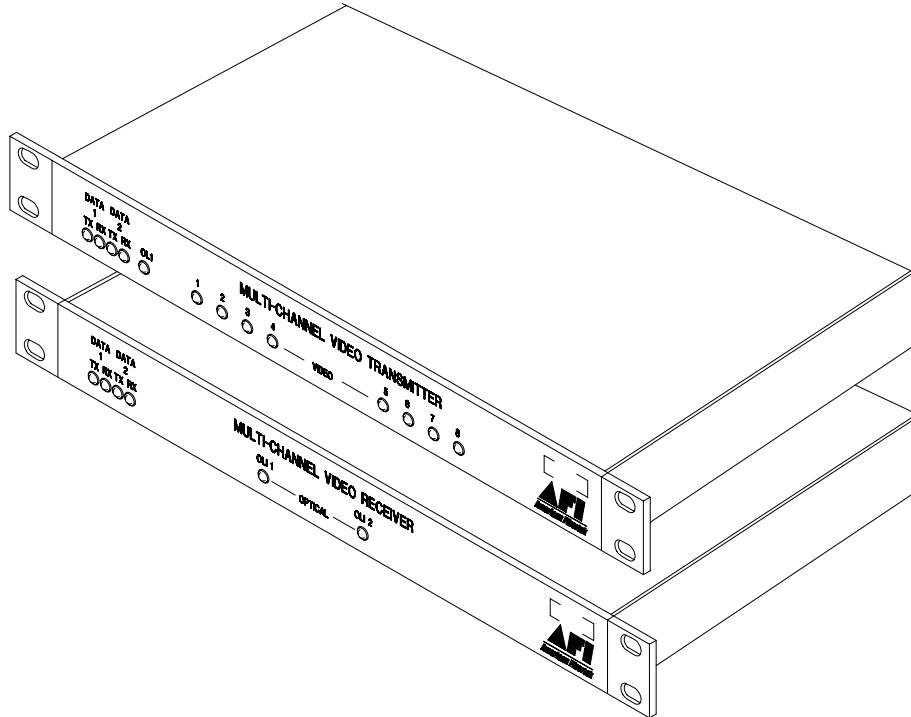

120 Belmont Drive
Somerset, NJ 08873-1204

American Fibertek

Phone: 732.302.0660 Fax: 732.302.0667



Instruction Manual

MTX-8810C-SL

MRX-8810C-SL

Eight Channel Video Multiplexer
with Bi-directional SensorNet Data

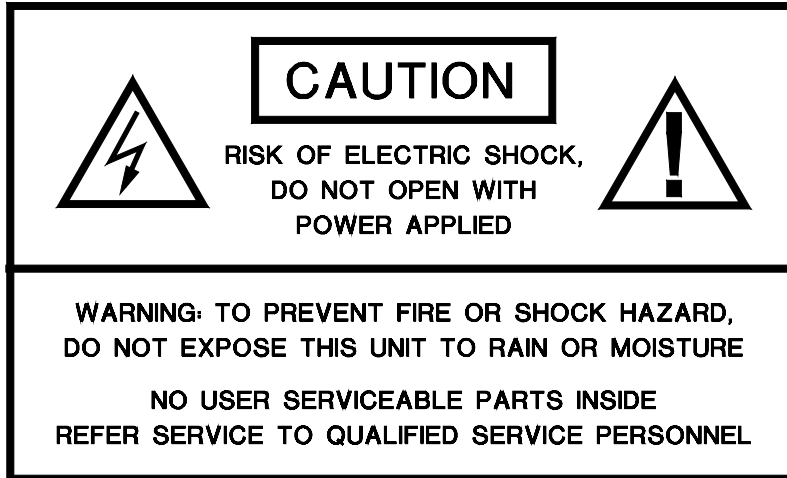

Table of Contents

| | |
|--|---|
| Functional Description | 3 |
| Installation | 3 |
| Power Source | 4 |
| Power Connection | 4 |
| Input / Output Connections..... | 4 |
| Data Configuration | 5 |
| MTX-8810C-SL Status LED Indicators..... | 6 |
| MRX-8810C-SL Status LED Indicators | 7 |
| Warranty..... | 8 |
| Service Information | 8 |

INSTALLATION AND OPERATION INSTRUCTIONS

INTRODUCTION

Thank you for purchasing your American Fibertek Series 8810C-SL singlemode eight channel video multiplexer with bi-directional Sensornet data. Please take a few minutes to read these installation instructions in order to obtain the maximum performance from this product.

FUNCTIONAL DESCRIPTION

The 8810C-SL Series units operate as a transmitter / receiver pair for the transmission of eight simultaneous, real time baseband NTSC / PAL video signals with Sensornet data over one singlemode fiber optic cable.

The MTX-8810C-SL transmitter accepts up to eight video inputs and multiplexes these signals along with the data signals onto a single optical output port for connection to the fiber transmission system. Correspondingly, the MRX-8810C-SL receiver converts the optical signal to eight independent video output signals along with the data signals.

The 8810C-SL Series units operate on 9 um singlemode fiber. Refer to the data sheets for detailed performance specifications.

The individual units may be configured for rack mounting or wall mounting depending upon the position of the included mounting hardware.

INSTALLATION

THIS INSTALLATION SHOULD BE MADE BY A QUALIFIED SERVICE PERSON AND SHOULD CONFORM TO THE NATIONAL ELECTRICAL CODE, ANSI/NFPA 70 AND LOCAL CODES.

To install the MTX-8810C-SL or MRX-8810C-SL it is first necessary to mount the rack flanges to the unit.

For rack mounting the ears are installed on the sides of the unit with the surfaces that have oval holes flush with the front of the unit as in Figure 1. Mount the ears with the #10 flathead screws provided. To mount in the rack cabinet, use mounting screws that are appropriate for the rack cabinet being used.

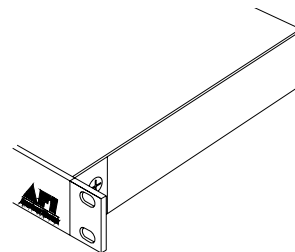

Figure 1. Rack Mount Configuration

For mounting the unit flush to a wall or other rigid surface, the ears may be installed on the sides with the oval holes flush with the bottom of the unit as in Figure 2. Mount the ears with the #10 flathead screws provided. Mount the unit to a rigid surface using #10 (5mm) screws.

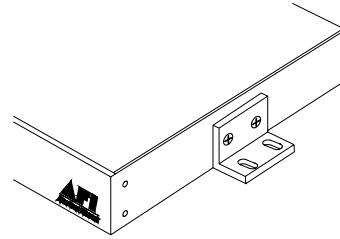

Figure 2. Wall Mount Configuration

POWER SOURCE

The internal power supply accepts universal line voltage. Any mains supply from 100 to 240 VAC, 50 to 60 Hz, may be used without modification or adjustment. A universal power connector is provided on the rear of the unit to facilitate connection to the power mains.

POWER CONNECTION

The unit is supplied (in the US and UK only) with a three conductor power cord. The “ground” conductor is directly connected to the chassis.

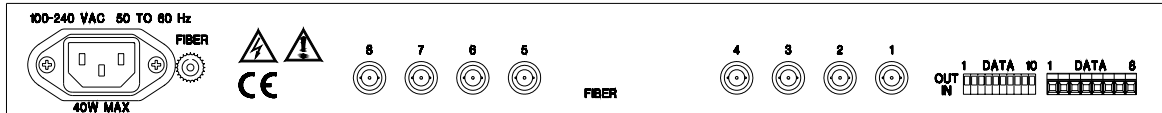

INPUT / OUTPUT CONNECTIONS

The fiber optic connection is made via a FC/PC connector located at the back of the unit. Be sure to allow sufficient room for the required minimum bend radius of the fiber cable used.

Video input and output connections are located on the rear of the unit. A BNC connector is provided for each channel. The video inputs are connected to an appropriate 75Ω baseband video source such as a camera or a video recorder output. The 75Ω video outputs can be looped through typical baseband video inputs of switchers, recorders and other equipment as required. For proper operation, the outputs must be terminated with 75Ω. For optimum performance the video cables should be the shortest length of coax practical.

Data input and output connections are located on the rear panel terminal block. A mating plug connector is provided. The figure below identifies the specific connections for the SensorNet data connections.

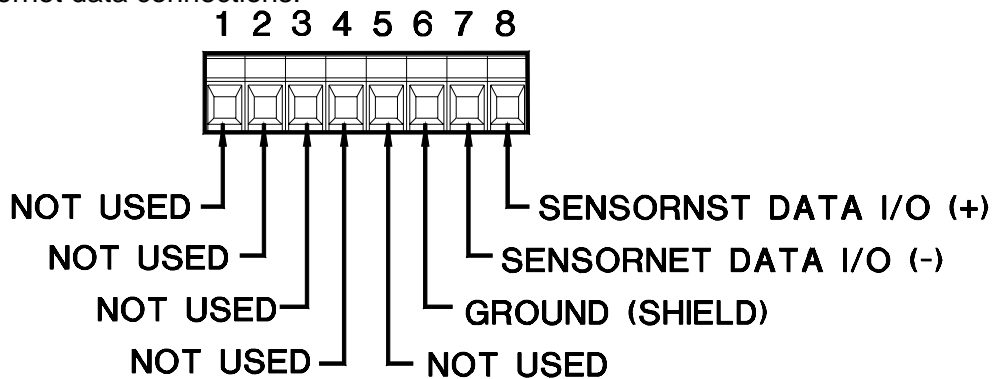

DATA CONFIGURATION

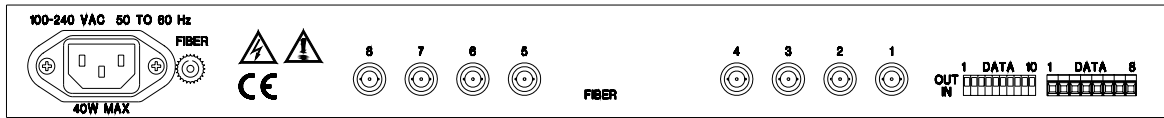

There is a rear panel data configuration switch bank preset at the factory for Sensornet data transmission. With the exception of switch # 5, these switches must remain in the positions shown below to properly transmit Sensornet data. Switch # 5 is used to apply a 120Ω termination resistor across the data I/O connections. **These units are shipped with the data input/output connections unterminated.** Move switch # 5 to the down position if termination is required for your application.

FACTORY SHIPPED SETUP WITH DATA INPUT AND OUTPUT UNTERMINATED (SEE SWITCH NUMBER 5).

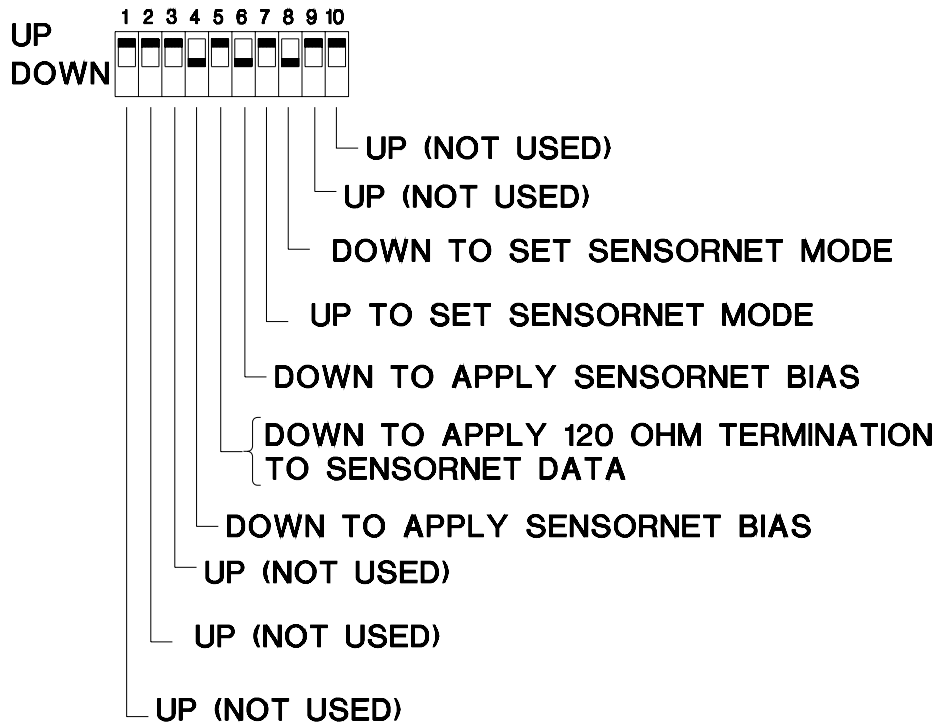

MTX-8810C-SL STATUS INDICATORS

The MTX-8810C-SL transmitter provides the following front panel LED status indicators to aid in installation and troubleshooting:



DATA

These indicators turn green when any data activity is present. An active DATA 1 LED indicates data is present at the input /output terminals of the MTX-8810C-SL. An active DATA 2 LED indicates the MTX-8810C-SL has seized the data carrier to allow data flow. The intensity of the indicators will vary with input / output data patterns, however, the Tx and Rx Carrier Detect LEDs will typically appear dimmer than the Sensornet Tx and Rx LEDs. The data activity associated with these front panel DATA LEDs are listed below.

| DATA 1 TX | DATA 1 RX | DATA 2 TX | DATA 2 RX |
|--------------|--------------|-------------------|-------------------|
| Sensornet Tx | Sensornet Rx | Tx Carrier Detect | Rx Carrier Detect |

OLI

A bi-color LED indicator monitors the optical input power of the data signal that is being received at the MTX-8810C-SL from the MRX-8810C-SL. AC power and optical input status associated with this LED are summarized below.

| Optical Level Indicator | AC Power Status | Optical Status |
|-------------------------|-----------------|------------------------------------|
| Green | On | Proper Optical Input Power Present |
| Red | On | Optical Input Not Detected |
| Off | Off | Check Power Supply Input |

VIDEO

A bi-color LED indicator is provided for each of the eight video channel inputs. AC power and video status associated with each of these LEDs are summarized below.

| Video Presence LED | AC Power Status | Video Status |
|--------------------|-----------------|----------------------------|
| Green | On | Proper Input Video Present |
| Red | On | Input Video Not Detected |
| Off | Off | Check Power Supply Input |

MRX-8810C-SL STATUS INDICATORS

The MRX-8810C-SL receiver provides the following front panel LED status indicators to aid in installation and troubleshooting:



DATA

These indicators turn green when any data activity is present. An active DATA 1 LED indicates data is present at the input /output terminals of the MRX-8810C-SL. An active DATA 2 LED indicates the MRX-8810C-SL has seized the data carrier to allow data flow. The intensity of the indicators will vary with input / output data patterns, however, the Tx and Rx Carrier Detect LEDs will typically appear dimmer than the Sensornet Tx and Rx LEDs. The data activity associated with these front panel DATA LEDs are listed below.

| DATA 1 TX | DATA 1 RX | DATA 2 TX | DATA 2 RX |
|--------------|--------------|-------------------|-------------------|
| Sensornet Tx | Sensornet Rx | Tx Carrier Detect | Rx Carrier Detect |

OLI 1

A bi-color LED indicator monitors the power of the optical input signal that is being received at the MRX-8810C-SL from video channels one through four of the MTX-8810C-SL. AC power and optical input status associated with this LED are summarized below. Please note that data is sent as a subcarrier on channel one's video signal.

| Optical Level Indicator | AC Power Status | Optical Status |
|-------------------------|-----------------|------------------------------------|
| Green | On | Proper Optical Input Power Present |
| Red | On | Optical Input Not Detected |
| Off | Off | Check Power Supply Input |

OLI 2

A bi-color LED indicator monitors the power of the optical input signal that is being received at the MRX-8810C-SL from video channels five through eight of the MTX-8810C-SL. AC power and optical input status associated with this LED are summarized below.

| Optical Level Indicator | AC Power Status | Optical Status |
|-------------------------|-----------------|------------------------------------|
| Green | On | Proper Optical Input Power Present |
| Red | On | Optical Input Not Detected |
| Off | Off | Check Power Supply Input |

**This unit complies with 21 CFR
1040.10 and 1040.11**

LIFETIME WARRANTY INFORMATION

American Fibertek, Inc warrants that at the time of delivery the products delivered will be free of defects in materials and workmanship. Defective products will be repaired or replaced at the exclusive option of American Fibertek. A Return Material Authorization (RMA) number is required to send the products back in case of return. All returns must be shipped prepaid. This warranty is void if the products have been tampered with. This warranty shall be construed in accordance with New Jersey law and the courts of New Jersey shall have exclusive jurisdiction over this contract. **EXCEPT FOR THE FOREGOING WARRANTY, THERE IS NO WARRANTY OF MERCHANTABILITY OR FITNESS FOR A PARTICULAR PURPOSE OR OTHERWISE, EXPRESSED OR IMPLIED, WHICH EXTENDS BEYOND THE WARRANTY SET FORTH IN THIS AGREEMENT.** In any event, American Fibertek will not be responsible or liable for contingent, consequential, or incidental damages. No agreement or understanding, expressed or implied, except as set forth in this warranty, will be binding upon American Fibertek unless in writing, signed by a duly authorized officer of American Fibertek.

SERVICE INFORMATION

There are no user serviceable parts inside the unit.

In the event that service is required to this unit, please direct all inquiries to:

American Fibertek, Inc.
120 Belmont Drive
Somerset, NJ 08873

Phone: (877) 234-7200
Phone: (732) 302-0660
FAX (732) 302-0667

E-mail: techinfo@americanfibertek.com