

110 & 66 Punch Down Tool

PRODUCT SPECIFICATION

Package includes:

- A. Punch Down Tool, 1 pc
- B. 110 Blade, 1 pc
- C. 66 Blade, 1 pc
- D. Blade Cap, 1 pc
- E. Instructions, 1 sheet

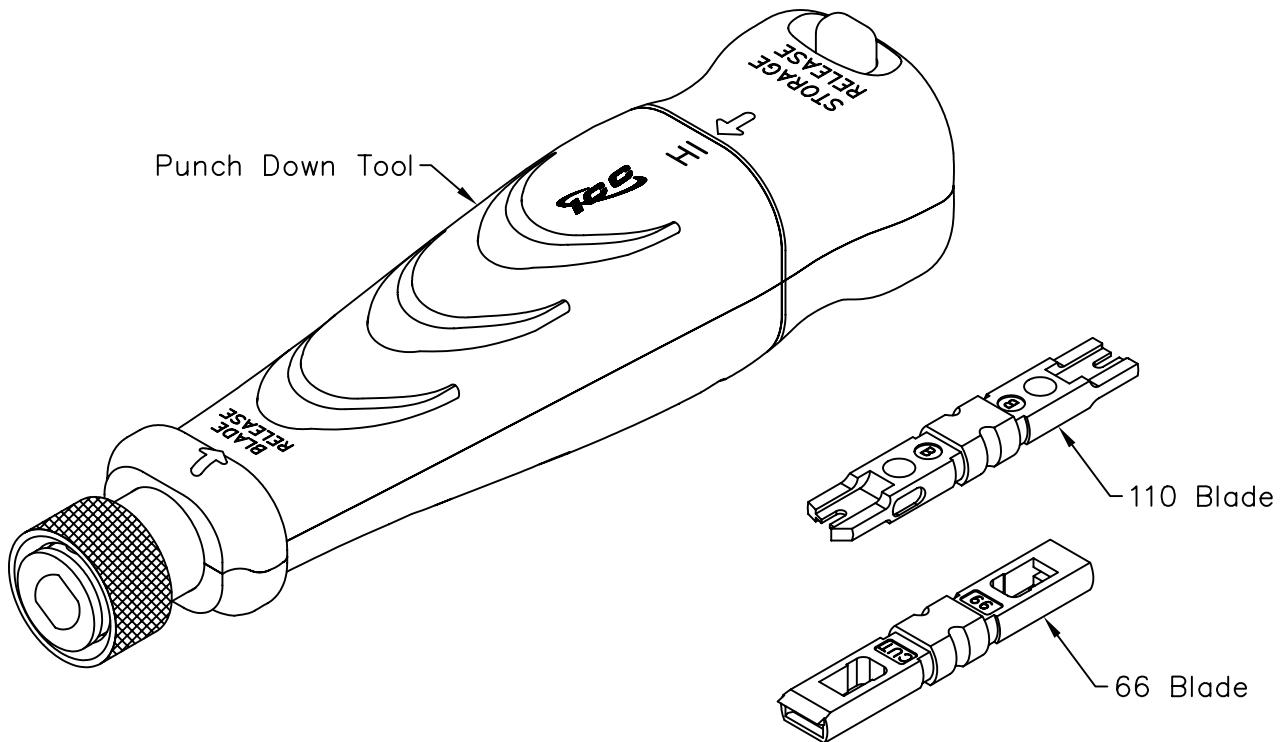

Features and Benefits:

- Designed for both 110 and 66 single-wire termination with both blades included
- Ergonomic design for fast, comfortable, and reliable termination
- High and low impact settings allowing more flexibility during punch down operations
- Low impact setting allows punching down wiring blocks and 110 patch plugs, modules, faceplates, and patch panels with IDC termination, and high impact setting is used when seating 110 connecting blocks into 110 wiring blocks
- Instructions included

TOOL, 110 & 66 PUNCH DOWN, SINGLE BLADE

ITEM NO.	ICACSPDT00	REV.	A
DWG NO.	PSACSPDT00	PAGE NO.	1



CUSTOMER CARE / TECHNICAL SUPPORT * CSR@ICC.COM / 888-ASK-4-ICC (275-4422) * 14700 Alondra Blvd., La Mirada, CA 90638 * www.icc.com

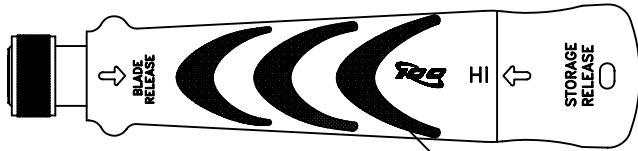

BLUE SIDE

TEXTURED BLACK RUBBER INSERTS

BLUE PUSH BUTTON FOR RELEASE OF BLADE FROM STORAGE

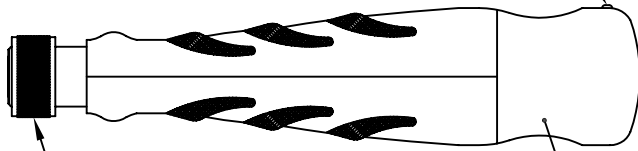

RING LOCK FOR BLADE RETENTION

TEXTURED BLACK RUBBER

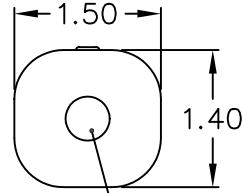

BLADE STORAGE WITH INNER LATCH

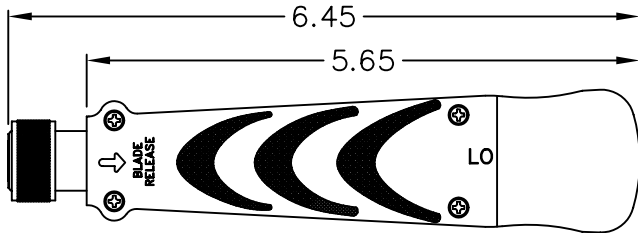

YELLOW SIDE

6.45

5.65

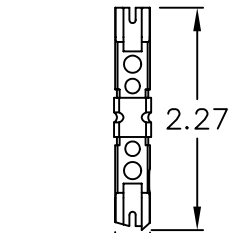

.36

.38

110 BLADE

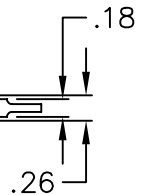

.18

.26

NOTE: UNLESS OTHERWISE SPECIFIED

1. MATERIAL:
 - A. BODY: ABS, FIBER, AND THERMOPLASTIC RUBBER
 - B. NECK: CRS
 - C. BLADE: AISI 4140
2. COLOR:
 - A. BODY: BLUE AND YELLOW
 - B. RUBBER INSERTS: BLACK
 - C. NECK: PLATED BLACK
3. FINISH:
 - A. BODY: MATTED TEXTURE
4. HARDNESS:
 - A. BLADE: HRC 40~52°
5. MECHANICAL:
 - A. LOW IMPACT: 11 KGS (FOR 24 & 26 AWG WIRES)
 - B. HIGH IMPACT: 15 KGS (FOR 22 AWG WIRES)

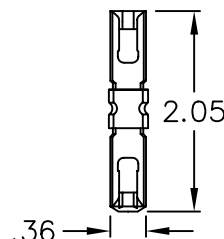

.36

.38

66 BLADE

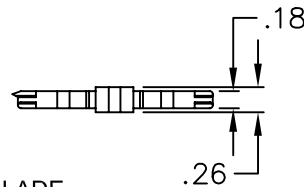

.18

.26

TOOL, 110 & 66 PUNCH DOWN, SINGLE BLADE

ITEM NO.	ICACSPDT00	REV.	A
DWG NO.	PSACSPDT00	PAGE NO.	2



CUSTOMER CARE / TECHNICAL SUPPORT * CSR@ICC.COM / 888-ASK-4-ICC (275-4422) * 14700 Alondra Blvd., La Mirada, CA 90638 * www.icc.com