

8P8C HD Category 5e Module, 25 PK

PRODUCT SPECIFICATION

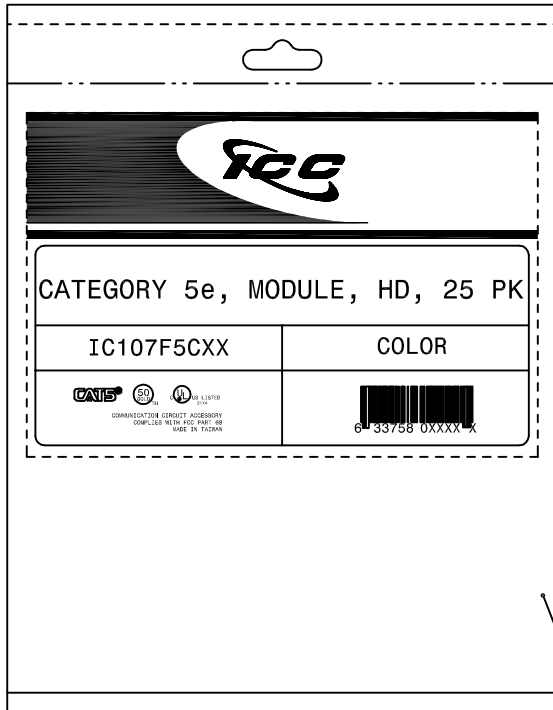

Package includes:

- A. 8P8C HD Category 5e Module, 25 pcs
- B. Wire Cap, 25 pcs

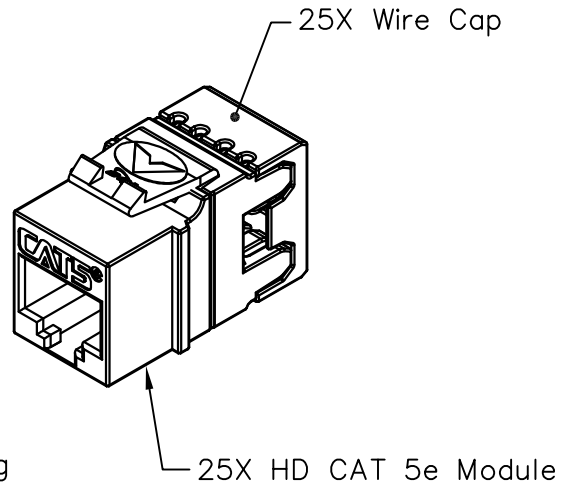

Features and Benefits:

- CAT 5e rated connectors provide excellent performance for data networks requiring maximum speed and bandwidth.
- PCB technology provides maximum performance and superior signal quality.
- Enhanced crosstalk cancellation reduces return loss and improves performance by rejecting noise and unwanted signals.
- Exceeds ANSI/TIA-568-C.2 Category 5e connecting hardware requirements.
- Engineered to provide 110 IDC termination reducing installation time.
- Reduced rear footprint allows for greater connectivity density and provides for more port configurations in a smaller area.
- Includes an integrated TIA-568A/B color wiring diagram.
- Backwards compatible to all lower rated category components.
- Compatible with all IC107 faceplates, inserts, surface mount boxes, and blank patch panels.
- Compatible with all IC108 furniture faceplates, bezels, and surface mount boxes.
- Used with ICC Category 5e ICPCS5 and ICPCS9 series patch cords and 110 punch down tool ICACSPDT00.
- Available in black, blue, ivory, orange, red, and white.
- Installation instructions included.
- UL listed.

MODULE, CAT 5E, HD, 25 PK		 <i>PremiumProducts</i> <i>ProvenPerformance</i> <i>CompetitivePrices</i>	
ITEM NO.	IC107F5CXX		REV. C
DWG NO.	PS107F5C00		PAGE NO. 1

CUSTOMER CARE / TECHNICAL SUPPORT * CSR@ICC.COM / 888-ASK-4-ICC (275-4422) * 14700 Alondra Blvd., La Mirada, CA 90638 * www.icc.com

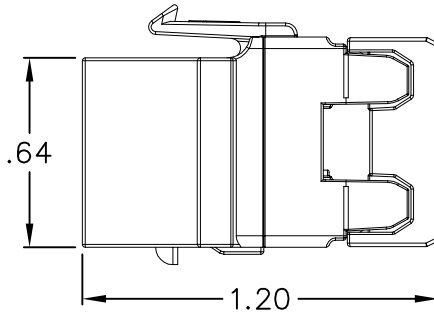
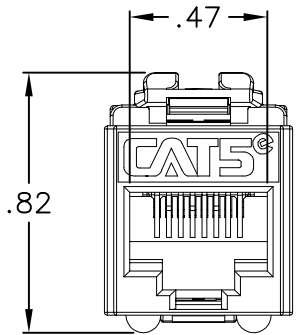
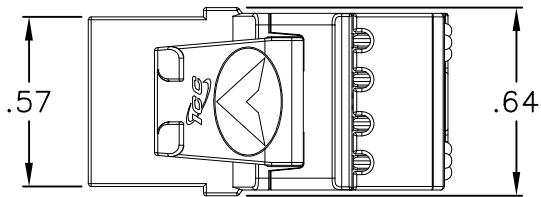

NOTE: UNLESS OTHERWISE SPECIFIED

1. CAT 5E MODULE:

A. ELECTRICAL:

- CURRENT RATING: 1.5 AMPS
- INSULATION RESISTANCE: 500 MOHMS MIN
- CONTACT RESISTANCE: 20 MOHMS MAX
- DC RESISTANCE: 0.1 OHM MAX
- TRANSMISSION PERFORMANCE EXCEEDS CATEGORY 5e CONNECTING HARDWARE REQUIREMENTS SPECIFIED IN ANSI/TIA-568-C.2 WHEN USED WITH COMPATIBLE HORIZONTAL CABLE

B. MECHANICAL:

- PLUG INSERTION LIFE: 750 CYCLES MIN
- PLUG & JACK CONTACT FORCE: 100 GRAMS MIN USING FCC APPROVED PLUG
- PLUG RETENTION FORCE: 30 LBS MIN
- TEMPERATURE: -40°C TO 150° F (-40° TO 68° C)

C. PHYSICALS:

- HOUSING: ABS, UL 94V-0
- JACK WIRING: 50 MICRO INCHES OF GOLD OVER 100 INCHES OF NICKEL
- CONNECTOR: INSULATION DISPLACEMENT CONNECTOR (IDC) ACCEPTS 23~24 AWG SOLID WIRE

D. COLORS: XX-BK-BLACK, BL-BLUE, IV-IVORY, OR-ORANGE, RD-RED, WH-WHITE

2. TERMINATION CAP:

- A. MATERIAL: PC, UL 94V-0
- B. COLOR: TRANSPARENT BLUE

CATEGORY 5e CONNECTING HARDWARE REQUIREMENTS										
FREQUENCY (MHz)	1.0	4.0	8.0	10.0	16.0	20.0	25.0	31.25	62.5	100
NEXT LOSS (db)	65.0	65.0	64.9	63.0	58.9	57.0	55.0	53.1	47.1	43.0
FEXT LOSS (db)	65.0	63.1	57.0	55.1	51.0	49.1	47.1	45.2	39.2	35.1
RETURN LOSS (db)	30.0	30.0	30.0	30.0	30.0	30.0	30.0	30.0	24.1	20.0
INSERTION LOSS(db)	0.10	0.10	0.11	0.13	0.16	0.18	0.20	0.22	0.32	0.40

WIRING DIAGRAM

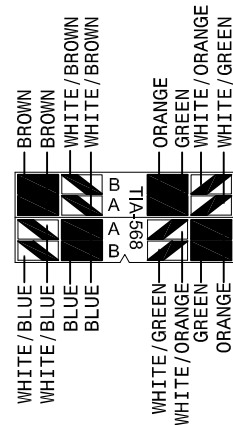

UL US FILE NO. 125268

MODULE, CAT 5E, HD, 25 PK			
ITEM NO.	IC107F5CXX		REV. C
DWG NO.	PS107F5C00		PAGE NO. 2

CUSTOMER CARE / TECHNICAL SUPPORT * CSR@ICC.COM / 888-ASK-4-ICC (275-4422) * 14700 Alondra Blvd., La Mirada, CA 90638 * www.icc.com