



Addressable Fire Alarm Control Panel
MS-9050UD
MS-9050UDC

Document 52413
10/22/2010

Rev: **F**

P/N 52413:F

ECN 10-564

Fire Alarm System Limitations

While a fire alarm system may lower insurance rates, it is not a substitute for fire insurance!

An automatic fire alarm system—typically made up of smoke detectors, heat detectors, manual pull stations, audible warning devices, and a fire alarm control panel with remote notification capability—can provide early warning of a developing fire. Such a system, however, does not assure protection against property damage or loss of life resulting from a fire.

The Manufacturer recommends that smoke and/or heat detectors be located throughout a protected premise following the recommendations of the National Fire Protection Association Standard 72 (NFPA 72), manufacturer's recommendations, State and local codes, and the recommendations contained in the Guides for Proper Use of System Smoke Detectors, which are made available at no charge to all installing dealers. These documents can be found at <http://www.systemsensor.com/html/applicat.html>. A study by the Federal Emergency Management Agency (an agency of the United States government) indicated that smoke detectors may not go off in as many as 35% of all fires. While fire alarm systems are designed to provide early warning against fire, they do not guarantee warning or protection against fire. A fire alarm system may not provide timely or adequate warning, or simply may not function, for a variety of reasons:

Smoke detectors may not sense fire where smoke cannot reach the detectors such as in chimneys, in or behind walls, on roofs, or on the other side of closed doors. Smoke detectors also may not sense a fire on another level or floor of a building. A second-floor detector, for example, may not sense a first-floor or basement fire.

Particles of combustion or "smoke" from a developing fire may not reach the sensing chambers of smoke detectors because:

- Barriers such as closed or partially closed doors, walls, or chimneys may inhibit particle or smoke flow.
- Smoke particles may become "cold," stratify, and not reach the ceiling or upper walls where detectors are located.
- Smoke particles may be blown away from detectors by air outlets.
- Smoke particles may be drawn into air returns before reaching the detector.

The amount of "smoke" present may be insufficient to alarm smoke detectors. Smoke detectors are designed to alarm at various levels of smoke density. If such density levels are not created by a developing fire at the location of detectors, the detectors will not go into alarm.

Smoke detectors, even when working properly, have sensing limitations. Detectors that have photoelectronic sensing chambers tend to detect smoldering fires better than flaming fires, which have little visible smoke. Detectors that have ionizing-type sensing chambers tend to detect fast-flaming fires better than smoldering fires. Because fires develop in different ways and are often unpredictable in their growth, neither type of detector is necessarily best and a given type of detector may not provide adequate warning of a fire.

Smoke detectors cannot be expected to provide adequate warning of fires caused by arson, children playing with matches (especially in bedrooms), smoking in bed, and violent explosions (caused by escaping gas, improper storage of flammable materials, etc.).

Heat detectors do not sense particles of combustion and alarm only when heat on their sensors increases at a predetermined rate or reaches a predetermined level. Rate-of-rise heat detectors may be subject to reduced sensitivity over time. For this reason, the rate-of-rise feature of each detector should be tested at least once per year by a qualified fire protection specialist. Heat detectors are designed to protect property, not life.

IMPORTANT! Smoke detectors must be installed in the same room as the control panel and in rooms used by the system for the connection of alarm transmission wiring, communications, signaling, and/or power. If detectors are not so located, a developing fire may damage the alarm system, crippling its ability to report a fire.

Audible warning devices such as bells may not alert people if these devices are located on the other side of closed or partly open doors or are located on another floor of a building. Any warning device may fail to alert people with a disability or those who have recently consumed drugs, alcohol or medication. Please note that:

- Strobes can, under certain circumstances, cause seizures in people with conditions such as epilepsy.
- Studies have shown that certain people, even when they hear a fire alarm signal, do not respond or comprehend the meaning of the signal. It is the property owner's responsibility to conduct fire drills and other training exercise to make people aware of fire alarm signals and instruct them on the proper reaction to alarm signals.
- In rare instances, the sounding of a warning device can cause temporary or permanent hearing loss.

A fire alarm system will not operate without any electrical power. If AC power fails, the system will operate from standby batteries only for a specified time and only if the batteries have been properly maintained and replaced regularly.

Equipment used in the system may not be technically compatible with the control panel. It is essential to use only equipment listed for service with your control panel.

Telephone lines needed to transmit alarm signals from a premise to a central monitoring station may be out of service or temporarily disabled. For added protection against telephone line failure, backup radio transmission systems are recommended.

The most common cause of fire alarm malfunction is inadequate maintenance. To keep the entire fire alarm system in excellent working order, ongoing maintenance is required per the manufacturer's recommendations, and UL and NFPA standards. At a minimum, the requirements of NFPA 72 shall be followed. Environments with large amounts of dust, dirt or high air velocity require more frequent maintenance. A maintenance agreement should be arranged through the local manufacturer's representative. Maintenance should be scheduled monthly or as required by National and/or local fire codes and should be performed by authorized professional fire alarm installers only. Adequate written records of all inspections should be kept.

Limit-C1-2-2007

Installation Precautions

Adherence to the following will aid in problem-free installation with long-term reliability:

WARNING - Several different sources of power can be connected to the fire alarm control panel. Disconnect all sources of power before servicing. Control unit and associated equipment may be damaged by removing and/or inserting cards, modules, or interconnecting cables while the unit is energized. Do not attempt to install, service, or operate this unit until manuals are read and understood.

CAUTION - System Re-acceptance Test after Software Changes: To ensure proper system operation, this product must be tested in accordance with NFPA 72 after any programming operation or change in site-specific software. Re-acceptance testing is required after any change, addition or deletion of system components, or after any modification, repair or adjustment to system hardware or wiring. All components, circuits, system operations, or software functions known to be affected by a change must be 100% tested. In addition, to ensure that other operations are not inadvertently affected, at least 10% of initiating devices that are not directly affected by the change, up to a maximum of 50 devices, must also be tested and proper system operation verified.

This system meets NFPA requirements for operation at 0-49° C/32-120° F and at a relative humidity 93% ± 2% RH (non-condensing) at 32°C ± 2°C (90°F ± 3°F). However, the useful life of the system's standby batteries and the electronic components may be adversely affected by extreme temperature ranges and humidity. Therefore, it is recommended that this system and its peripherals be installed in an environment with a normal room temperature of 15-27° C/60-80° F.

Verify that wire sizes are adequate for all initiating and indicating device loops. Most devices cannot tolerate more than a 10% I.R. drop from the specified device voltage.

Like all solid state electronic devices, this system may operate erratically or can be damaged when subjected to lightning induced transients. Although no system is completely immune from lightning transients and interference, proper grounding will reduce susceptibility. Overhead or outside aerial wiring is not recommended, due to an increased susceptibility to nearby lightning strikes. Consult with the Technical Services Department if any problems are anticipated or encountered.

Disconnect AC power and batteries prior to removing or inserting circuit boards. Failure to do so can damage circuits.

Remove all electronic assemblies prior to any drilling, filing, reaming, or punching of the enclosure. When possible, make all cable entries from the sides or rear. Before making modifications, verify that they will not interfere with battery, transformer, or printed circuit board location.

Do not tighten screw terminals more than 9 in-lbs. Overtightening may damage threads, resulting in reduced terminal contact pressure and difficulty with screw terminal removal.

This system contains static-sensitive components. Always ground yourself with a proper wrist strap before handling any circuits so that static charges are removed from the body. Use static suppressive packaging to protect electronic assemblies removed from the unit.

Follow the instructions in the installation, operating, and programming manuals. These instructions must be followed to avoid damage to the control panel and associated equipment. FACP operation and reliability depend upon proper installation.

Precau-D1-9-2005

FCC Warning

WARNING: This equipment generates, uses, and can radiate radio frequency energy and if not installed and used in accordance with the instruction manual may cause interference to radio communications. It has been tested and found to comply with the limits for class A computing devices pursuant to Subpart B of Part 15 of FCC Rules, which is designed to provide reasonable protection against such interference when devices are operated in a commercial environment. Operation of this equipment in a residential area is likely to cause interference, in which case the user will be required to correct the interference at his or her own expense.

Canadian Requirements

This digital apparatus does not exceed the Class A limits for radiation noise emissions from digital apparatus set out in the Radio Interference Regulations of the Canadian Department of Communications.

Le present appareil numerique n'emet pas de bruits radioelectriques depassant les limites applicables aux appareils numeriques de la classe A prescrites dans le Reglement sur le brouillage radioelectrique edicte par le ministere des Communications du Canada.

LiteSpeed™ is a trademark; and FireLite® Alarms is a registered trademark of Honeywell International Inc. Microsoft® and Windows® are registered trademarks of the Microsoft Corporation.

©Thursday, August 16, 2012 2:14 pm by Honeywell International Inc. All rights reserved. Unauthorized use of this document is strictly prohibited.

Software Downloads

In order to supply the latest features and functionality in fire alarm and life safety technology to our customers, we make frequent upgrades to the embedded software in our products. To ensure that you are installing and programming the latest features, we strongly recommend that you download the most current version of software for each product prior to commissioning any system. Contact Technical Support with any questions about software and the appropriate version for a specific application.

Documentation Feedback

Your feedback helps us keep our documentation up-to-date and accurate. If you have any comments or suggestions about our online Help or printed manuals, you can email us.

Please include the following information:

- Product name and version number (if applicable)
- Printed manual or online Help
- Topic Title (for online Help)
- Page number (for printed manual)
- Brief description of content you think should be improved or corrected
- Your suggestion for how to correct/improve documentation

Send email messages to:

FireSystems.TechPubs@honeywell.com

Please note this email address is for documentation feedback only. If you have any technical issues, please contact Technical Services.

Table of Contents

Section 1: Product Description	12
1.1: Features and Options	12
1.2: Specifications.....	14
1.3: Controls and Indicators.....	15
1.4: Circuits.....	16
1.5: Digital Alarm Communicator/Transmitter	17
1.6: Components	17
1.6.1: Intelligent Addressable Detectors: Newer Series	18
1.6.2: Intelligent Addressable Modules: Newer Series	18
1.6.3: 300 Series Intelligent Addressable Devices	18
1.6.4: Device Accessories.....	18
1.7: Optional Modules and Accessories	19
1.8: Getting Started	21
1.9: Telephone Requirements and Warnings.....	21
1.9.1: Telephone Circuitry	21
1.9.2: Digital Communicator	21
1.9.3: Telephone Company Rights and Warnings	22
1.9.4: For Canadian Applications	22
Section 2: Installation.....	24
2.1: Mounting Backbox	24
2.2: Mounting Chassis/Transformer/Main Circuit Board	25
2.3: Power	28
2.3.1: AC Power and Earth Ground Connection	28
2.3.2: Battery Power	28
2.4: Relays	29
2.5: Notification Appliance Circuits.....	30
2.5.1: Configuring NACs.....	30
2.6: UL Power-limited Wiring Requirements.....	31
2.7: Digital Communicator	31
2.8: Optional Modules/Accessories Installation	33
2.8.1: 4XTMF Transmitter Module Installation	33
2.8.2: ANN-SEC Option Card.....	35
2.9: ANN-BUS Devices.....	36
Guidelines.....	36
2.9.1: ANN-BUS Wiring	36
Calculating Wiring Distance for ANN-BUS Modules.....	37
Wiring Configuration	39
Powering ANN-BUS Devices from Auxiliary Power Supply	39
2.9.2: ANN-BUS Device Addressing.....	40
2.9.3: ANN-80(C) Remote Fire Annunciator/Indicator	40
Specifications	40
Installation.....	40
Opening/Closing Annunciator.....	40
Mounting	41
Wiring ANN-80 to FACP.....	41
2.9.4: ANN-S/PG Serial/Parallel Interface Module	43
Specifications	44
PRN-6F Printer Installation.....	44
2.9.5: ANN-I/O LED Driver Module	45
ANN-I/O Board Layout.....	45
Specifications	45
ANN-I/O Connection to FACP	46
ANN-I/O Module LED Wiring	46

2.9.6: ANN-LED Annunciator Module	48
Specifications.....	48
Mounting and Installation.....	48
ANN-LED Board Layout and Connection to FACP	49
2.9.7: ANN-RLY Relay Module.....	49
Specifications.....	49
Mounting and Installation.....	50
ANN-RLY Board Layout and Connection to FACP.....	51
Section 3: Programming	52
3.1: Programming Data Entry	52
3.2: User Programming	53
3.3: Initial Power-up.....	54
3.4: Programming Screens Description	54
3.5: Programming and Passwords.....	54
3.6: Master Programming Level	56
3.6.1: Autoprogram	57
3.6.2: Point Program	57
Detector Programming.....	58
Module Programming.....	68
3.6.3: Zone Setup	85
Enable	85
Disable	86
Zone 17, 18, and 19	86
Zones Installed.....	87
Zones Enabled	87
Zones Disabled	87
Zone Type.....	88
Zones Available	89
3.6.4: Loop Setup.....	89
Style	89
Loop Protocol	90
3.6.5: System Setup	90
Trouble Reminder.....	91
Banner.....	91
Time-Date	93
Timers.....	95
NAC (Notification Appliance Circuit)	97
Relays	103
Canadian Option	104
Waterflow Silenceable.....	104
3.6.6: Verify Loop	105
3.6.7: History	105
View Events.....	105
Erase History	106
3.6.8: Walktest	106
3.6.9: Option Modules	108
ANN-BUS.....	108
Onboard DACT	120
3.6.10: Password Change.....	136
3.6.11: Clear Program.....	137
3.6.12: Program Check	138
3.7: Maintenance Programming Level.....	139
3.7.1: Disable Point.....	140
3.7.2: History	141
3.7.3: Program Check	142
3.7.4: Walktest	143

3.7.5: System	144
3.7.6: Zone Setup	145
Section 4: Operating Instructions	148
4.1: Panel Control Buttons	148
4.1.1: Acknowledge/Step	148
4.1.2: Alarm Silence	148
4.1.3: Drill/Hold 2 Sec	148
4.1.4: Reset	148
4.2: Status Indicators and LEDs	148
4.3: Normal Operation	149
4.4: Trouble Operation	150
4.5: Alarm Operation	151
4.6: Supervisory Operation	152
4.7: Process Monitor Operation	153
4.8: Hazard/Tornado Condition Operation	153
4.9: Medical Alert Condition Operation	154
4.10: NAC Operation	154
4.11: Programmed Zone Operation	154
4.12: Disable/Enable Operation	155
4.13: Waterflow Circuits Operation	155
4.14: Detector Functions	155
4.15: Time Functions: Real-Time Clock	155
4.16: Synchronized NAC Operation	155
4.17: Coded Operation	156
4.18: Presignal	156
4.19: Positive Alarm Sequence	156
4.20: Special System Timers	157
4.20.1: Silence Inhibit Timer	157
4.20.2: Autosilence Timer	157
4.20.3: Trouble Reminder	157
4.20.4: Waterflow Retard Timer	158
4.20.5: Alarm Verification (None or One Minute)	158
4.21: Walktest	158
4.22: Read Status	159
4.22.1: System Point	160
4.22.2: Zones	162
4.22.3: Power	162
4.22.4: Trouble Reminder	163
4.22.5: Timers	163
4.22.6: NAC	164
4.22.7: Relays	164
4.22.8: Program Check	165
4.22.9: History	165
4.22.10: ANN-BUS	166
4.22.11: Phone Line	167
4.22.12: Central Station	167
4.22.13: Service Terminal	168
4.22.14: Print	168
4.22.15: Time-Date	170
Section 5: Central Station Communications	172
5.1: Transmittal Priorities	175
Section 6: Local/Remote Site Upload/Download	177
6.1: Remote Download	177
6.2: Transferring a Program	178
6.3: Security Features	179

Section 7: Power Supply Calculations	180
7.1: Overview	180
7.2: Calculating the AC Branch Circuit	180
7.3: Calculating the System Current Draw	181
7.3.1: Overview	181
7.3.2: How to Use Table 7.3 on page 182 to Calculate System Current Draw	181
7.4: Calculating the Battery Size	183
7.4.1: NFPA Battery Requirements	183
7.4.2: Selecting and Locating Batteries	183
Appendix A: Software Zones	184
A.1: Correlations	184
Appendix B: Default Programming	189
Appendix C: NFPA Standard-Specific Requirements	191
C.1: Central Station/Remote Station Transmitter: Connection to FACP Dry Contacts	195
C.2: MBT-1 Municipal Box Trip - Silenceable	196
Appendix D: FACP with Keltron	198
Appendix E: Wire Requirements	199
E.1: NAC Wiring	200
Appendix F: HVAC Control	201
F.1: Control Module Operation	201
F.1.1: HVAC SHUTDN	201
F.2: Monitor Module Operation	201
F.2.1: HVAC RESTART	201
F.2.2: HVAC OVERRIDE	202
Appendix G: Ademco Contact ID Format Event Code Descriptions	203
G.1: Transmission Format Between DACT and Receiver	203
G.2: Ademco Contact ID Typical Printout	203
Appendix H: Canadian Application	208
H.1: ANN-LED Annunciator Installation for Canadian Applications	208
H.2: AC Power Connections for Canadian Applications	211
Index	213

It is imperative that the installer understand the requirements of the Authority Having Jurisdiction (AHJ) and be familiar with the standards set forth by the following regulatory agencies:

- Underwriters Laboratories Standards
- NFPA 72 National Fire Alarm Code
- CAN/ULC - S527-99 Standard for Control Units for Fire Alarm Systems

Before proceeding, the installer should be familiar with the following documents.



NFPA Standards

NFPA 72 National Fire Alarm Code
NFPA 70 National Electrical Code



Underwriters Laboratories Documents:

UL 38 Manually Actuated Signaling Boxes
UL 217 Smoke Detectors, Single and Multiple Station
UL 228 Door Closers–Holders for Fire Protective Signaling Systems
UL 268 Smoke Detectors for Fire Protective Signaling Systems
UL 268A Smoke Detectors for Duct Applications
UL 346 Waterflow Indicators for Fire Protective Signaling Systems
UL 464 Audible Signaling Appliances
UL 521 Heat Detectors for Fire Protective Signaling Systems
UL 864 Standard for Control Units for Fire Protective Signaling Systems
UL 1481 Power Supplies for Fire Protective Signaling Systems
UL 1610 Central Station Burglar Alarm Units
UL 1638 Visual Signaling Appliances
UL 1971 Signaling Devices for Hearing Impaired
UL 2017 General-Purpose Signaling Devices and System



CAN/ULC - S524-01 Standard for Installation of Fire Alarm System
CAN/ULC - S561-03 Installation and Services for Fire Signal Receiving Centers and Systems
CAN/ULC - S527-99 Standard for Control Units for Fire Alarm Systems
CAN/ULC - S559-04 Equipment for Fire Signal Receiving Centers and Systems
This Class (A) digital apparatus complies with Canadian ICES-003.
Cet appareil numérique de la classe (A) est conforme à la norme NMB-003 du Canada.

Other:

Canadian Electrical Code, Part I
EIA-232E Serial Interface Standard
EIA-485 Serial Interface Standard
NEC Article 250 Grounding
NEC Article 300 Wiring Methods
NEC Article 760 Fire Protective Signaling Systems
Applicable Local and State Building Codes
Requirements of the Local Authority Having Jurisdiction (LAHJ)

Fire-Lite Documents:

Fire-Lite Device Compatibility	Document #15384
SLC Wiring Manual	Document #51309
CHG-120F Battery Charger	Document #50888
CHG-75 Battery Charger	Document #51315
ANN-80(C) Product Installation Doc.	Document #52749
ANN-(R)LED Product Installation Doc.	Document #53032
ANN-I/O Product Installation Doc.	Document #151416
ANN-RLY Product Installation Doc.	Document #53033
ANN-S/PG Product Installation Doc.	Document #151417

This product has been certified to comply with the requirements in the Standard for Control Units and Accessories for Fire Alarm Systems, UL 864, 9th Edition. Operation of this product with products not tested for UL 864, 9th Edition has not been evaluated. Such operation requires the approval of the local Authority Having Jurisdiction (AHJ).

BASIC SYSTEM CONNECTIONS

Notification Appliance Circuits

Special Application Power
NAC #1 shown Style Y (Class B) (Power-limited, Class 2, Supervised)
NAC #2 shown Style Z (Class A) (Power-limited, Class 2, Supervised)
2.5 amps max. per circuit. Total available current is 2.5 amps.

ELR-4.7, 1/2W

NAC #1

NAC #2

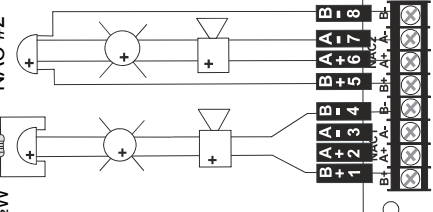

SLC Loop

Refer to the SLC Wiring Manual for detailed information on wiring addressable devices for Style 4, 6, and 7. (Power-limited, Class 2, Supervised Circuit)

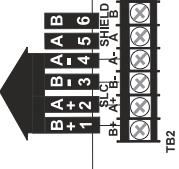

EIA-232 to personal computer

personal computer with FACP Upload/Download utility, 50 foot maximum within same room. (Nonsupervised, Power-limited, Class 2 Circuit)

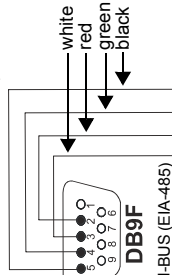

2 Programmable Relays & 1 Fixed Trouble Relay

Nonsupervised Contact Ratings:
2.0 amps @ 30 VDC (resistive)
0.5 amp @ 30 VAC (resistive)

Contacts shown below in normal condition (AC power with no alarm, trouble, or supervisory activity).

A Fail Safe Trouble relay switches to the NO position during trouble conditions and under loss of all power.

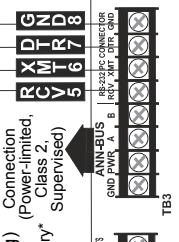
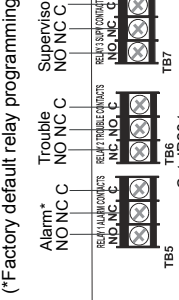

For specific UL wiring information, refer to "UL Power-limited Wiring Requirements" on page 31.

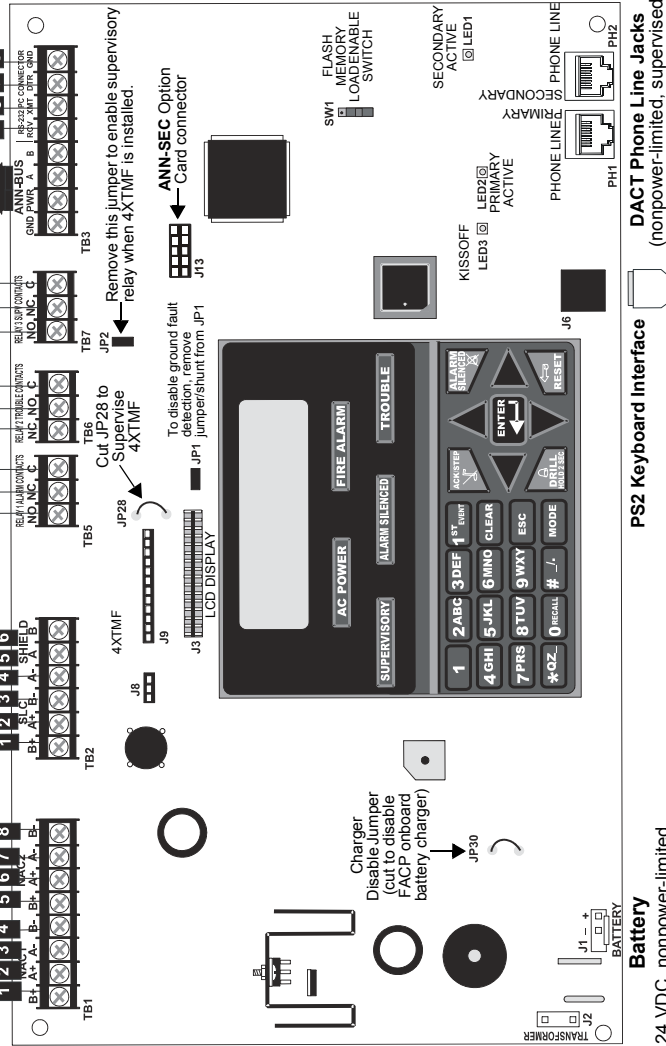

Remove this jumper to enable supervisory relay when 4XTMF is installed.

To disable ground fault supervision, cut JP1 jumper/shunt from JP1

To disable ground fault supervision, cut JP28 to Supervise

ANN-SEC Option Card connector

Remove this jumper to enable supervisory relay when 4XTMF is installed.

ANN-SEC Option Card connector

Remove this jumper to enable supervisory relay when 4XTMF is installed.

To disable ground fault supervision, cut JP1 jumper/shunt from JP1

To disable ground fault supervision, cut JP28 to Supervise

ANN-SEC Option Card connector

Remove this jumper to enable supervisory relay when 4XTMF is installed.

To disable ground fault supervision, cut JP1 jumper/shunt from JP1

To disable ground fault supervision, cut JP28 to Supervise

ANN-SEC Option Card connector

Remove this jumper to enable supervisory relay when 4XTMF is installed.

To disable ground fault supervision, cut JP1 jumper/shunt from JP1

To disable ground fault supervision, cut JP28 to Supervise

ANN-SEC Option Card connector

Peripheral Devices

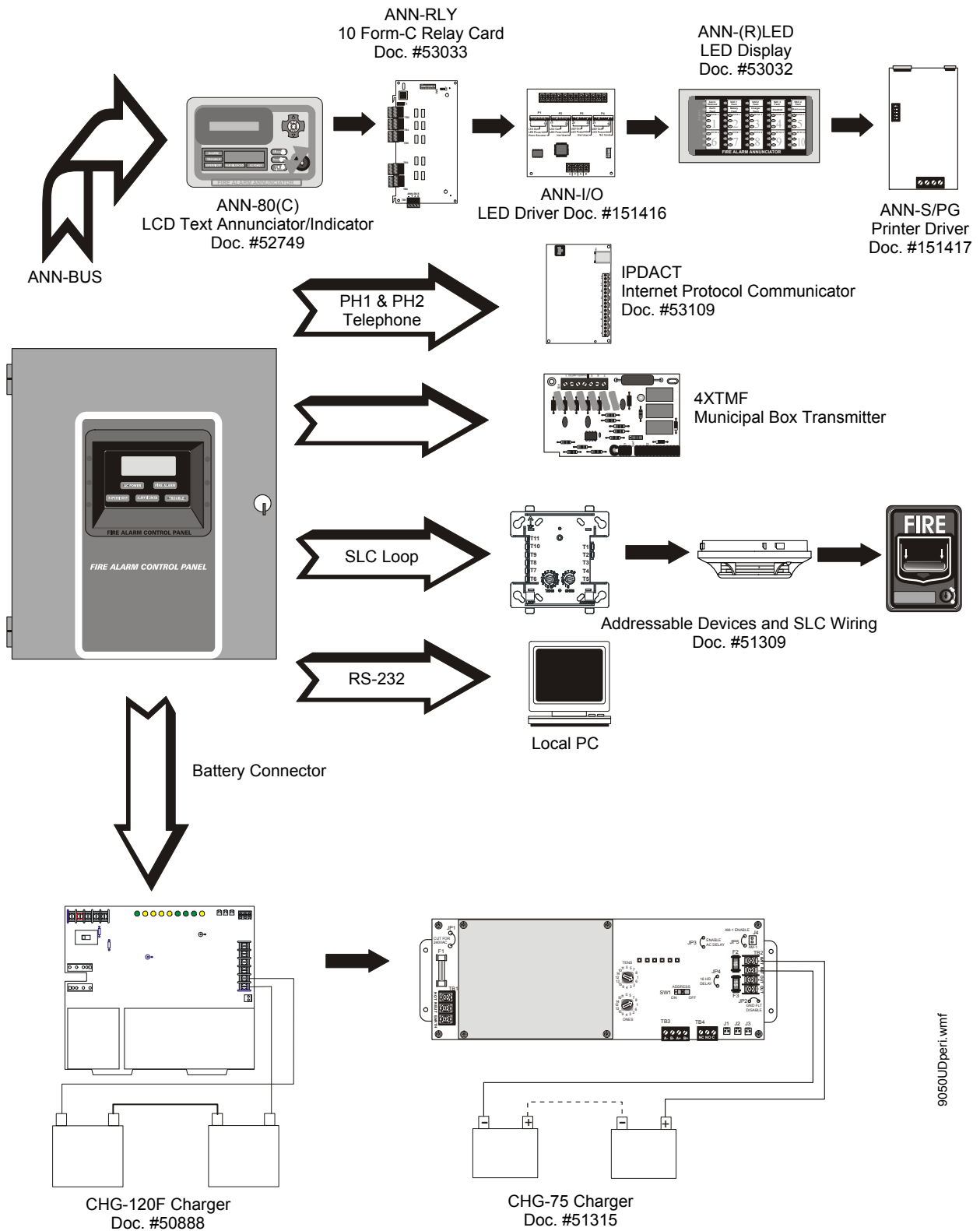

9050UDperi.wmf

Section 1: Product Description

The MS-9050UD is a combination FACP (Fire Alarm Control Panel) and DACT (Digital Alarm Communicator/Transmitter) all on one circuit board. This compact, cost effective, intelligent addressable control panel has an extensive list of powerful features. The combination of Fire-Lite's newer series devices and legacy 300 Series devices, along with the MS-9050UD FACP, offer the latest in fire protection technology. The power supply and all electronics are contained on a single circuit board housed in a metal cabinet, providing a complete fire control system for most applications. Available accessories include local and remote upload/download software, remote annunciators and reverse polarity/city box transmitter.

The integral DACT transmits system status (alarms, troubles, AC loss, etc.) to a Central Station via the public switched telephone network. It also allows remote programming or interrogation of the control panel using the PS-Tools Upload/Download utility via the public switched telephone network. Any personal computer with Windows[®] XP or newer, and compatible modem with a speed of 2400 baud or faster and Upload/Download software kit PK-CD, containing PS-Tools, may serve as a Service Terminal. This allows download of the entire program or upload of the entire program, history file, walktest data and current status.

The MS-9050UDC is a ULC-approved Canadian version of the FACP which offers the same features as the MS-9050UD, but is supplied standard with a dress panel and one built-in ANN-LED annunciator. Refer to "Canadian Option" on page 104 for a full description.

The MS-9050UDE offers the same features as the MS-9050UD but allows connection to 220/240 VAC power.



NOTE: Unless otherwise specified, the terms FACP and MS-9050UD are used in this manual to refer to all versions of the FACPs.

Inventory

When the MS-9050UD shipment is received, check to make certain that all parts have been included in the shipment. The MS-9050UD shipment should consist of one of each of the following:

- ✓ main circuit board with display
- ✓ chassis with transformer
- ✓ backbox with door
- ✓ plastic bag containing screws, cables, key, etc.
- ✓ manual

1.1 Features and Options

- Built-in DACT (Digital Alarm Communicator/Transmitter) with remote upload/download
- Single addressable SLC loop which meets NFPA Style 4, 6 and 7 requirements
- 50 addressable device capacity (any combination of addressable detectors and addressable control/relay/monitor modules totalling 50)
- 20 software zones
- Two onboard NACs (Notification Appliance Circuits) which can be configured as Style Y (Class B) or Style Z (Class A) circuits
- 2.5 amps total output power
- Two programmable relays and one fixed trouble relay
- Built-in Programmer
- Telephone Line Active LEDs

- Communication Confirmation (*Kissoff*) LED
- Touchtone/Rotary dialing
- EIA-232 PC interface for local upload/download
- 80-character LCD display (backlit)
- Real-time clock/calendar with daylight savings time control
- History file with 500 event capacity
- Advanced fire technology features:
 - ✓ Automatic drift compensation
 - ✓ Maintenance alert
 - ✓ Detector sensitivity test capability (NFPA 72 compliant)
 - ✓ Automatic device type-code verification
 - ✓ Point trouble identification
- Waterflow selection per module point
- Alarm verification selection per detector point
- Walktest, silent or audible
- PAS (Positive Alarm Sequence) per addressable detector and Pre-signal per point (NFPA 72 compliant)
- Silence inhibit timer option per NAC
- Autosilence timer option per NAC
- Continuous, March Time, Temporal or California code for main circuit board NACs with two-stage capability
- Selectable strobe synchronization per NAC
- Remote Acknowledge, Alarm Silence, Reset and Drill via addressable modules or remote annunciator
- Auto-program (learn mode) reduces installation time. Reports two devices set to the same address
- Password and key-protected nonvolatile memory
- User programmable password
- Fully programmable from local keypad or optional keyboard
- SLC operates up to 10,000 ft. (3,000 m) with twisted, unshielded fire wire
- Compatible with Fire-Lite addressable devices (refer to the *SLC Wiring Manual*)
- Compatible with legacy Fire-Lite 300 Series addressable devices (refer to the *SLC Wiring Manual*)
- Optional 4XTMF module (conventional reverse polarity/city box transmitter)
- Optional ANN-I/O LED Driver module
- Optional ANN-S/PG printer interface module
- Optional ANN-80 remote LCD annunciator
- Optional ANN-80C remote LCD indicator (for Canadian applications)
- Optional ANN-LED Annunciator Module annunciates alarm, trouble and supervisory
- Optional ANN-RLED Annunciator Module annunciates alarms only
- Optional ANN-RLY Form-C Relay Module
- Optional Dress Panel DP-51050 (a modified dress panel with the ANN-LED is included standard with the MS-9050UDC)
- Optional PRN-6F Serial Printer (requires ANN-S/PG module)
- Optional PK-CD (contains PS-Tools) for local/remote upload/download of programming and data

1.2 Specifications

Refer to Illustration on page 10 for terminal locations and connections. For wire specifications, refer to “Wire Requirements” on page 199.

AC Power - Transformer Connection

MS-9050UD: 120 VAC, 60 Hz, 3.0 amps

MS-9050UDE: 240 VAC, 50 Hz, 1.5 amps

Wire size: minimum 14 AWG (2.00 mm²) with 600 V insulation

Nonpower-limited, supervised

Battery (Lead Acid Only) - J1

Maximum Charging Circuit: Normal Flat Charge - 27.4 VDC @ 4.3 amps peak inrush current tapering to a maximum of 2.8 amps of continuous charging current.

Maximum Battery Charger Capacity: 18 Amp Hour, (FACP cabinet holds maximum of two 18 Amp Hour batteries)

For greater than 18 Amp Hour up to 120 Amp Hour batteries, use the CHG-75 or CHG-120F Battery Charger and BB-26 or BB-55F Battery Box, respectively.

Jumper JP30 on the FACP main circuit board, must be removed to disable the FACP battery charger when using an external battery charger.

Minimum Battery: 7 Amp Hour

Nonpower-limited, supervised

SLC Communication Loop - TB2

24 VDC nominal, 27.6 VDC maximum

Maximum length is 10,000 ft. (3,000 m) total twisted, unshielded fire wire

Maximum loop current is 400 mA (short circuit) or 100 mA (normal)

Maximum loop resistance is 40 ohms

Supervised and power-limited circuit

Refer to SLC Loop manual for wiring information

Notification Appliance Circuits/Special Application (Auxiliary) Power - TB1

Terminal Block provides connections for up to two NACs, Style Y (Class B) or Style Z (Class A)

Special Application power

Power-limited, supervised circuitry

For wire specifications, refer to “NAC Wiring” on page 200.

Nominal operating voltage: 24 VDC

Current-limit: fuseless, electronic, power-limited circuitry

Maximum signaling current per circuit: 2.5 amps for NACs, 1.0 amp for auxiliary power and door holders

End-of-Line Resistor: 4.7 K Ω , ½ watt (P/N 71252 UL listed) for Style Y (Class B) NAC

Refer to the *Fire-Lite Device Compatibility Document* for listed compatible devices

A circuit programmed for door holders or auxiliary power does not support notification appliances.

Two Programmable Relays and One Fixed Trouble Relay - TB5, TB6 & TB7

Contact rating: 2.0 amps @ 30 VDC (resistive), 0.5 amps @ 30 VAC (resistive)

Form-C relays, nonpower-limited, nonsupervised

Refer to Figure 2.5 on page 29 for information on power-limited relay circuit wiring

EIA-232 - TB3

EIA-232 PC applications connections: Terminal 5 (Receive), 6 (Transmit), 7 (DTR), 8 (Ground)

Power-limited, supervised

Special Application Primary ANN-BUS Power - TB3

Nominal Operating Voltage: 24 VDC
 Maximum Current (Terminals 1 & 2): 500 mA
 Power-limited, supervised

Special Application Secondary ANN-BUS Power - ANN-SEC - TB1

Nominal Operating Voltage: 24 VDC
 Maximum Current (Terminals 1 & 2): 500 mA
 Power-limited, supervised

The following figure illustrates the maximum current that is possible for each major panel output circuit and the total current available from the FACP.

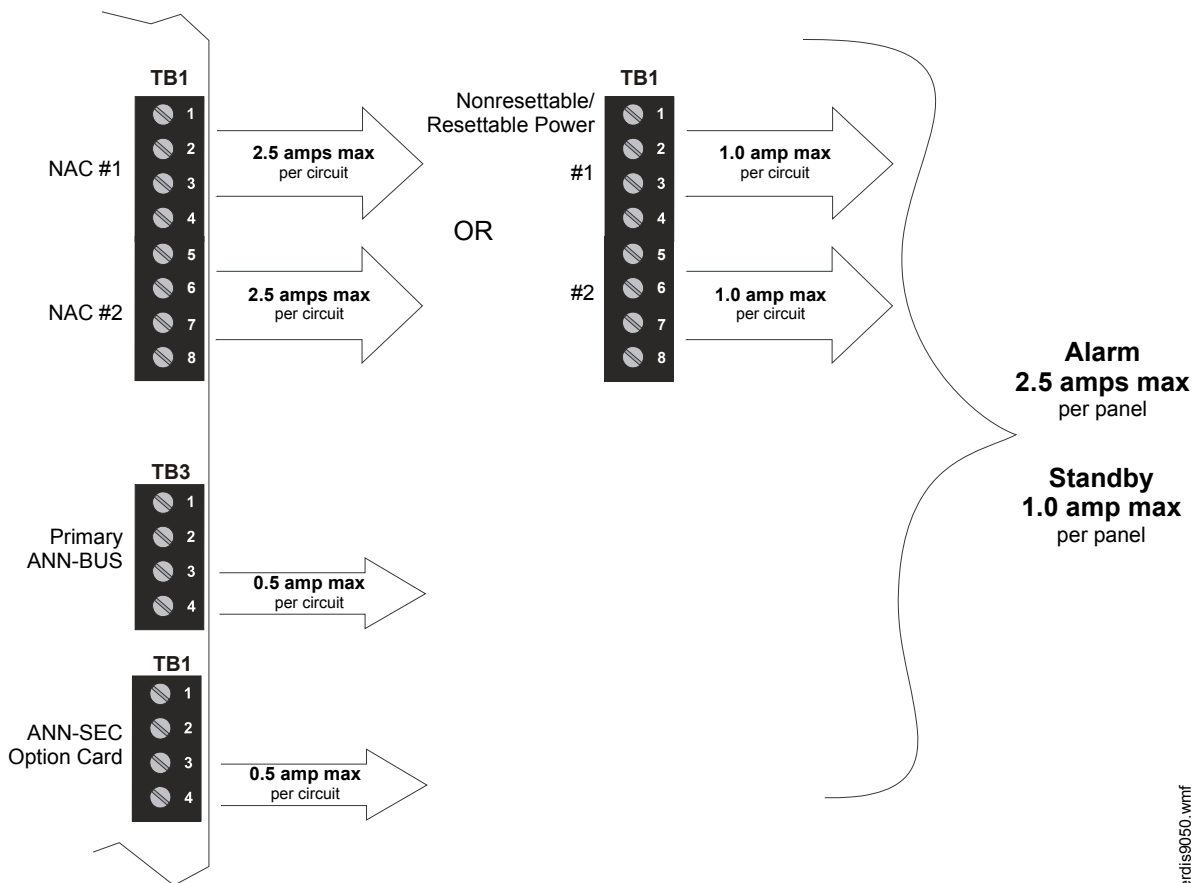

Refer to the battery calculations section for additional information.

Figure 1.1 Current Availability

1.3 Controls and Indicators

LCD Display

The FACP uses an 80-character (4 lines X 20 characters) high viewing angle LCD display. The display includes a long life LED backlight that remains illuminated. If AC power is lost and the system is not in alarm, the LED backlight will turn off to conserve batteries.



LED Indicators

LED indicators are provided to annunciate the following conditions:

- AC Power (green)
- Fire Alarm (red)
- Supervisory (yellow)
- Trouble (yellow)
- Alarm Silenced signals (yellow)

Key Panel

Mounted on the main circuit board, the key panel includes a window for the LCD display and LED indicators as listed above. The key panel, which is visible with the cabinet door closed, has 25 keys, including a 16 key alpha-numeric pad similar to a telephone keypad.

Function keys:

- Acknowledge/Step
- Alarm Silenced
- Drill (Manual Evacuate)
- Reset (lamp test)

Service/program keys:

- Keys labeled 1 to 9
- * key
- # key
- 0 (recall) key
- 1st Event key
- Clear key
- Escape key
- Mode key
- Four cursor keys (up, down, left and right)
- Enter key



Figure 1.2 Membrane/Display Panel

Local Piezo Sounder

A piezo sounder provides separate and distinct pulse rates for alarm, trouble and supervisory conditions.

1.4 Circuits

SLC Communication Loop

One SLC loop is provided on the FACP main circuit board. The SLC loop, configurable for NFPA Style 4, 6 or 7, provides communication to addressable detectors, monitor (initiating device) and control (output device) modules. Refer to the *SLC Wiring manual* for information on wiring devices.

Output Circuits

The following output circuits are available on the FACP:

- Charger - 24 VDC Battery Charger (up to 18 AH batteries)
- NAC (Notification Appliance Circuits) - Two NACs configurable for Style Y (Class B) or Style Z (Class A), are provided with various programmable features.

Relays

One fixed and two fully programmable Form-C dry contact relays are provided. The fixed fail-safe relay monitors system trouble and the two programmable relays are factory default programmed for system alarm and system supervisory. Contacts are rated 2.0 amps @ 30 VDC (resistive) and 0.5 amps @ 30 VAC (resistive). The programmable relays can be programmed for the following operations:

- fire alarm
- silenceable alarm
- trouble
- supervisory
- supervisory auto-resettable
- DACT communication failure
- process monitor
- process monitor auto-resettable
- hazard alert
- medical alert
- AC loss

1.5 Digital Alarm Communicator/Transmitter

Two modular phone jacks allow easy connection to telephone lines. Modular jacks are labeled PH1 for Primary Phone Line and PH2 for Secondary Phone Line. Two telephone line active red LEDs are provided as well as a green *Kissoff* LED. The integral digital communicator provides the following functions:

- Line Seizure: takes control of the phone lines disconnecting any premises phones
- Off/On Hook: performs on and off-hook status to the phone lines
- Dialing the Central Station(s) number: default is Touch-Tone®, programmable to rotary
- For tone burst or touchtone type formats: discern proper *Ack* and *Kissoff* tone(s). The frequency and time duration of the tone(s) varies with the transmission format. The control panel will adjust accordingly.
- Communicate in the following formats:
 - ✓ 12 Tone Burst types: 20 pps
(3+1, 4+1, 4+2, 3+1 Exp., 4+1 Exp., 4+2 Exp.)
 - ✓ 3 Touchtone Types
4+1 Ademco Express
4+2 Ademco Express
Ademco Contact ID

1.6 Components

Main Circuit Board

The main circuit board contains the system's CPU, power supply, other primary components and wiring interface connectors. The 4XTMF option module plugs in and is mounted to the main circuit board. The circuit board is delivered mounted to a chassis in the MS-9050UD backbox (refer to circuit board illustration on page 10).

Cabinet

The MS-9050UD backbox provides space for two batteries (up to 18 Amp Hour). Ample knockouts are provided for system wiring. Also available is an optional dress panel, which mounts to the inside of the cabinet (required by ULC for Canadian installations).

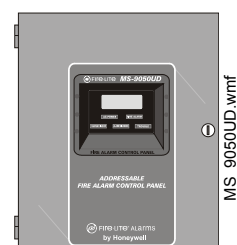

Batteries

The MS-9050UD cabinet provides space for two batteries (up to 18 Amp Hour). Batteries larger than 18 Amp Hour require an external charger such as the CHG-75 or CHG-120F and a UL listed battery box such as the BB-55F. Batteries must be ordered separately.

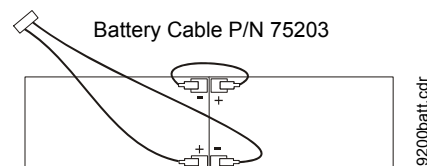

1.6.1 Intelligent Addressable Detectors: Newer Series

Intelligent, addressable detectors provide information to the control panel on an SLC Signaling Line Circuit (refer to the *SLC Wiring Manual* for detailed information on addressable devices, device installation, wiring and operation). This allows the control panel to continually process the information to determine the status (alarm, trouble, maintenance or normal) of each detector. Each detector responds to an SLC address that is set in the detector head using built-in rotary decimal switches. Note that a blinking LED on an intelligent detector indicates communication between the detector and the control panel. Refer to the Fire-Lite Device Compatibility Document for a list of approved conventional detectors.

1.6.2 Intelligent Addressable Modules: Newer Series

The newer series of Control Modules and Monitor Modules provide an interface between the control panel and conventional notification and initiating devices. Each module can be set to respond to an address with built-in rotary switches. A blinking LED on a monitor module indicates communication between the module and the control panel. These devices can also be used when installed on older systems. Refer to the *SLC Wiring Manual* for information on addressable devices. Refer to the *Fire-Lite Device Compatibility Document* for a list of approved conventional notification and initiating devices.

1.6.3 300 Series Intelligent Addressable Devices

Fire-Lite's 300 Series Intelligent Addressable Devices are fully compatible with the MS-9050UD FACP. Refer to the *SLC Wiring Manual* for device information.

1.6.4 Device Accessories

End-of-Line Resistor Assembly

Refer to the *SLC Wiring Manual* for device information. The 47 K Ω End-of-Line Resistor assembly (P/N: R-47K) is used to supervise the MMF-300, MDF-300, MMF-301 and CMF-300 module circuits. The 3.9 K Ω End-of-Line Resistor assembly is used to supervise the MMF-302 module circuit. The End-of-Line resistors are included with each module.

Power Supervision Relay

The UL-listed End-of-Line power supervision relay is used to supervise the power to 4-wire smoke detectors and notification appliances.

EOL-C(R/W) Mounting Plate

The EOL-CR (red) and EOL-CW (white) are single End-of-Line resistor plates which are required for use in Canada. An ELR, which is supplied with each module and fire alarm control panel, is mounted to the EOL-C(R/W) plate. Resistors mounted to the plate can be used for the supervision of a monitor and control module circuit.

1.7 Optional Modules and Accessories

The MS-9050UD main circuit board includes option module connectors for the following module:

4XTMF Transmitter Module

The 4XTMF provides a supervised output for local energy municipal box transmitter, alarm and trouble reverse polarity. It includes a disable switch and disable trouble LED. A jumper on the module is used to select an option which allows the reverse polarity circuit to open with a system trouble condition if no alarm condition exists. The module plugs into connectors J8 and J9 which are located near the top center of the main circuit board. When the 4XTMF module is installed, Jumper JP28, on the main circuit board, must be cut to allow supervision of the module.

ANN-80 LCD Annunciator

The ANN-80 is a remote LCD annunciator which mimics the information displayed on the FACP LCD display and provides remote RESET, SILENCE, ACKNOWLEDGE, and DRILL.

ANN-80C LCD Indicator (Canadian applications)

The ANN-80C is a remote LCD indicator which mimics the information displayed on the FACP LCD display but does *not* allow remote control of the FACP.

ANN-LED Annunciator Module

The ANN-LED Annunciator Module provides three LEDs for each zone: Alarm, Trouble and Supervisory. An ANN-LED module is installed in the dress panel for the Canadian version.

ANN-RLY Relay Module

The ANN-RLY Module, which can be mounted inside the cabinet, provides 10 Form-C relays.

ANN-S/PG Serial/Parallel Printer Gateway

The ANN-S/PG module provides a connection for a serial or parallel printer.

ANN-I/O LED Driver Module

The ANN-I/O module provides connections to a user supplied graphic annunciator.

ANN-SEC Secondary ANN-BUS Module

The ANN-SEC module provides another ANN-BUS port for more wiring flexibility and for Canadian applications requiring remote annunciation.

DP-51050 Dress Panel

A dress panel DP-51050 is available as an option. The dress panel restricts access to the system wiring while allowing access to the membrane switch panel. The Canadian version is supplied standard with a modified dress panel.

TR-CE Trim-ring

A trim-ring TR-CE is available as an option. The trim-ring allows semi-flush mounting of the cabinet.

Battery Boxes

BB-26

The BB-26 battery box may be used to house up to two 26 AH batteries and the CHG-75 Battery Charger. The battery box, which is red and is provided with knockouts, was designed specifically to compliment mounting below the FACP.

BB-55F

The BB-55F battery box may be used to house two 26 AH batteries, two 60 AH batteries or one 100 AH battery. When the CHG-120F is mounted in the BB-55F, two 26 AH or one 60 AH battery may also be housed in the battery box.

PS-Tools Programming Utility

The PS-Tools Programming Utility can be used to locally or remotely program an MS-9050UD directly from most IBM compatible personal computers (PC), running Windows[®] XP (or newer). MS-9050UD program files can also be created and stored on the PC and then downloaded to the control panel. The part number PK-CD Kit includes the Windows-based Programming Utility software on CD-ROM with online help file. A serial cable (P/N: PRT/PK-CABLE), which must be purchased separately, is required for local connection of the PC to the RS-232 (PC/Printer) terminals at TB3 of the MS-9050UD main circuit board. Remote programming requires that the PC have a 2400 baud (or faster) modem.

Important: Remote modification of FACP programming requires that the panel be enabled for remote download (refer to “Remote Download” on page 177). Remote interrogation of panel programming, history logs, detector status, etc., is possible without enabling the remote download option.

Battery Chargers

CHG-75 Battery Charger

The CHG-75 is capable of charging up to 75 AH lead-acid batteries with the FACP. The FACP battery charger must be disabled, by removing jumper JP30, when using the CHG-75. The charger and up to 26 AH batteries can be housed in the BB-26 battery box. Larger batteries and the charger can be housed in the BB-55F battery box which can be mounted up to 20 feet away from the control panel. *Refer to the CHG-75 Manual for additional information.*

CHG-120F Battery Charger

The CHG-120F is capable of charging up to 120 AH lead-acid batteries with the FACP. The FACP battery charger must be disabled, by removing jumper JP30, when using the CHG-120F. The batteries and charger can be housed in the BB-55F battery box which can be mounted up to 20 feet away from the control panel. Note that when using the BB-55F for housing the charger and batteries greater than 26AH, multiple BB-55Fs are required. *Refer to the CHG-120F Manual for additional information.*

IPDACT, IPDACT-2, IPDACT-2UD - IP Communicator

The IPDACT, IPDACT-2, and IPDACT-2UD are a compact, Internet Protocol Communicators designed to allow FACP status communication to a Central Station via the internet. No telephone lines are required when using any IPDACT. Using Contact ID protocol from the FACP, any IPDACT converts the standard DACT phone communication to a protocol that can be transmitted and received via the internet. It also checks connectivity between the FACP and Central Station. *Refer to the IPDACT Series Product Installation Document P/N 53109 for additional information.*

1.8 Getting Started

The following is a brief summary of the minimal steps involved in bringing an MS-9050UD on-line:

- Install Backbox and Main Circuit Board (refer to “Mounting Backbox” on page 24).
- Address and Install Intelligent Devices (refer to the SLC Wiring Manual).
- Enter Autoprogramming (refer to “Autoprogram” on page 57).
- Resolve Programming Conflicts.
- Go to Point Program to Enter Specific Data (refer to “Point Program” on page 57). Use the right and left arrow keys to navigate between devices.

1.9 Telephone Requirements and Warnings

1.9.1 Telephone Circuitry

AC Ringer Equivalence Number (REN) = 03B
DC Ringer Equivalence Number (REN) = 0.0B
AC Impedance: 10.0 Mega Ohm
Complies with FCC Part 68
Mates with RJ31X Male Connector
Supervision Threshold: loss of phone line voltage for 2 minutes

The REN is used to determine the quantity of devices which may be connected to the telephone line. Excessive RENs on the telephone line may result in the devices not ringing in response to an incoming call. In most, but not all areas, the sum of the RENs should not exceed five (5.0). To be certain of the number of devices that may be connected to the line as determined by the total RENs, contact the telephone company to determine the maximum REN for the calling area.

1.9.2 Digital Communicator

Before connecting the control panel to the public switched telephone network, the installation of two RJ31X jacks is necessary. If trouble is experienced with this equipment, for repair or warranty information, please contact:

Manufacturer: Fire•Lite Alarms, Inc.
One Fire-Lite Place
Northford, CT 06472
(203) 484-7161

Product Model Number: **MS-9050UD**
FCC Registration Number: **US:1W6AL03B9050UD**
AC Ringer Equivalence: **0.3B**
DC Ringer Equivalence: **0.0B**

*This equipment complies with Part 68 of the FCC rules and the requirements adopted by the ACTA. On the inside of the FACP door is a label that contains, among other information, a product identifier in the format **US:AAAEQ##TXXXX**. If requested, this number must be provided to the telephone company.*

Alarm dialing equipment must be able to seize the telephone line and place a call in an emergency situation. It must be able to do this even if other equipment (telephone, answering system, computer modem, etc.) already has the telephone line in use. To do so, alarm dialing equipment must be connected to a properly installed RJ31X jack that is electrically in series with and ahead of all other equipment attached to the same telephone line. If there are any questions concerning these

instructions, consult the telephone company or a qualified installer about installing the RJ31X jack and alarm dialing equipment. Refer to “Digital Communicator” on page 31 for an illustration of the proper installation of this equipment.

Important! The DACT must not be used to dial a phone number that is call-forwarded.

1.9.3 Telephone Company Rights and Warnings

The telephone company, under certain circumstances, may temporarily discontinue services and/or make changes in its facilities, services, equipment or procedures which may affect the operation of this control panel. However, the telephone company is required to give advance notice of such changes or interruptions.

If the control panel causes harm to the telephone network, the telephone company reserves the right to temporarily discontinue service. Advance notification will be provided except in cases when advance notice is not practical. In such cases, notification will be provided as soon as possible. The opportunity will be given to correct any problems and to file a complaint with the FCC if you believe it is necessary.

DO NOT CONNECT THIS PRODUCT TO COIN TELEPHONE, GROUND START, OR PARTY LINE SERVICES.

When the control panel activates, premise phones will be disconnected.

Two separate phone lines are required. Do not connect both telephone interfaces to the same telephone line.

The control panel must be connected to the public switched telephone network upstream (as first device) of any private telephone system at the protected premises.

A plug and jack used to connect this equipment to the premises wiring and telephone network must comply with the applicable FCC Part 68 rules and requirements adopted by ACTA. This equipment is designed to be connected to the telephone network or premises wiring using a compliant RJ31X male modular plug and compatible modular jack that is also compliant.

1.9.4 For Canadian Applications

The following is excerpted from CP-01 Issue 5:

NOTICE: The Industry Canada (IC) label identifies certified equipment. This certification means that the equipment meets certain telecommunications network protective, operational and safety requirements as prescribed in the appropriate Terminal Equipment Technical Requirements document(s). The Department does not guarantee the equipment will operate to the users's satisfaction.

Before installing this equipment, users should ensure that it is permissible to be connected to the facilities of the local telecommunications company. The equipment must also be installed using an acceptable method of connection. The customer should be aware that compliance with the above conditions may not prevent degradation of service in some situations.

Repairs to certified equipment should be made by an authorized Canadian maintenance facility designated by the supplier. Any repairs or alterations made by the user to this equipment, or equipment malfunctions, may give the telecommunications company cause to request the user to disconnect the equipment.

Users should ensure, for their own protection, that the electrical ground connections of the power utility, telephone lines and internal metallic water pipe system, if present, are connected together. This precaution may be particularly important in rural areas.

CAUTION

Users should not attempt to make such connections themselves, but should contact the appropriate electric inspections authority, or electrician.

“The Ringer Equivalence Number (REN) assigned to each terminal device provides an indication of the maximum number of terminals allowed to be connected to a telephone interface. the termination of an interface may consist of any combination of devices subject only to the requirement that the sum of the REN of all devices does not exceed 5.”

DOC Compliance - “This digital apparatus does not exceed the Class A limits for radio noise emissions from digital apparatus set out in the Radio Interference Regulations of the Canadian Department of Communications.”

Representative: NOTIFIER/FIRE•LITE, CANADA
10 Whitmore Road
Woodbridge, Ontario L4L 7Z4
Phone: (905) 856-8733
FAX: (905) 856-9687

IC Certificate Number: 2132A-9050UD
Ringer Equivalence Number (REN): 0.3B

Section 2: Installation

The cabinet may be either semi-flush or surface mounted. The cabinet mounts using two key slots and two 0.250" (6.35 mm) diameter holes located in the backbox. The key slots are located at the top of the backbox and the two securing holes at the bottom.

Carefully unpack the system and check for shipping damage. Mount the cabinet in a clean, dry, vibration-free area where extreme temperatures are not encountered. The area should be readily accessible with sufficient room to easily install and maintain the panel. Locate the top of the cabinet approximately 5 feet (1.5 m) above the floor with the hinge mounting on the left. Determine the number of conductors required for the devices to be installed. Sufficient knockouts are provided for wiring convenience. Select the appropriate knockout(s) and pull the conductors into the box. All wiring should be in accordance with the National and/or Local codes for fire alarm systems.

2.1 Mounting Backbox

The circuit board contains static-sensitive components. Always ground yourself with a proper wrist strap before handling any boards so that static charges are removed from the body. Use static suppressive packaging to protect electronic assemblies.

To prevent damage to the circuit board and to facilitate backbox mounting, the chassis with main circuit board and transformer can be easily removed. Loosen the two 3/8" nuts securing the top flanges of the chassis, then slide the chassis up to free it from the lower tabs. Place the chassis assembly in a safe location until it can be reinstalled in the backbox.

- ✓ Mark and predrill hole in the wall for the center top keyhole mounting bolt using the dimensions illustrated in Figure 2.3 on page 26.
- ✓ Install center top fastener in the wall with the screw head protruding.
- ✓ Place backbox over the top screw, level, and secure.
- ✓ Mark and drill the left and right upper and lower mounting holes.
Note: outer holes (closest to sidewall) are used for 16" O.C. stud mounting.
- ✓ Install remaining fasteners and tighten.

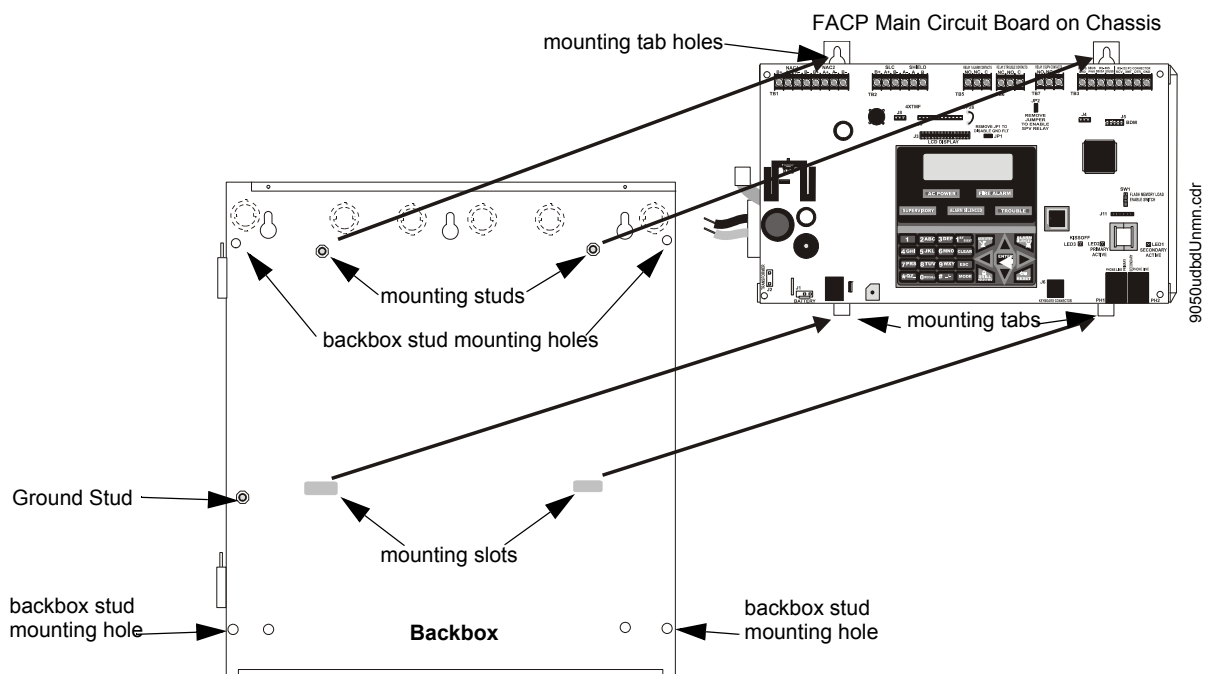

Figure 2.1 Chassis Removal

2.2 Mounting Chassis/Transformer/Main Circuit Board

One transformer is supplied standard with the control panel. Install the transformer and chassis in the location indicated in the following illustration.

1. When the location is dry and free of construction dust, install the chassis/transformer/circuit board assembly.
2. Mount the chassis to the backbox by aligning the two mounting tabs with the slots in the backbox, then position the two mounting hole tabs over the studs with nuts located in the upper portion of the backbox.
3. Slide the tabs located on the bottom of the chassis into the mounting slots in the backbox by pressing the chassis down.
4. Secure the chassis to the backbox by tightening the two mounting nuts (#10-32) at the top, and to ensure proper grounding, use a 3/8" nut driver or socket.
5. If the main circuit board is not already attached to the chassis, install it by positioning the ten mounting holes over the studs on the chassis and secure with the supplied screws.
6. Ensure the transformer plug is connected to Connector J2 on the FACP main circuit board
7. Complete the installation as detailed in the following sections.

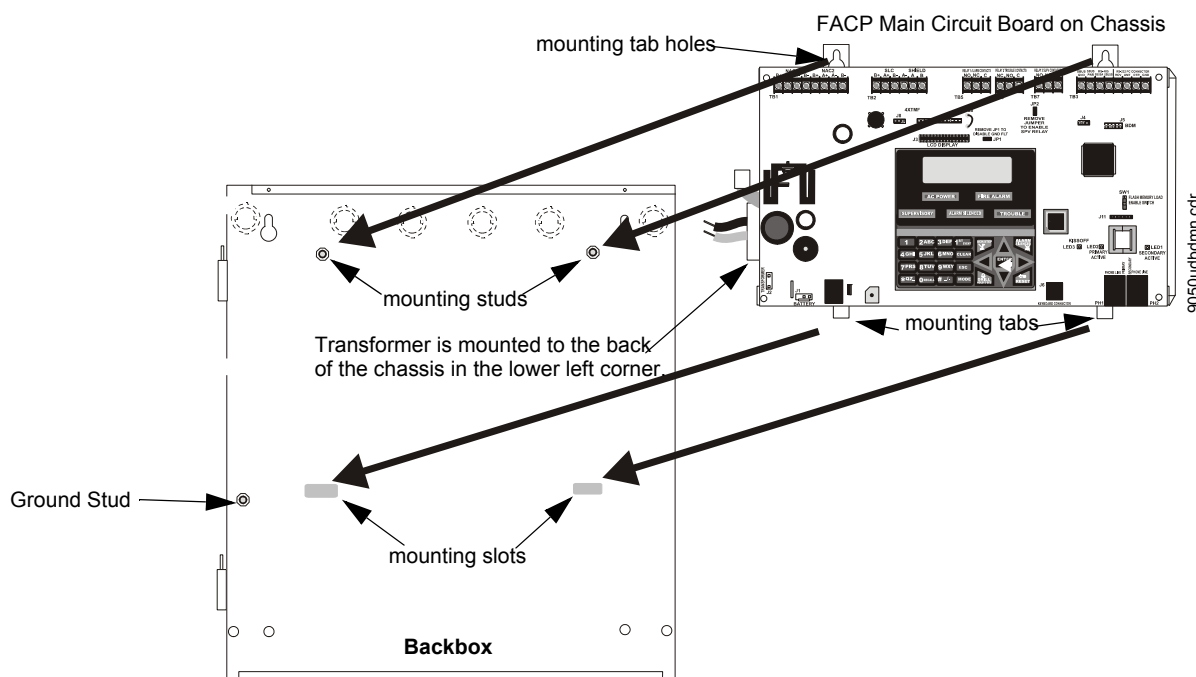

Figure 2.2 Main Circuit Board/Chassis Installation

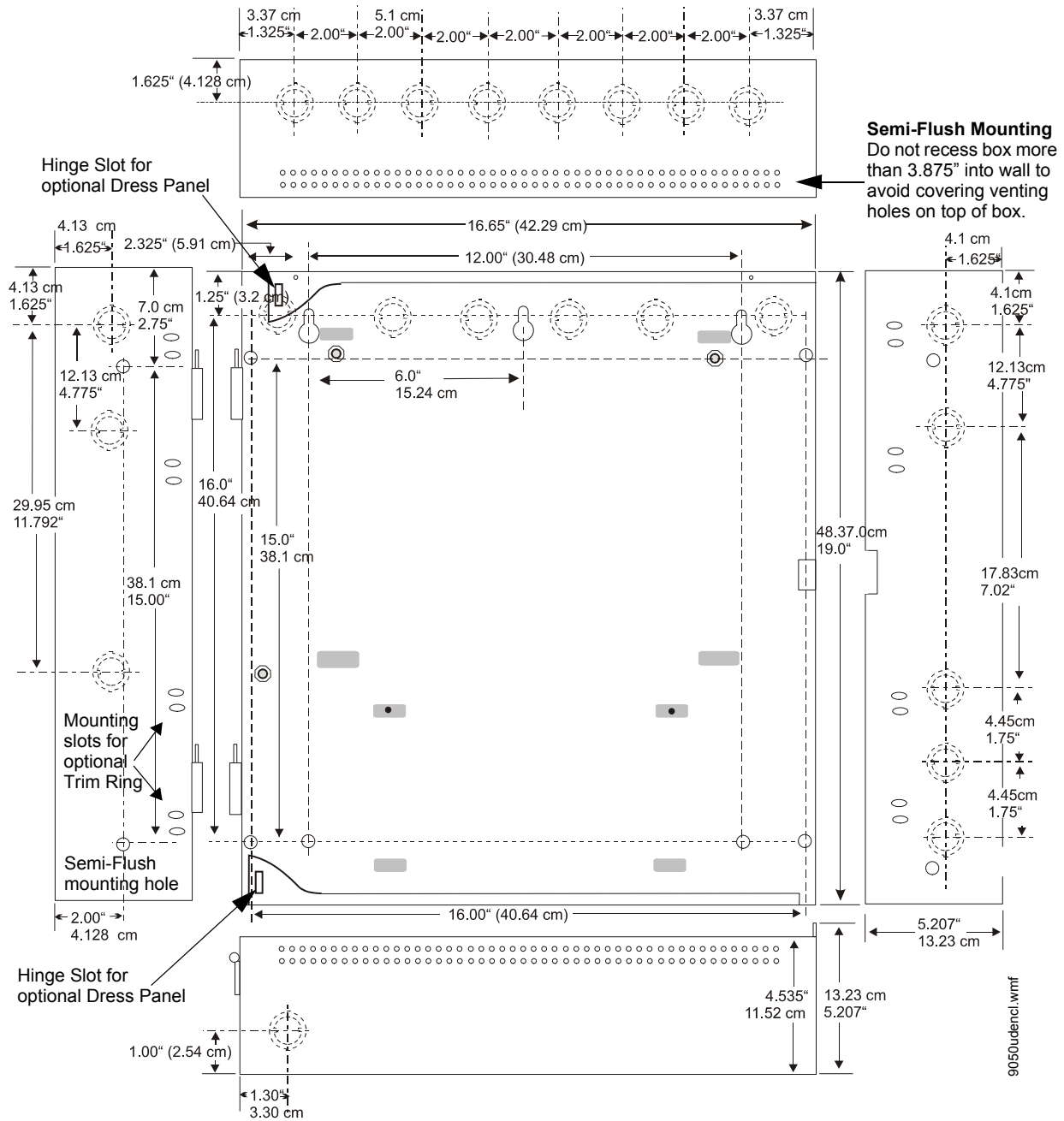
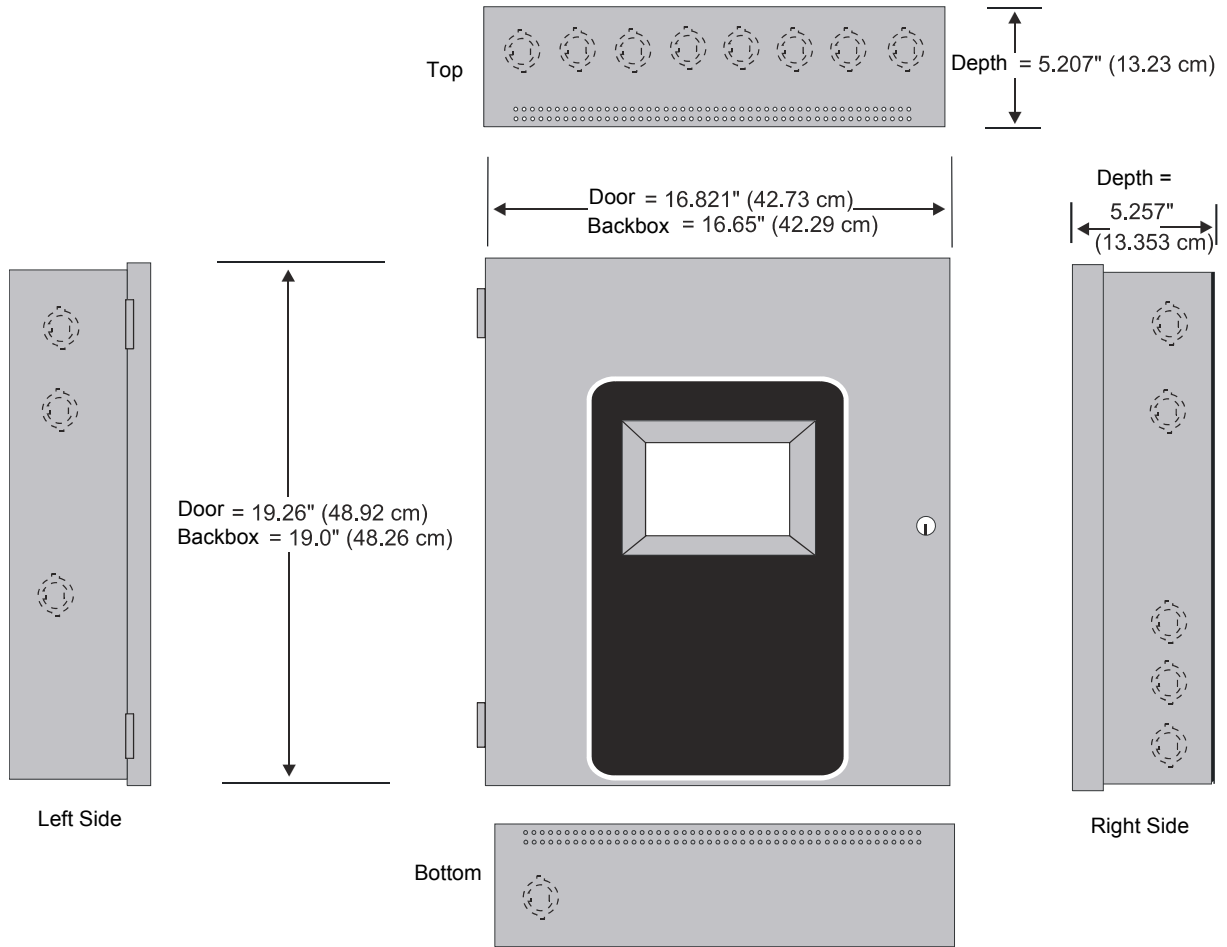

Figure 2.3 FACP Cabinet Mounting



9050udcab2.wmf

Figure 2.4 FACP Cabinet Dimensions

2.3 Power



WARNING: RISK OF DAMAGE AND ELECTRICAL SHOCK

SEVERAL DIFFERENT SOURCES OF POWER CAN BE CONNECTED TO THIS PANEL. DISCONNECT ALL SOURCES OF POWER BEFORE SERVICING. THE PANEL AND ASSOCIATED EQUIPMENT MAY BE DAMAGED BY REMOVING AND/OR INSERTING CARDS, MODULES OR INTERCONNECTING CABLES WHILE THIS UNIT IS ENERGIZED.

2.3.1 AC Power and Earth Ground Connection

Primary power required for the MS-9050UD/C FACP is 120 VAC, 60 Hz, 3.0 amps or 240 VAC, 50 Hz, 1.5 amps for the MS-9050UDE. Overcurrent protection for this circuit must comply with Article 760 of the National Electrical Code (NEC) and/or local codes. Use 14 AWG (2.00 mm²) or larger wire with 600 volt insulation rating. Make certain that the AC main circuit breaker is *off* before wiring any connections between the mains and the control panel. Connect wiring from the AC mains to the Transformer on the FACP, being careful to observe proper connections.

Connect the AC ground wire to the Ground Stud located in the left side of the backbox. Refer to Figure 2.2 on page 25 and the illustration below for location of the stud. This connection is vital for maintaining the control panel's immunity to unwanted transients generated by lightning and electrostatic discharge. Apply AC power to the panel only after the system is completely installed and visually checked. *Note that AC power must be applied to the panel before installing the battery interconnect cable (refer to the following section).*

For AC connections to the MS-9050UDC, refer to "AC Power Connections for Canadian Applications" on page 211.

2.3.2 Battery Power

Before connecting the batteries to the FACP, make certain that the interconnect cable between the batteries is *not* connected. Do not connect the interconnect cable until the system is completely installed. Observe polarity when connecting the batteries. Connect the battery cable to J1 on the main circuit board. Refer to "Power Supply Calculations" on page 180, for calculation of the correct battery rating.

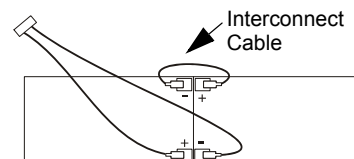

WARNING: BATTERIES CONTAIN SULFURIC ACID

BATTERIES CONTAIN SULFURIC ACID WHICH CAN CAUSE SEVERE BURNS TO THE SKIN AND EYES AND CAN DESTROY FABRICS. IF CONTACT IS MADE WITH SULFURIC ACID, IMMEDIATELY FLUSH THE SKIN OR EYES WITH WATER FOR 15 MINUTES AND SEEK IMMEDIATE MEDICAL ATTENTION.

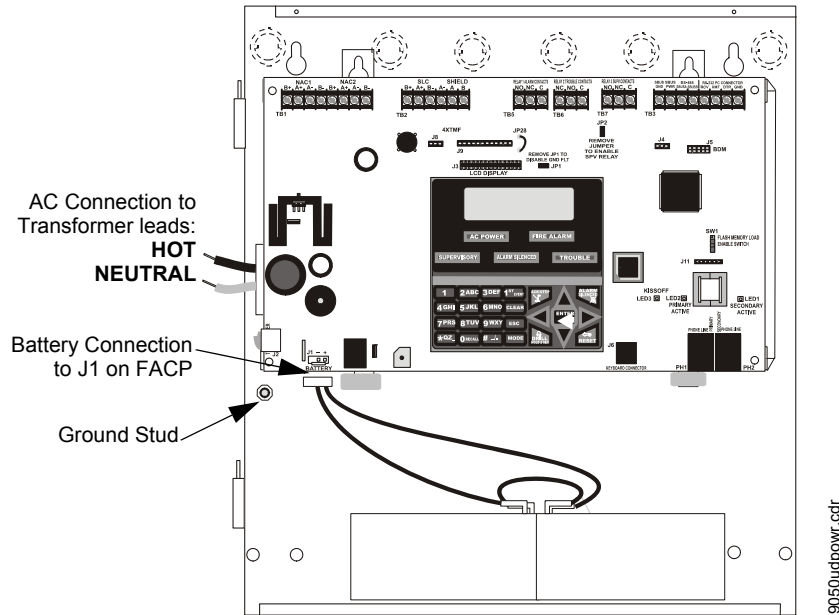

2.4 Relays

The FACP provides two programmable Form-C relays and one fixed fail-safe Form-C trouble relay, all with contacts rated for 2.0 amps @ 30 VDC (resistive) or 0.5 amps @ 30 VAC (resistive).

Note that relay connections must be nonpower-limited. Refer to UL Power-limited wiring requirements.

Note that the programmable relay labeled as Relay 1 is factory default programmed as Alarm and programmable Relay 3 is factory default programmed as Supervisory. The relay labeled Relay 2 is fixed as a Trouble relay and cannot be changed. It is a fail-safe relay which will transfer on any trouble or total power failure.

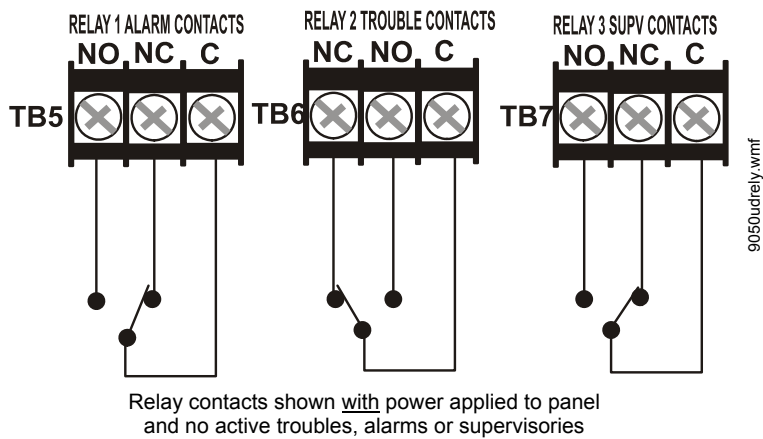

Figure 2.5 Relay Terminals

2.5 Notification Appliance Circuits

The control panel provides two NACs (Notification Appliance Circuits) Style Y (Class B) or Style Z (Class A). Each circuit is capable of 2.5 amps of current. Total current in alarm for all external devices cannot exceed 2.5 amps (refer to “Calculating the System Current Draw” on page 181). Use UL listed 24 VDC notification appliances only. Circuits are supervised and power-limited. Refer to the *Fire-Lite Device Compatibility Document* for a listing of compatible notification appliances. The NACs, which are located on the main circuit board, may be expanded via the Fire-Lite-FCPS Series field charger/power supplies.

NACs can also be configured for auxiliary power. If set for auxiliary power (door holder, resettable power, non-resettable power) do not connect notification appliances. Refer to Section 1.2, “Specifications” for power capability.

The following sections describe the configuration and wiring of Style Y and Style Z Notification Appliance Circuits on the FACP main circuit board.

2.5.1 Configuring NACs

The Notification Appliance Circuits are configured for Style Y (Class B) or Style Z (Class A) by properly wiring the NAC devices to TB1 on the main circuit board as illustrated below.

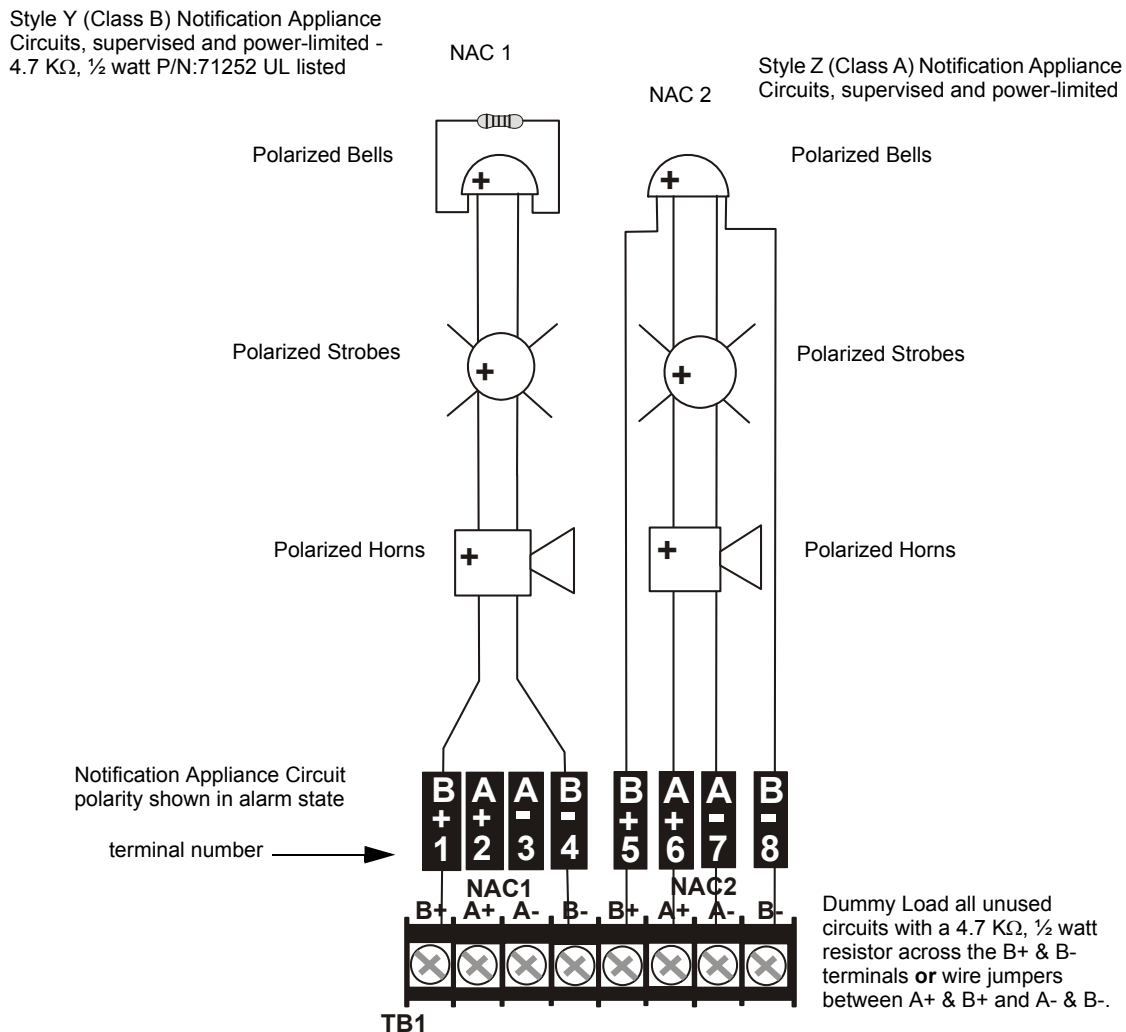

Figure 2.6 NAC Wiring

2.6 UL Power-limited Wiring Requirements

Power-limited and nonpower-limited circuit wiring must remain separated in the cabinet. All power-limited circuit wiring must remain at least 0.25" (6.35 mm) away from any nonpower-limited circuit wiring and nonpower-limited circuit wiring must enter and exit the cabinet through different knockouts and/or conduits. A typical wiring diagram for the FACP is shown below.

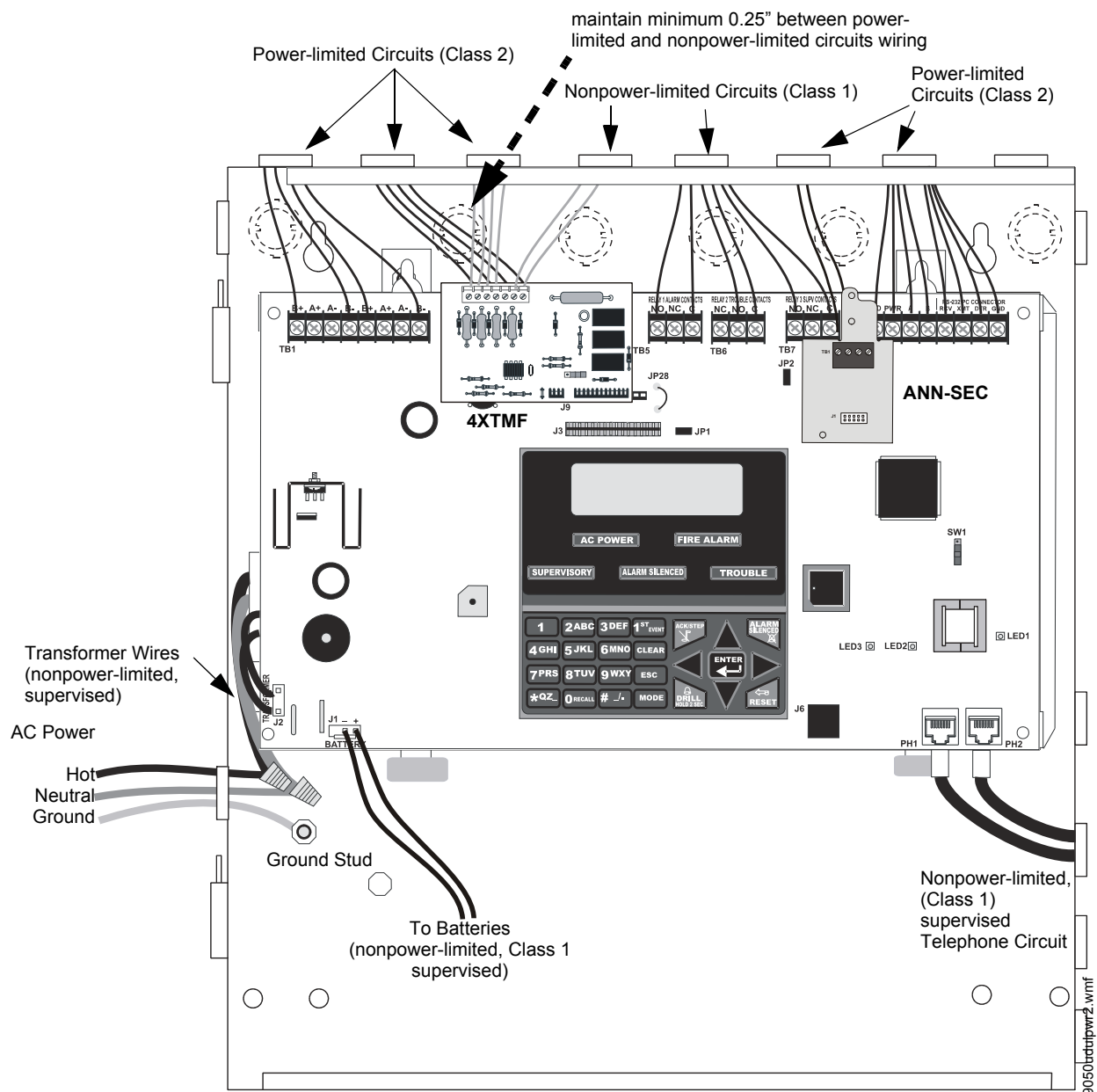

Figure 2.7 Typical UL Power-limited Wiring Requirements

2.7 Digital Communicator

Two independent telephone lines can be connected to the control panel. Telephone line control/command is made possible via double line seizure as well as usage of an RJ31X style interconnection. Note that it is critical that the panel's digital communicator be located as the first device on the incoming telephone circuit to properly function.

Important! The DACT must not be used to dial a phone number that is call-forwarded per requirements of UL 864 9th Edition.

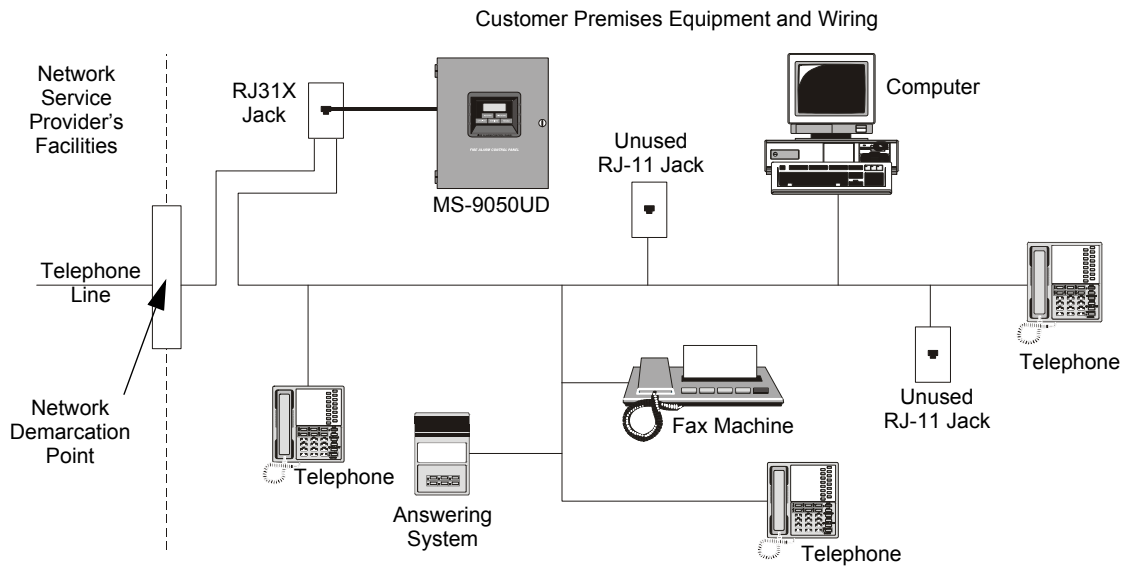

Figure 2.8 DACT Installation

9050ACTAdact.wmf

The control panel's digital communicator is built into the main circuit board. Connection and wiring of two phone lines is required as shown below.

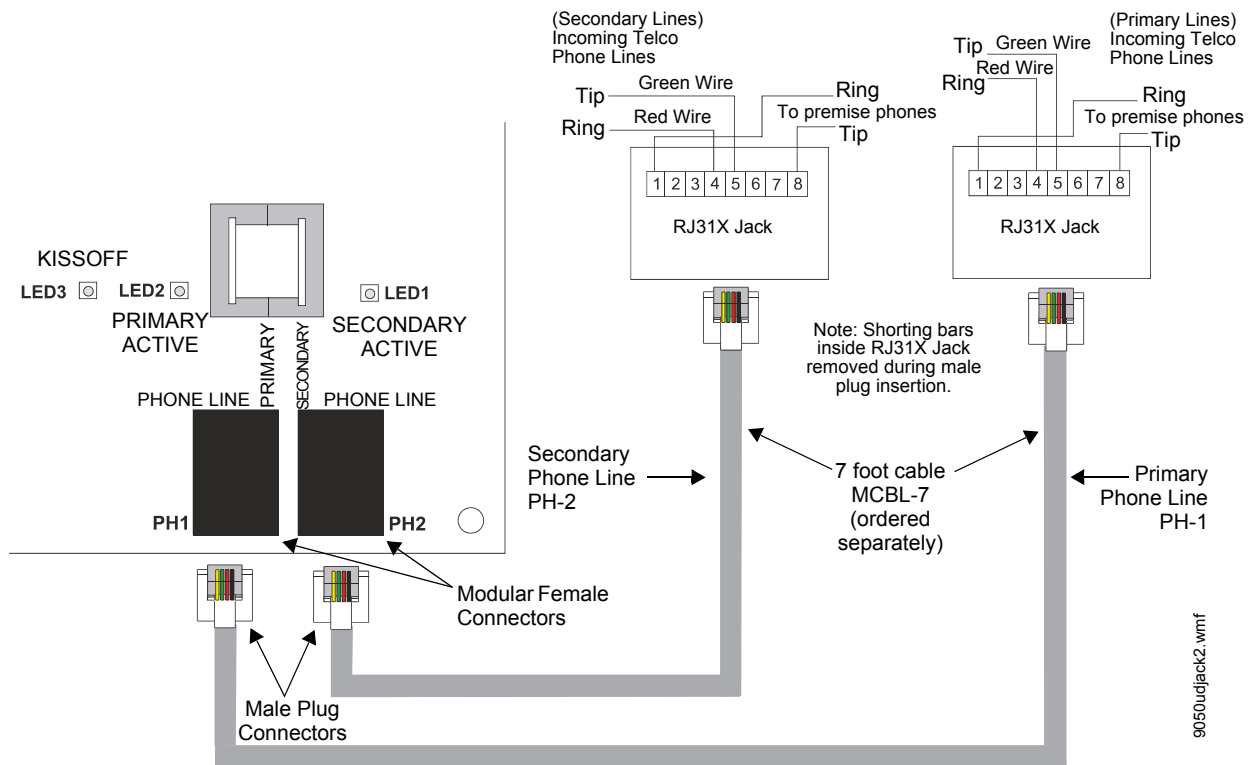

Figure 2.9 Wiring Phone Jacks

9050udjack2.wmf

2.8 Optional Modules/Accessories Installation



WARNING: RISK OF ELECTRIC SHOCK

DISCONNECT ALL SOURCES OF POWER (AC AND DC) BEFORE INSTALLING OR REMOVING ANY MODULES OR WIRING.

2.8.1 4XTMF Transmitter Module Installation

The 4XTMF provides a supervised output for a local energy municipal box transmitter in addition to alarm and trouble reverse polarity. A jumper option allows the reverse polarity circuit to open with a system trouble condition if no alarm condition exists. A disable switch allows disabling of the transmitter output during testing to prevent accidental calling of the monitoring service.

Local Energy Municipal Box Service (NFPA 72 Auxiliary Fire Alarm Systems):

Supervisory Current: 5.0 mA

Trip Current: 350 mA (subtracted from notification appliance power)

Coil Voltage: 3.65 VDC

Maximum Coil Resistance: 14.6 ohms

Maximum allowable wire resistance between panel and trip coil: 3 ohms

Municipal Box wiring can leave the building

Remote Station Service (NFPA 72 Remote Station Fire Alarm Systems) - Intended for connection to a polarity reversal circuit or a Remote Station receiving unit having compatible ratings:

Maximum load for each circuit: 10 mA

Reverse polarity output voltage: 24 VDC

Remote Alarm and Remote Trouble wiring can leave the building

Before installing the module, place the disconnect switch to the right (disconnect) position to prevent accidental activation of the municipal box. Note that a Disconnect LED will illuminate after the module is installed in the MS-9050UD. In addition, the System Trouble LED will turn on to indicate the Disconnect condition.

Note: 4XTMF Module is not directly suitable for transmitting reverse polarity supervisory signal. For an application using reverse polarity of a supervisory signal, refer to “FACP with Keltron” on page 198.

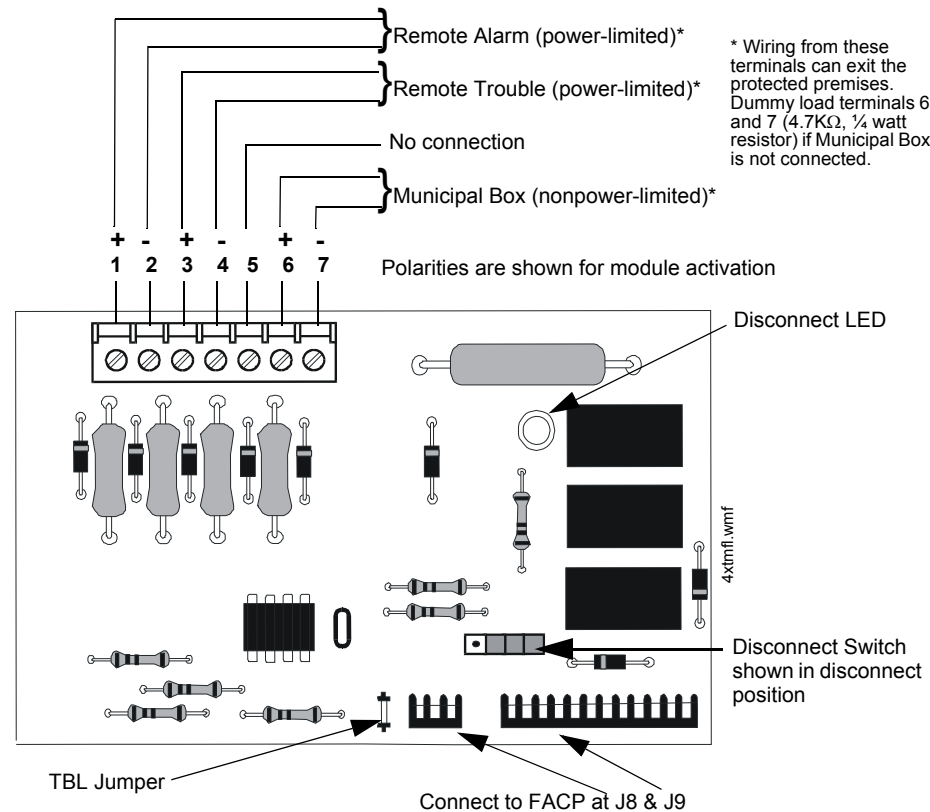

Figure 2.10 4XTMF Transmitter Module

The following steps must be followed when installing the 4XTMF module:

1. Remove all power (Primary and Secondary) from the FACP before installing 4XTMF.
2. Cut jumper JP28 on the main circuit board to allow the control panel to supervise the 4XTMF module.
3. Remove two screws securing main circuit board to mounting plate and install two standoffs for securing 4XTMF module to main circuit board. Refer to Figure 2.11 for standoff locations on main circuit board.
4. Carefully plug the connectors on the 4XTMF module into connectors J8 and J9 on the MS-9050UD main circuit board, being careful not to bend any pins.
5. Secure 4XTMF module to standoffs with supplied screws removed in step 3.
6. Reapply power to the FACP.
7. For proper 4XTMF operation, the main circuit board output relays must be programmed for the factory default settings: Alarm Relay 1, Trouble Relay 2, and Supervisory Relay 3.
8. When the installation has been completed, enable the 4XTMF module by sliding the disconnect switch to the left.

9. Test system for proper operation.

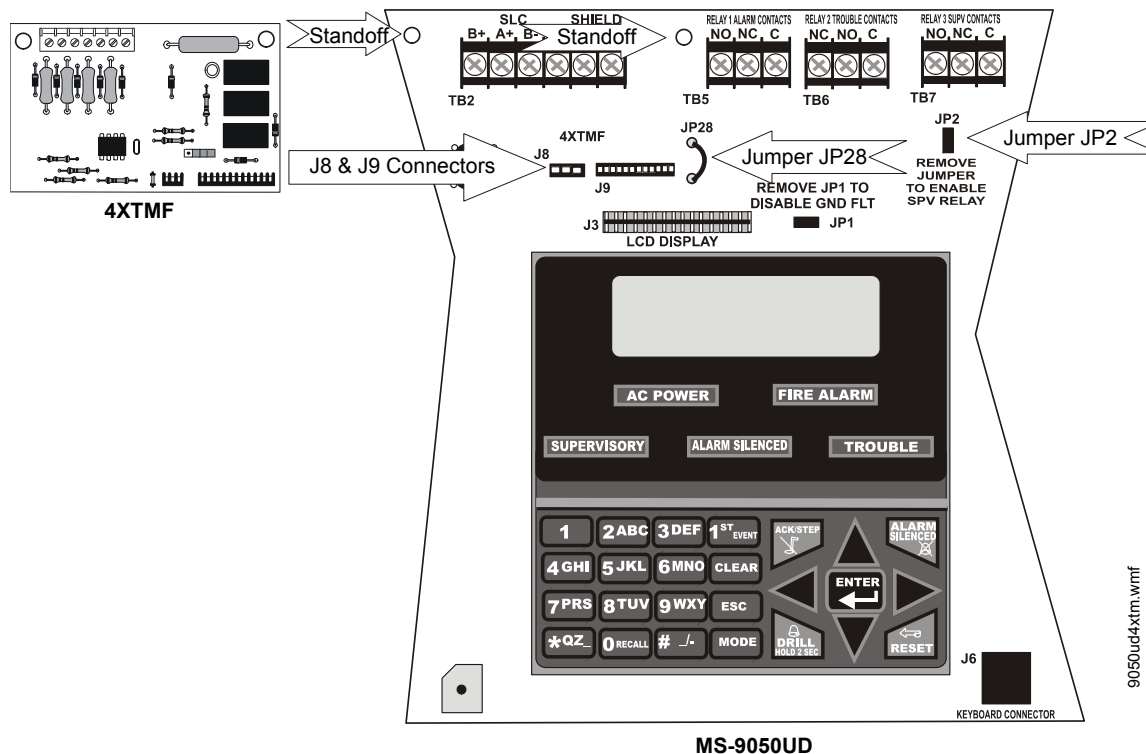

Figure 2.11 4XTMF Connectors to MS-9050UD Connectors



NOTE: Jumper JP2 on the FACP main circuit board can be used to configure the FACP supervisory relay for operation with the 4XTMF module. Relay 3 at TB3 must be programmed as a supervisory relay.
 Removing the jumper from JP2 will allow the 4XTMF to generate a trouble if the supervisory contact opens
 Leaving the jumper on JP2 will prevent generation of a trouble if the supervisory contact opens

2.8.2 ANN-SEC Option Card

The ANN-SEC option card allows for a secondary ANN-BUS. Install the ANN-SEC as follows.

1. Remove the chassis mounting screw to the right of TB7 and replace it with the supplied 0.5” x 4-40 male-female standoff.
2. Install the header into J13 on the main circuit board.

- Secure the ANN-SEC to the circuit board with the supplied screw.

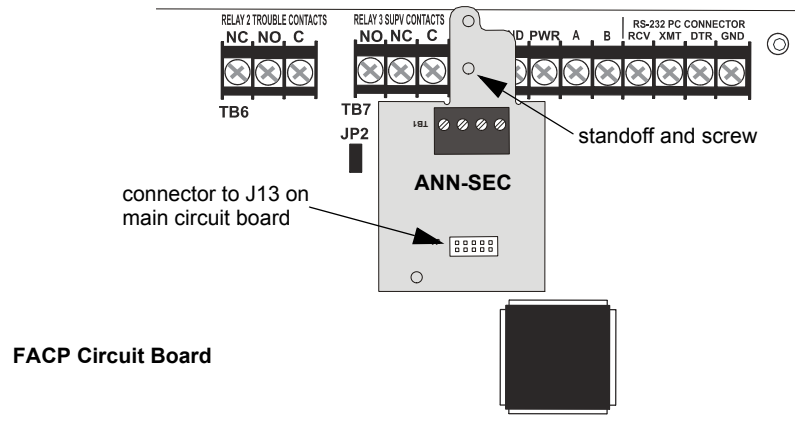

Figure 2.12 Installing the ANN-SEC Option Card

2.9 ANN-BUS Devices



WARNING: RISK OF ELECTRICAL SHOCK

DISCONNECT ALL SOURCES OF POWER (AC AND DC) BEFORE INSTALLING OR REMOVING ANY MODULES OR WIRING.

Guidelines

- A variety of optional annunciation devices can be connected to an ANN-BUS communication circuit. ANN Series devices can be connected to the primary communication circuit (EIA-485) terminals on TB3. A secondary communication circuit (EIA-485) for these devices is available at TB1 on the ANN-SEC card.
- When using one ANN-BUS circuit, up to eight (8) annunciators can be supported.
- When using both ANN-BUS communication circuits, the primary circuit supports up to three (3) annunciators and the secondary circuit supports up to (5) annunciators.
Compatible devices include:
 - ANN-80 LCD Annunciator
 - ANN-80C LCD Indicator (Canadian Applications)
 - ANN-S/PG Serial/Parallel Printer Interface Module
 - ANN-I/O LED Driver Module
 - ANN-LED Annunciator Module
 - ANN-RLED Annunciator Module (red alarm LEDs only)
 - ANN-RLY Relay Module
- When operating two ANN-BUS circuits, only one ANN-S/PG Printer module can be used in the system.
- The panel is capable of operating a primary ANN-BUS (TB3) and a secondary ANN-BUS (TB1 on ANN-SEC card) simultaneously.

2.9.1 ANN-BUS Wiring

This section contains information on calculating ANN-BUS wire distances and the types of wiring configurations (Class B).

Calculating Wiring Distance for ANN-BUS Modules

The following instructions will guide the installer in determining the type of wire and the maximum wiring distance that can be used with FACP ANN-BUS accessory modules.

To calculate the wire gauge that must be used to connect ANN-BUS modules to the FACP, it is necessary to calculate the total worst case current draw for all modules on a single 4-conductor bus. The total worst case current draw is calculated by adding the individual worst case currents for each module. The individual worst case values are shown in the following table:

Model Number	Worst Case Current Draw ¹
ANN-80(C) LCD Annunciator/Indicator	0.040 amps
ANN-S/PG Serial/Parallel Printer Interface Module	0.040 amps
ANN-I/O LED Driver Module	0.200 amps
ANN-RLY Relay Module	0.075 amps
ANN-(R)LED Annunciator Module	0.068 amps

- ¹ Total worst case current draw on a single ANN-BUS cannot exceed 0.5 amp. If current draw exceeds 0.5 amps, refer to "Powering ANN-BUS Devices from Auxiliary Power Supply" on page 39.

After calculating the total worst case current draw, Table 2.1 specifies the maximum distance the modules can be located from the FACP on a single wire run. The table ensures 6.0 volts of line drop maximum. In general, the wire length is limited by resistance, but for heavier wire gauges, capacitance is the limiting factor. These cases are marked in the chart with an asterisk (*). Maximum length can never be more than 6,000 feet (1,800 m), regardless of gauge used. The formula used to generate this chart is shown in the note below.

Wiring Distance: ANN-BUS Modules to FACP				
Total Worst Case Current Draw (amps)	22 Gauge	18 Gauge	16 Gauge	14 Gauge
0.100	1,852 ft.	4,688 ft.	* 6,000 ft.	*6,000 ft.
0.200	926 ft.	2,344 ft.	3,731 ft.	5,906 ft.
0.300	617 ft.	1,563 ft.	2,488 ft.	3,937 ft.
0.400	463 ft.	1,172 ft.	1,866 ft.	2,953 ft.
0.500	370 ft.	938 ft.	1,493 ft.	2,362 ft.

Table 2.1 Wiring Distances

The following formulas were used to generate the wire distance chart:

$$\text{Maximum Resistance (Ohms)} = \frac{6.0 \text{ Volts}}{\text{Total Worst Case Current Draw (amps)}}$$

$$\text{Maximum Wire Length (feet)} = \frac{\text{Maximum Resistance (Ohms)}}{\text{Rpu}} \times 500$$

(6,000 feet maximum)

where: Rpu = Ohms per 1,000 feet for various Wire Gauges (see table below)

Wire Gauge	Ohms per 1,000 feet (Rpu)
22	16.2

18	6.4
16	4.02
14	2.54

Exception: When using the ANN-RLY module, the installer must ensure that the maximum 24VDC power line drop does not exceed 0.3 volts. This results in the following wiring limitations:

Wire Gauge	Maximum Wire Length
18	312 feet
16	497 feet
14	787 feet
12	1,250 feet

Wiring Distance Calculation Example:

Suppose a system is configured with the following ANN-BUS modules:

- 3 ANN-80 Remote Fire Annunciators
- 1 ANN-S/PG Serial/Parallel Printer Interface Module
- 1 ANN-I/O LED Driver Module

The total worst case current is calculated as follows:

ANN-80 Current Draw	= 3 X 0.040 amps	= 0.120 amps
ANN-S/PG Current Draw	= 1 X 0.040 amps	= 0.040 amps
ANN-I/O Current Draw	= 1 X 0.200 amps	= 0.200 amps
Total Worst Case Current Draw		= 0.360 amps

Using this value and referring to the Wiring Distance Table 2.1 on page 37, it can be found that the available options are:

- ✓ 463 feet maximum using 22 Gauge wire
- ✓ 1,172 feet maximum using 18 Gauge wire
- ✓ 1,866 feet maximum using 16 Gauge wire
- ✓ 2,953 feet maximum using 14 Gauge wire

Wiring Configuration

Figure 2.13 illustrates the wiring between the FACP and ANN-BUS devices.

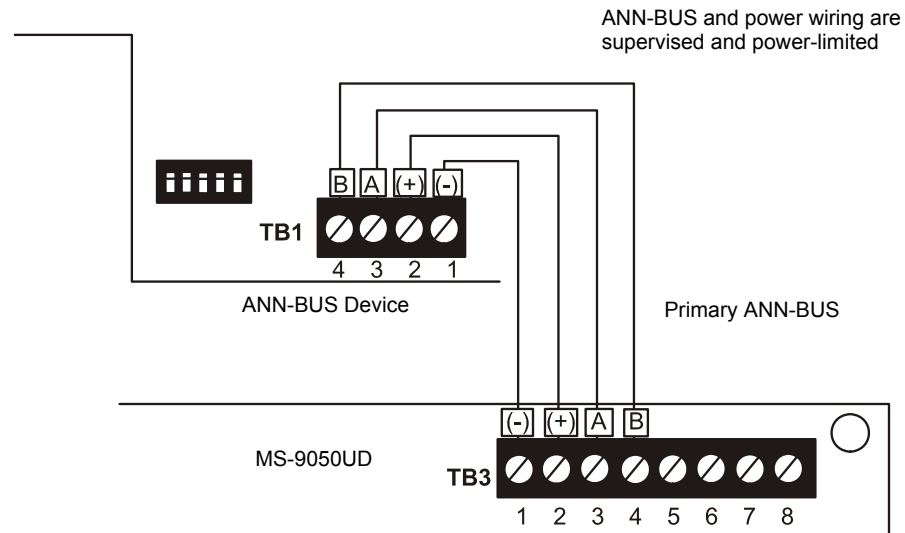

Figure 2.13 FACP wiring to ANN-BUS Device

Powering ANN-BUS Devices from Auxiliary Power Supply

Figure 2.14 illustrates the powering of ANN-BUS devices from an auxiliary power supply such as the FCPS-24FS6/8, when the maximum number of ANN-BUS devices exceeds the ANN-BUS power requirements.

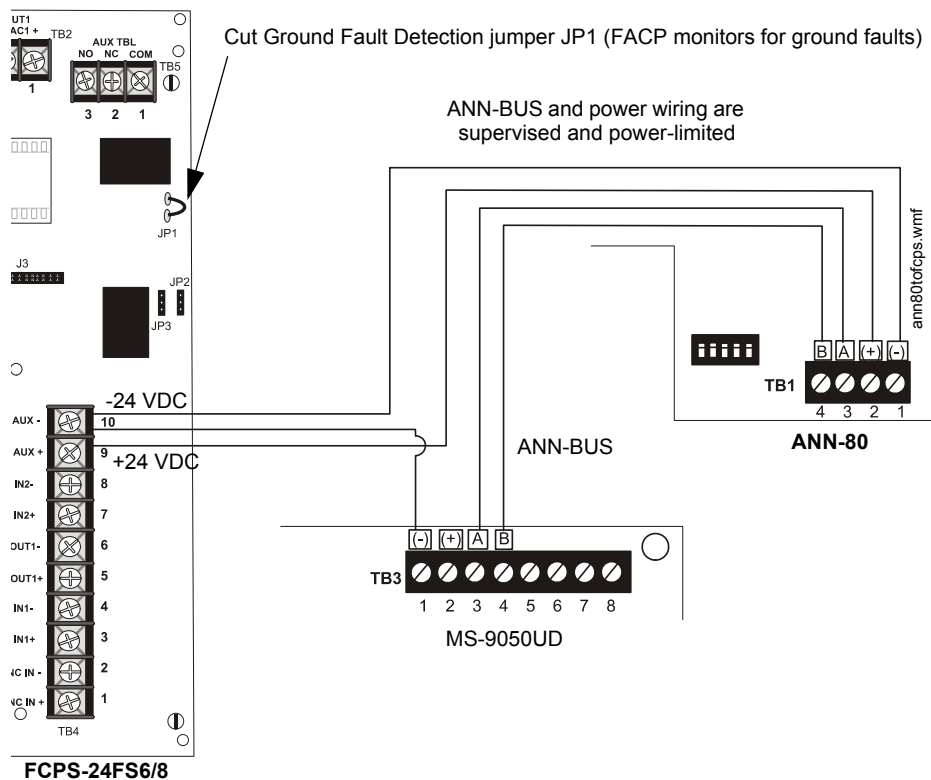

Figure 2.14 Powering ANN-BUS Devices from FCPS-24FS6/8

2.9.2 ANN-BUS Device Addressing

Each ANN-BUS device requires a unique address (ID Number) in order to communicate with the FACP. A 5-position DIP switch on each device is used to set this address. The address set for these devices must also be programmed at the FACP for the specific device (refer to the programming section titled “ANN-BUS” on page 108).

A maximum of 8 devices can be connected to the FACP ANN-BUS communication circuit. Device addresses do not need to be sequential and can be set to any number between 01 and 08. Note that 00 is not a valid address. The following table shows the DIP switch setting for each address.

Address	Switch 5 ¹	Switch 4	Switch 3	Switch 2	Switch 1
not valid	OFF	OFF	OFF	OFF	OFF
01	OFF	OFF	OFF	OFF	ON
02	OFF	OFF	OFF	ON	OFF
03	OFF	OFF	OFF	ON	ON
04	OFF	OFF	ON	OFF	OFF
05	OFF	OFF	ON	OFF	ON
06	OFF	OFF	ON	ON	OFF
07	OFF	OFF	ON	ON	ON
08	OFF	ON	OFF	OFF	OFF

1 Switch 5 must be set to OFF for ANN-BUS devices to be recognized.

2.9.3 ANN-80(C) Remote Fire Annunciator/Indicator

The ANN-80(C) Annunciator/Indicator is a compact, 80 character, backlit LCD remote fire annunciator which mimics the FACP display. It also provides system status indicators for AC Power, Alarm, Trouble, Supervisory and Alarm Silenced conditions. The ANN-80 Annunciator provides a button for Reset, Silence, Acknowledge, and Drill. The ANN-80C does not provide these buttons. Communication between the ANN-80(C) and FACP is accomplished over a two wire serial interface employing the ANN-BUS communication format. The devices are powered, via two additional wires, from either the host FACP or remote UL-listed, filtered, power supply.

Specifications

- Operating Voltage Range: 18 VDC to 28 VDC
- Current Consumption @ 24 VDC nominal (filtered and nonresettable):
 - ✓ Normal/Standby (no activity): 37.0 mA
 - ✓ Trouble: 39.0 mA
 - ✓ Alarm: 40.0 mA
 - ✓ AC Fail (not backlit): 15.0 mA
- For use indoors in a dry location

Installation

Ensure that all power (AC and DC) has been removed from the FACP before installing the annunciator.

Opening/Closing Annunciator

The following procedure details the steps used to open the annunciator in order to access the terminal block and DIP switches (refer to figure below):

1. Turn the key switch to the ON (Unlocked) position by turning the key counter-clockwise
2. Push in the snap latch located on the right side of the unit while pulling the cover open

3. To close the cover, make certain the key switch is in the ON (Unlocked) position. Swing the cover closed, snapping it shut
4. Turn the key switch to the OFF (Locked) position by turning clockwise and remove the key

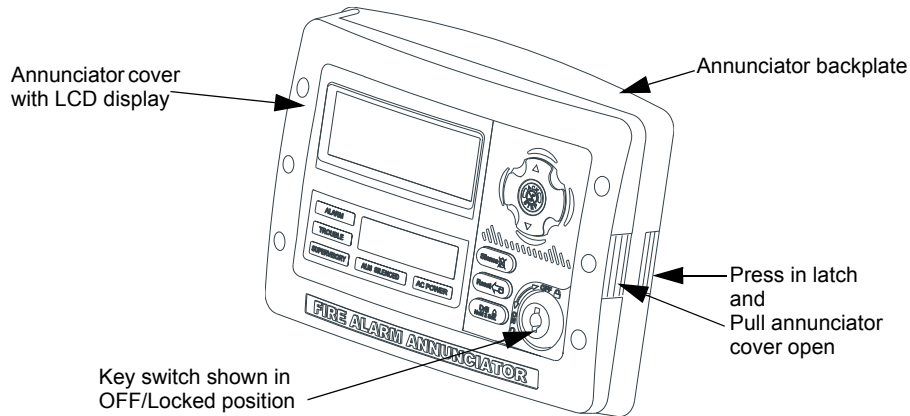

ann-80_iso.wmf

Mounting

The ANN-80 can be surface or semi-flush mounted to a single, double or 4" square electrical box. Select and remove the appropriate knockout(s), pull the necessary wires through the knockouts and mount the annunciator in or on the wall depending on the type of installation desired.

The ANN-SB80KIT(-R/-W) is an available mounting kit for the ANN-80 annunciator. The kit comes with a surface backbox and surface wedge for angled viewing. The two pieces can be used separately or can be stacked together.

The ANN-80 cover must be attached to the annunciator backplate before mounting the annunciator to the electrical box/wall. The cover cannot be reattached or removed after the annunciator has been mounted.

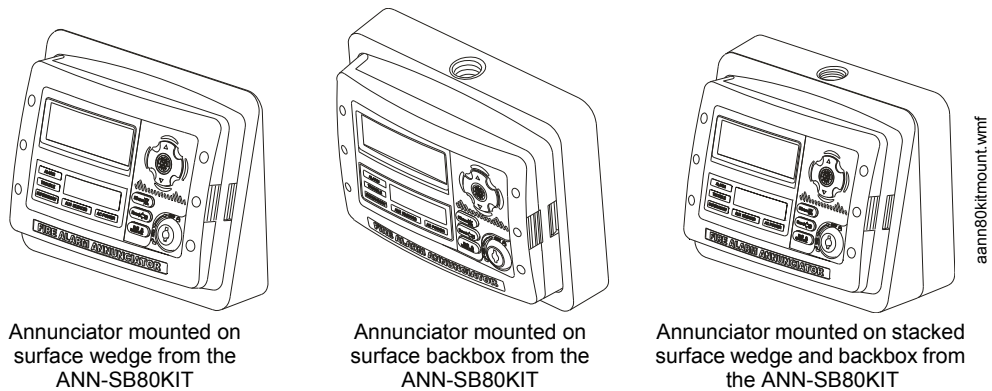

ann80kitmount.wmf

Wiring ANN-80 to FACP

The following steps can be used as a guide to wire the annunciator. Make certain all power has been removed from the FACP prior to annunciator installation.

1. Route wires from hole in backplate, through wiring channel and then to ANN-80 terminal block TB1.

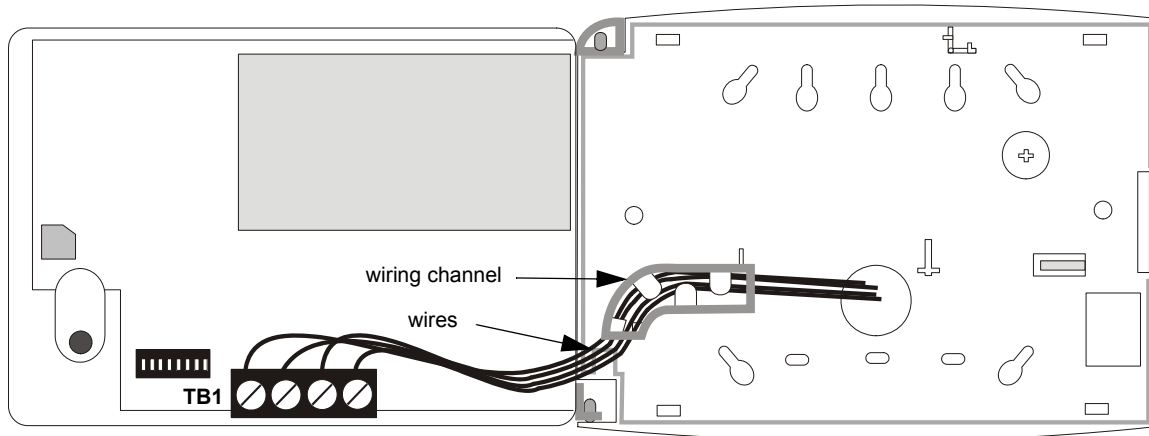

2. Remove appropriate amount of wire insulation.
3. Connect the wiring from the FACP ANN-BUS to annunciator TB1 terminals 3 (A) & 4 (B). Make certain to connect A to A and B to B.
4. If appropriate, connect the wiring going to the next device on the ANN-BUS to TB1 terminals 3 & 4. Make certain to connect A to A and B to B.
5. Connect the wiring from the 24 VDC power source to annunciator TB1 terminals 1 (-) & 2 (+). Make certain to observe proper polarity.
6. If appropriate, connect the power wiring going to the next device to terminals 1 (-) & 2 (+). Make certain to observe proper polarity.
7. After all connections are made, remove extra wire from inside of annunciator by dressing it neatly through wire channel, with any excess wire pushed back through hole into electrical box.

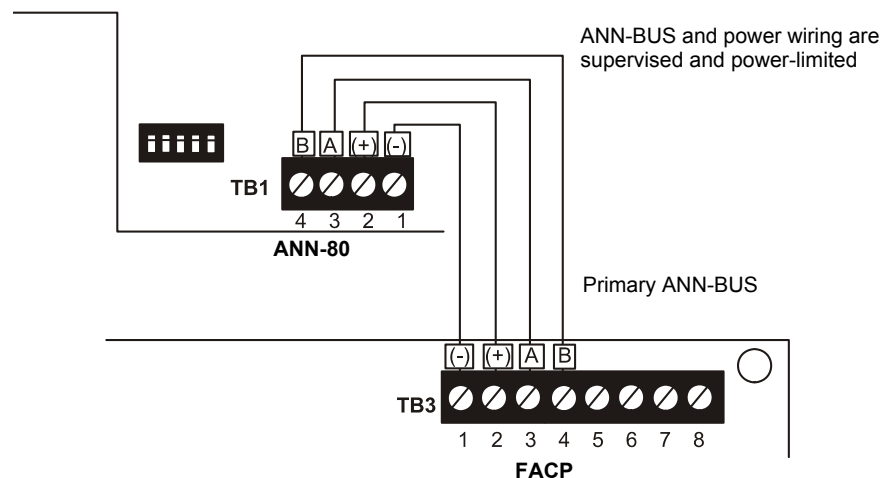

Figure 2.15 ANN-80 Wiring to FACP

The following table shows the ANN-80 connections to the MS-9050UD.

MS-9050UD (TB3)	ANN-80 (TB1)
Terminal 1 GND (-)	Terminal 1 (-)
Terminal 2 PWR (+)	Terminal 2 (+)
Terminal 3 A (ANN-BUS)	Terminal 3 (A)
Terminal 4 B (ANN-BUS)	Terminal 4 (B)

Programming

Following installation and wiring of the ANN-80 LCD annunciator to the FACP, the annunciator must be added to the system via FACP programming. Refer to the programming section titled “ANN-BUS” on page 108 in this manual for detailed programming information. Select the LCD option for programming.

Trouble Response

If the ANN-80 is installed but the ANN-BUS is not enabled at the FACP, the ANN-80 will indicate a trouble condition by NOT turning on its AC Power indicator. The LCD will also display *Key Bus Trouble* and the piezo will sound approximately once every 10 seconds. Note that the FACP will provide no indication of an ANN-80 trouble.

To clear the ANN-80 trouble condition, enable the ANN-BUS and program the address corresponding to the address set on the ANN-80 at the FACP.

2.9.4 ANN-S/PG Serial/Parallel Interface Module

The ANN-S/PG Serial/Parallel Interface module allows the connection of a serial or parallel printer to the FACP for a real-time log of system events, detector status reports and event history. The module is provided with a plastic enclosure for surface mounting. Proceed with the installation as described in the following:

1. Ensure that all power (AC and DC) has been removed from the FACP.
2. Connect the ANN-S/PG to the FACP as illustrated in Figure 2.16.

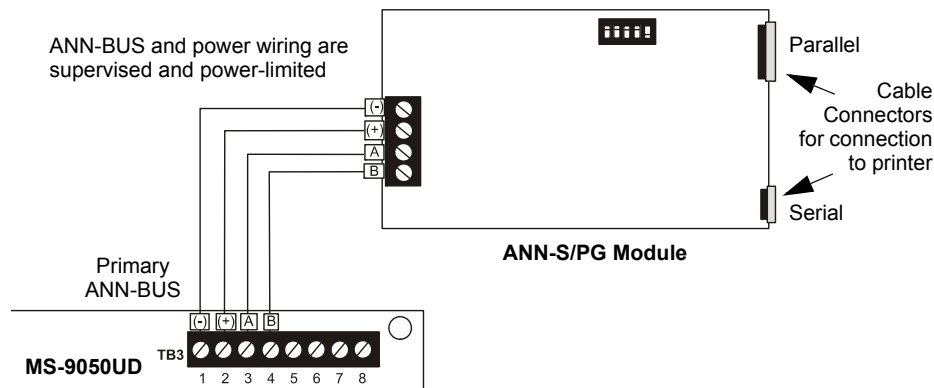

Figure 2.16 ANN-S/PG Connection to FACP

3. Using the DIP switches on the back of the ANN-S/PG module, assign an ID number (address) to the module.
4. Select the address and configuration options for the ANN-S/PG module as described in the Programming section of this manual (refer to “ANN-BUS” on page 108). Note that the Auto-configure feature allows the programmer to quickly bring all installed ANN-BUS modules online (refer to “Auto-Configure” on page 117).
5. Connect a printer to the ANN-S/PG Parallel or Serial connectors (refer to Figure 2.16). Only one printer can be connected.

Specifications

- Operating Voltage: 24 VDC
- Current (Alarm and Standby): 45 mA
- Ambient Temperature: 32°F to 120°F (0°C to 49°C)
- Max. Wiring Distance from FACP: 6,000 ft. (1,800 m)
- Mounting: Surface
- Dimensions: 6"W x 7-3/4"H x 1-7/16"D (15.2 cm W x 19.7 cm H x 3.7 cm D)
- For indoor use in a dry location only

PRN-6F Printer Installation

When connected to the FACP via the ANN-S/PG module, the PRN prints the status changes within the control panel and time-stamps the printout with the time of day and date that the event occurred. It provides 80 columns of data on standard 9" x 11" tractor-feed paper. This section contains information on connecting a printer to the control panel and setting the printer options.

■ Connecting PRN-6F Printer

Remote printers require a primary AC power source. If required for the fire alarm system configuration (for example, a Proprietary Fire Alarm System), a remote printer requires a secondary power source (battery backup). Since a secondary power source is not provided as a standard feature, a separate UL-listed Uninterruptible Power Supply (UPS) should be used. The building emergency power supply may be used, as long as it meets the power continuity requirements of NFPA 72. Refer to NFPA 72 for further details.

Connect the remote printer to the FACP via the ANN-S/PG module using a standard DB-25 cable. One end of the cable will plug into the DB-25 connector on the PRN printer and the other end plugs into the parallel connector on the ANN-S/PG module. Note that the 9-pin DB-9 port on the ANN-S/PG is used to connect a serial printer. The 25-pin port is used for a Centronics parallel printer cable. Connect either a serial or parallel printer, but not both at the same time.

■ Setting Printer Options

Refer to the documentation supplied with the PRN-6F printer for instructions on using the printer menu controls. Set the printer options (under the menu area) as shown in the following table:

Option	Setting	Option	Setting
Font	HS Draft	CPI	10CPI
LPI	6 LPI	Skip	0.5
ESC Character	ESC	Emulate	Epson FX-850
Bidirectional Copy	ON	I/O	
CG-TAB	Graphic	Buffer	40K
Country	E-US ASCII	Serial	
Auto CR	OFF	Baud	9600 or 2400
Color Option	Not Installed	Format	7 Bit, Even, 1 Stop
Formien		Protocol	XON/XOFF
Lines	6LPI=60	Character Set	Standard
Standard	Exec 10.5	Sl.Zero	On
		Auto LF	On
		PAPER	
		BIN 1	12/72"
		BIN 2	12/72"
		SINGLE	12/72"
		PUSH TRA	12/72"
		PULL TRA	12/72"
		PAP ROLL	12/72"

Table 2.2 PRN Setup Options

2.9.5 ANN-I/O LED Driver Module

The ANN-I/O is an LED driver module that can be used in a wide variety of applications, including as an interface with most customized graphic annunciators. The ANN-I/O can drive up to 40 LEDs. The module is provided with a plastic enclosure for mounting inside the annunciator or accessory box. The following sections describe hardware installation. Refer to the section titled “ANN-BUS” on page 108 for programming information.

ANN-I/O Board Layout

Figure 2.17 illustrates the ANN-I/O board showing locations of screw terminals for connection to the FACP, pin connectors for connecting LEDs and the DIP switch for selecting the ANN-BUS ID number.

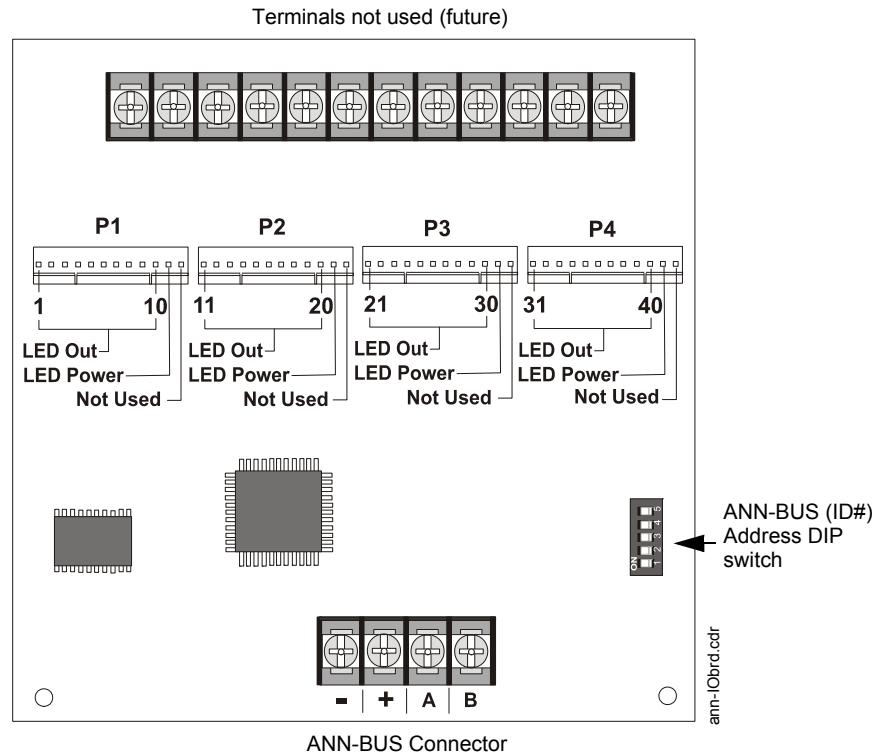

Figure 2.17 ANN-I/O Board Layout

Specifications

- Max. ANN-BUS Voltage: 28 VDC
- Max. Current:
 - ✓ Alarm: 200 mA
 - ✓ Standby: 35 mA
 - ✓ Each LED: 10 mA
- Operating Temperature: 32°F to 120°F (0°C to 49°C)
- For indoor use in a dry location only

ANN-I/O Connection to FACP

The ANN-I/O connects to the FACP via the ANN-BUS as illustrated in Figure 2.18. After the ANN-I/O is connected to the panel, it must be added to the system via FACP programming. Refer to the section titled “Modules Installed” on page 109.

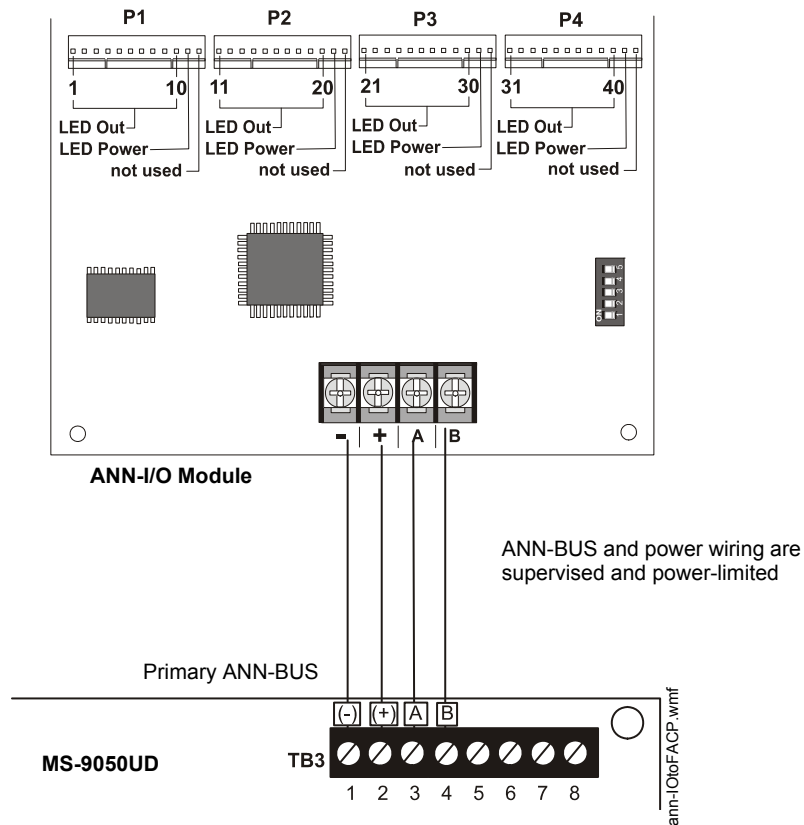

Figure 2.18 ANN-I/O Connection to FACP

ANN-I/O Module LED Wiring

There are four 12-pin connectors on the ANN-I/O module for connecting LEDs. Each set of 10 LEDs get their power from Pin 11 of the corresponding connector. Internal resistors are sized so that there is approximately 10 mA of current for each LED. No series resistors are required. LED outputs can be mapped to output circuits. Refer to the programming section titled “Modules Installed” on page 109 of this manual.

The LEDs are wired as illustrated in Figure 2.19. Note that the illustration depicts only connectors P1 and P2. Wiring is identical for P3 (LEDs 21-30) and P4 (LEDs 31-40).

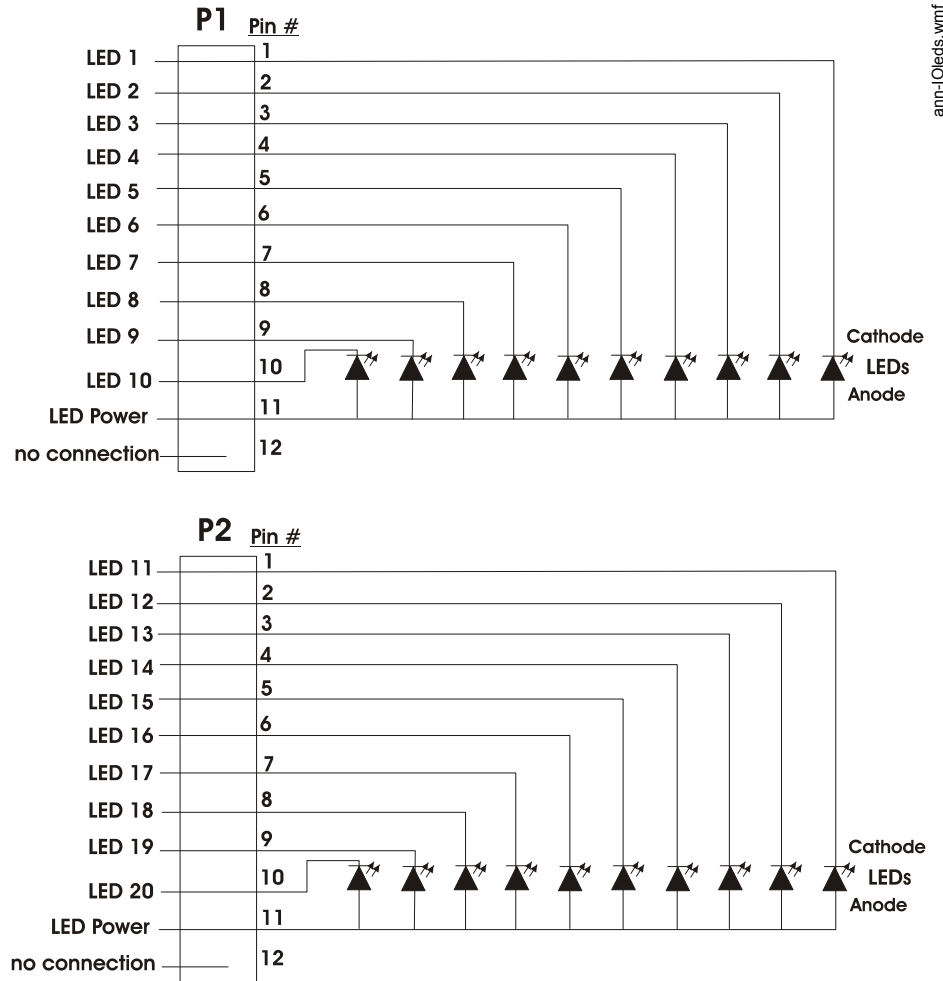
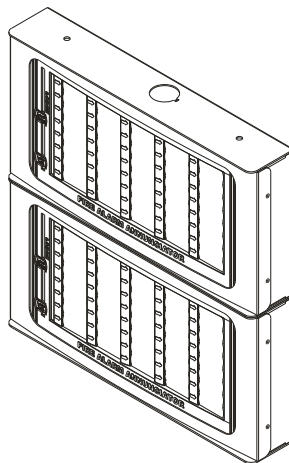

Figure 2.19 ANN-I/O LED Wiring

2.9.6 ANN-LED Annunciator Module

The ANN-LED and ANN-RLED annunciator modules provide LED annunciation of general system faults and input zones/points when used with a compatible FACP. The ANN-LED module provides alarm (red), trouble (yellow) and supervisory (yellow) indication for up to ten input zones or addressable points. The ANN-RLED provides alarm (red) indication for up to 30 input zones or addressable points. Multiple ANN-(R)LED modules may be used for full system coverage.



ann-ledstacked.wmf

Figure 2.20 ANN-LEDs (shown in possible stacked configuration)

Specifications

- Max. ANN-BUS Voltage: 24 VDC
- Max. Current:
 - ✓ Alarm: 68 mA
 - ✓ Standby: 28 mA
- Operating Temperature: 32° F to 120° F (0° C to 49° C)
- For indoor use in a dry location only

Mounting and Installation

The ANN-LED Module is supplied with a metal backbox, mounting bracket, and cover. Refer to the *ANN-LED Installation Document #53032* for more information.

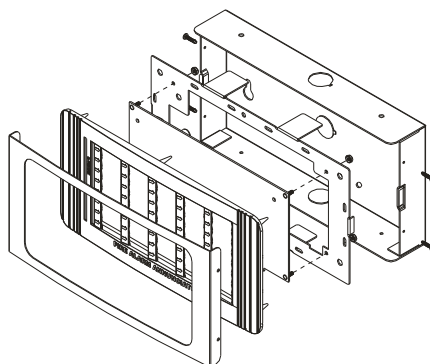

ann-led.wmf

Figure 2.21 Exploded View of ANN-LED

ANN-LED Board Layout and Connection to FACP

Figure 2.22 illustrates the ANN-LED board showing locations of screw terminals for connection to the FACP and the DIP switches for selecting the ANN-BUS ID number.

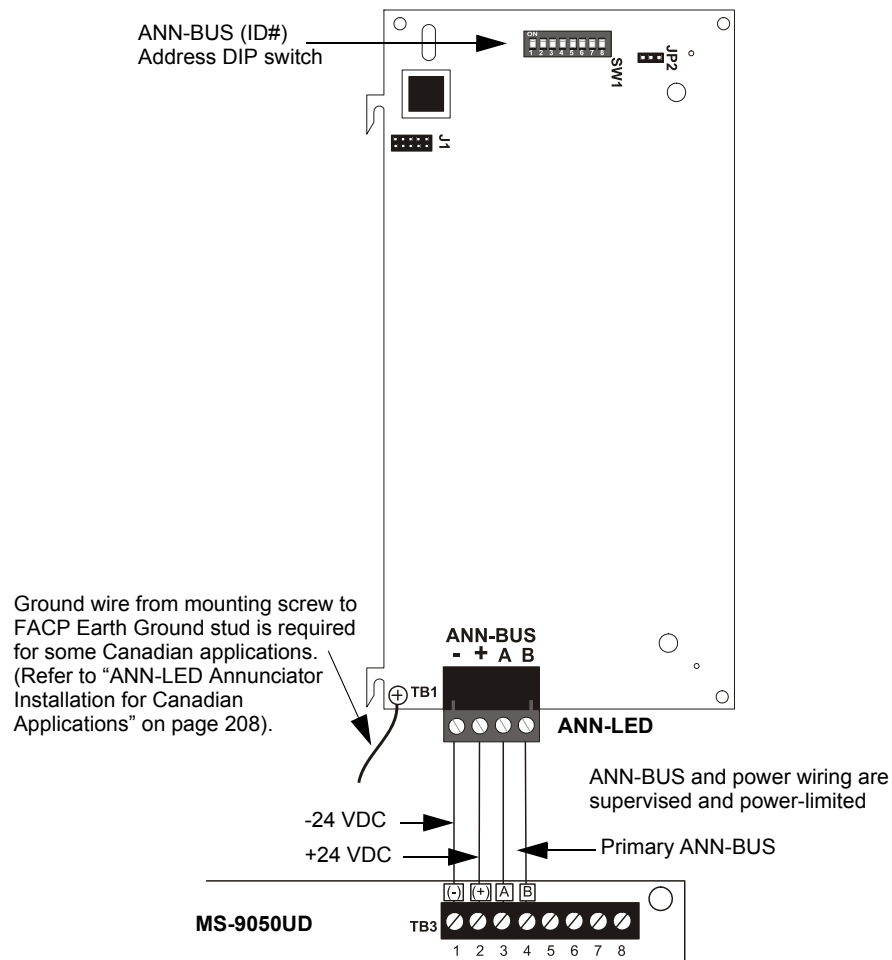

Figure 2.22 ANN-LED Connection to FACP

2.9.7 ANN-RLY Relay Module

The ANN-RLY relay module provides 10 programmable Form-C relays when used with a compatible FACP.

Specifications

- Operating Voltage: 24 VDC
- Max. Current:
 - ✓ Alarm: 75 mA
 - ✓ Standby: 15 mA
- Operating Temperature: 32° F to 120° F (0° C to 49° C)
- For indoor use in a dry location only

Mounting and Installation

The ANN-RLY relay module can be mounted inside the FACP main circuit board chassis or inside the ROME Series enclosure. Refer to the *ANN-RLY Installation Document #53033* for instructions on chassis mounting or to the *ROME Series Installation Document #53530* for mounting in the separate backbox.

FACP Chassis Installation

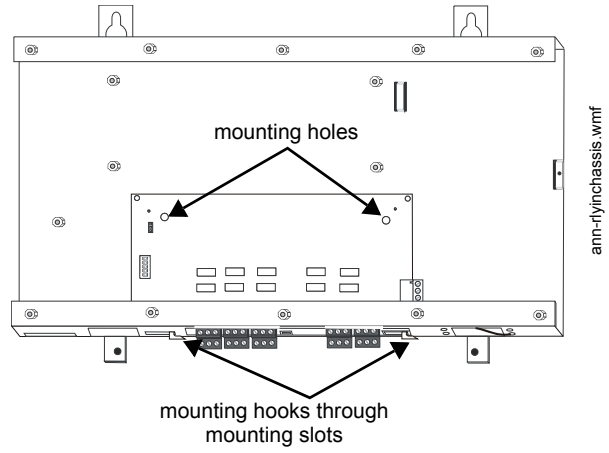

FACP Backbox Installation using ANN-MBRLY mounting bracket

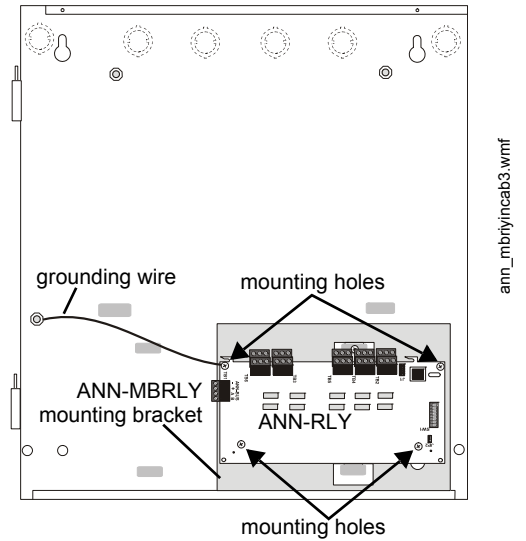

ROME Series Installation using ANN-MBRLY mounting bracket

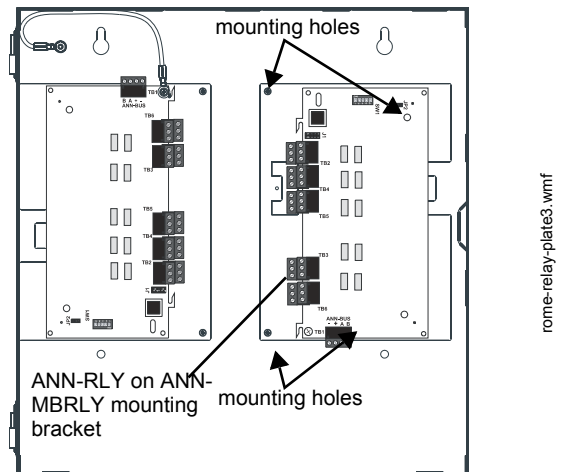

Figure 2.23 ANN-RLY Mounting Options

ANN-RLY Board Layout and Connection to FACP

Figure 2.24 illustrates the ANN-RLY board showing locations of screw terminals for connection to the FACP and the DIP switches for selecting the ANN-BUS ID number.

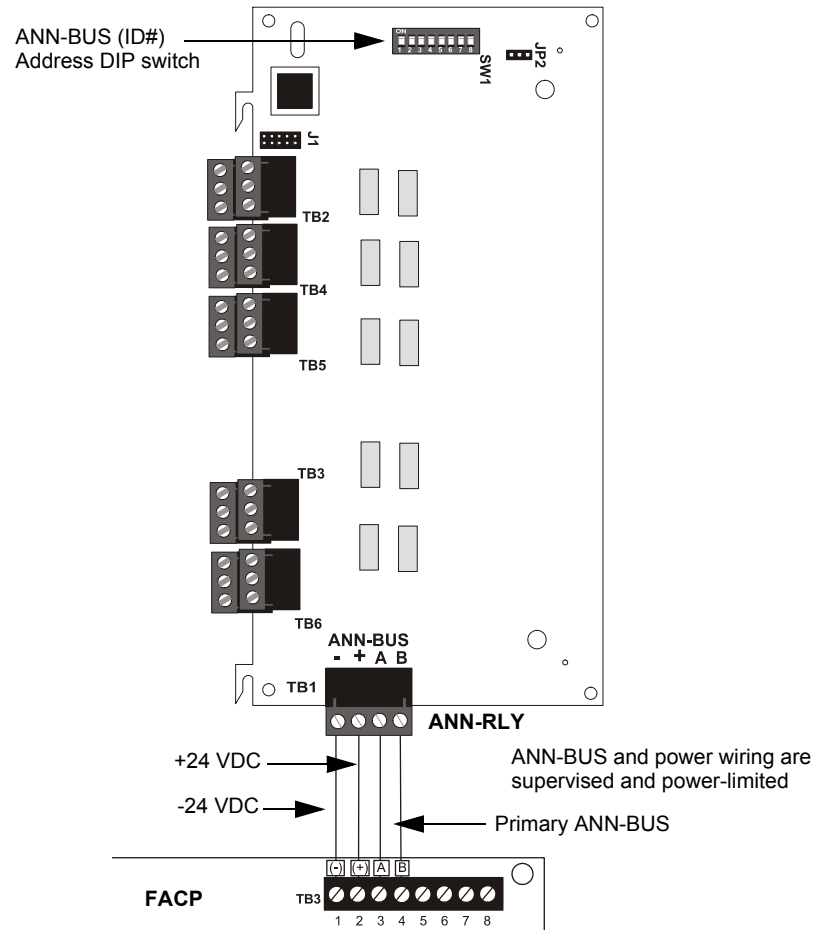

Figure 2.24 ANN-RLY Connection to FACP

Section 3: Programming

NOTICE TO USERS, INSTALLERS, AUTHORITIES HAVING JURISDICTION AND OTHER INVOLVED PARTIES			
This product incorporates field-programmable software. In order for the product to comply with the requirements in the Standard for Control Units and Accessories for Fire Alarm Systems, UL 864, certain programming features or options must be limited to specific values or not used at all as indicated below:			
Program feature or option	Permitted in UL 864? (Y/N)	Possible settings	Settings permitted in UL 864
Trouble Call Limit	N	Refer to "Trouble Call Limit (Dialer Runaway Prevention)" on page 123. Trouble Call Limit = 0 (factory default): unlimited calling to Central Station for any trouble condition Trouble Call Limit = 1 - 99: limits call for each unique trouble to from 1 to 99 within a 24 hour period	<i>Trouble Call Limit = 0</i> for unlimited Central Station trouble calls
Remote Download	Y	Refer to "Remote Download" on page 177. Remote Download - Proprietary No Remote Download - Proprietary Yes	Remote Download <i>Proprietary Yes</i> for Proprietary Installations Only

3.1 Programming Data Entry

Programming can be accomplished using the MS-9050UD keypad or by connecting an optional standard computer keyboard. The keyboard can be connected to the PS-2 connector J6 on the control panel main circuit board.

The information presented in this section refers to programming the MS-9050UD via the onboard keypad. If an optional computer keyboard is connected to the MS-9050UD main circuit board, the following table describes the keyboard keys which correspond to the onboard keypad keys.

Keypad Keys	Computer Keyboard Keys
1st Event	Home
CLR	Delete
ESC	Esc
RECALL	Insert
*	*
#	#
A - Z	A - Z
0 - 9	0 - 9
■ (on QZ key)	Space bar
—	—
/	/
•	•
←	←
→	→
↑	↑
↓	↓
ENTER	Enter
ACK/STEP	F1
SILENCE	F2
DRILL	F3
RESET	F4

3.2 User Programming

The MS-9050UD is completely field programmable and requires no special software skills. *While programming the MS-9050UD, the fire protection capabilities of the control panel are enabled.*

Site-specific programming may be accomplished in three ways:

- **Autoprogramming Feature** - This is a convenient method for quickly bringing the FACP addressable SLC devices on-line without the necessity of programming each device individually. Refer to “Autoprogram” on page 57 for a detailed description of Autoprogramming
- Manual programming or editing, using the FACP keypad or a PC keyboard
- Off-line Programming and Editing Feature - allows creation and editing of site-specific custom programs using a Windows-based computer. For programs requiring a large amount of data entry, this method may be preferred. A PK-CD programming kit can be ordered for this purpose

The *System All Normal* screen will be displayed in a programmed system with no active alarms, troubles or supervisories, as illustrated below:

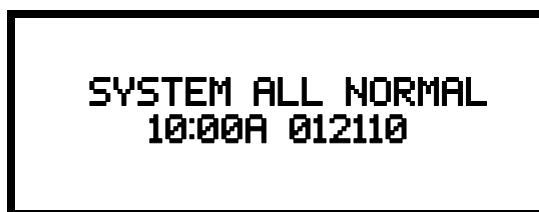

Read Status and Manual Dial mode can be entered while the panel is in any mode of operation. Manual Dial mode, however, cannot be entered while the panel is communicating with the Central Station. If an alarm or supervisory event exists at the panel, the event must be cleared before entering Programming mode. To access any of the programming or read status features, the *Enter* or *Mode* key must be pressed, which will cause the LCD to display the following:

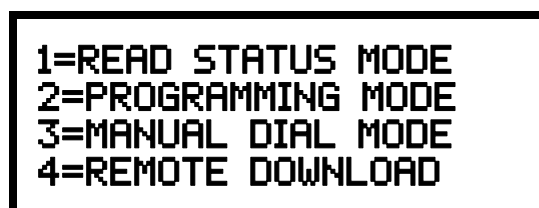

Pressing *1*, while this screen is being displayed, will cause the control panel to enter the Read Status Mode which allows the user to view the programmed features and status of the control panel. The Read Status feature is not password protected. Refer to “Read Status” on page 159 for a detailed description of this feature.

Pressing *2* will select user Programming Mode which may only be accomplished by an authorized person. After pressing *2*, a screen will prompt for a password. After entering the correct password, the user may select from a list of programming options.

Pressing *3* will select the Manual Dial Mode which allows the user to enter a troubleshoot mode of operation.

Pressing *4* will select Remote Download which allows the user to enable the remote programming option. Refer to “Remote Download” on page 177.

Exit Programming, Read Status, and Manual Dial Mode

The programmer can exit any mode by repeatedly pressing the keypad *ESC* (Escape) key until the display reads System All Normal. *Note that the data which is entered during Programming mode is not saved until the programmer exits this mode by repeatedly pressing the ‘ESC’ key. If the Reset key is pressed or power is lost before exiting Programming mode, all data just entered will be lost.*

User Programming Levels

There are two user programming levels:

- User Master Program Level 1 is used for programming panel specific data relating to device types, zoning, messages, control panel functions, etc.
- User Maintenance Program Level 2 is used by a qualified operator to access features such as Disable/Enable, View and Clear History, Walktest and System Time Change.

3.3 Initial Power-up

The following sections describe the initial programming procedures for a new system. The same procedures are used to modify programming in an existing system.

After completing the wiring of addressable devices to the SLC, apply power to the control panel. If the addressable devices have not yet been programmed into the FACP, their LEDs will not flash and the following trouble message will be displayed.

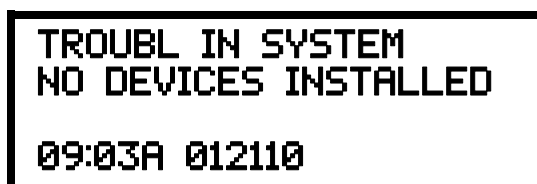

3.4 Programming Screens Description

Four options are available when the *Enter* key is pressed: Read Status, Programming, Manual Dial Mode and Remote Download. The Read Status and Programming options have multiple functions or features which may be chosen. To view all of the choices, it is necessary that the programmer scroll through a number of additional *subscreens*. These selections are displayed on multiple screens to make them more readable for the programmer. Refer to “Master Programming Level” on page 56, for additional information on the various screens.

The title of the main option screen will always be displayed at the top of the subscreens for the programmer’s convenience. If additional subscreens exist, an Up or Down arrow will be displayed in the upper right corner of the screen being viewed. The programmer can then press the keypad Up or Down arrow key to view the new subscreen. To select one of the choices in a screen, the programmer presses the keypad numerical key corresponding to the desired choice.

Note that subscreens may also have multiple options which require viewing more than one screen. The same process, as detailed in the previous paragraphs, is followed to view all option choices.

3.5 Programming and Passwords

There are two factory set programming passwords which will access the Programming screens as indicated in the following examples. From either of the screens, access to specific system and device features or programming may be obtained. All user programming entries are stored in non-volatile memory. The factory set passwords can be changed by the user as described in “Password Change” on page 136. If an invalid password is entered, the blinking cursor will return to the first password character position. To exit Programming, Read Status, Manual Dial mode or Remote Download at any time, press the *ESC* (Escape) key repeatedly. Note that Programming mode must be exited using the *ESC* key in order to store the program data entered during this mode. If the *Reset* key is pressed or power is lost before exiting Programming mode, the data just entered will not be saved.

To access user Programming mode, press the *Enter* or *Mode* key. The LCD will display the following:

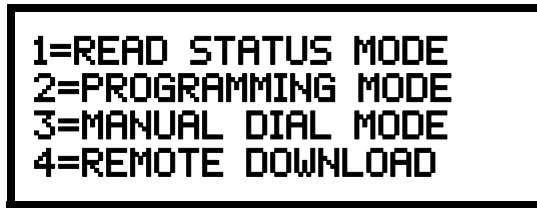

```
1=READ STATUS MODE
2=PROGRAMMING MODE
3=MANUAL DIAL MODE
4=REMOTE DOWNLOAD
```

To enter the user Programming mode, press 2. The display will read as follows:



```
PROGRAMMING
ENTER PASSWORD
*****
```

Entering the ***Master*** level password (default *00000*) will cause the following screen to appear:



```
PROGRAMMING
1=AUTOPROGRAM
2=POINT PROGRAM
3=ZONE SETUP
```

If the ***Maintenance*** level password (default *11111*) is entered, the following screen will appear:



```
PROGRAMMING
1=POINT PROGRAM
2=HISTORY
3=PROGRAM CHECK
```

Note that in the two preceding screens, an arrow appears to inform the programmer that additional options can be viewed by pressing the keypad *down* arrow key.

3.6 Master Programming Level

When the Master Program Level password is entered, the control panel will enter user Programming mode. In this mode, the piezo sounder remains off, the trouble relay is activated and the system Trouble LED flashes until Programming mode is exited. The following display will appear:



Programming Screen #1

The down arrow which appears in the display indicates that additional programming choices can be viewed by pressing the down arrow key on the keypad. If a down and up arrow appear in the display, pressing the 'down' arrow key will display the subsequent Programming Screens as illustrated below while pressing the 'up' arrow key will display the previous screen.



Programming Screen #2



Programming Screen #3



Programming Screen #4

3.6.1 Autoprogram

Pressing *I* while viewing Programming Screen #1, will select the Autoprogram option, which prompts the control panel to poll all devices installed on the SLC loop. The primary purpose of autoprogramming is to allow the installer a fast and easy way to bring the system on-line as quickly as possible. The first time the system is powered-up, it should be autoprogrammed.

```

PROGRAMMING
1=AUTO PROGRAM
2=POINT PROGRAM
3=ZONE SETUP

```

Programming Screen #1

If the system is already programmed and Autoprogram is initiated, the system will only add default values for newly installed devices.

When Autoprogram is selected, the control panel will begin autoprogramming the system by communicating with each addressable device installed on the SLC loop. While autoprogramming, the panel will display the following:

```

AUTOPROGRAM
AUTOPROGRAMMING!
PLEASE WAIT

```

Autoprogram Progress Screen

When Autoprogramming is completed, the control panel will display the type and quantity of each device installed on the SLC loop similar to the following display:

```

# OF DET LOOP1 022
# OF MON LOOP1 015
# OF CON LOOP1 010

```

Autoprogram Result Screen #1

In the preceding example, the display indicates that the SLC Loop has 22 addressable detectors, 15 monitor modules and 10 control modules installed.

Pressing the *ESC* key will return the display to Programming Screen #1.

3.6.2 Point Program

The Point Program option allows the programmer to add a new addressable device to an SLC loop, delete an existing device from a loop or change the programming for an existing device. Pressing *2*, while viewing Programming Screen #1, will select the Point Program option and display the following screen:

```

PROGRAMMING
1=AUTO PROGRAM
2=POINT PROGRAM
3=ZONE SETUP

```

Programming Screen #1

```

POINT PROGRAM
SELECT TYPE
1=DETECTOR
2=MODULE

```

Point Program Screen

Detector Programming

Pressing *I*, while viewing the Point Program Screen, will allow the programmer to add, delete or change the programming of an addressable detector. The following screen will be displayed by the control panel:



Detector Screen

■ Add Detector

Pressing *I* while viewing the Detector Screen will display the following screen which allows the programmer to add a new detector address to programming:



Add Detector Screen

A flashing cursor will appear in the position of the first asterisk to the left. The programmer keys in the three digit detector address, such as 005.

When the last digit is keyed-in, the following screen will be displayed:



Press the down arrow key to view additional choices. Press the number corresponding to the desired selection to program that type to the newly added detector.

When the type has been selected, the following screen will be displayed:



The programmer can continue adding detectors by pressing the *ESC* key which will return the display to the Add Detector Screen.

■ Delete Detector

```

DETECTOR
1=ADD
2=DELETE
3=EDIT

```

Detector Screen

Pressing 2 in the Detector Screen will display the Delete Detector Screen which allows the programmer to delete a specific detector:

```

DELETE DETECTOR
ENTER DETECTOR#
***

```

Delete Detector Screen

A flashing cursor will appear in the position of the first asterisk to the left. The programmer keys in the three digit detector address, such as 005. When the last digit is keyed-in, the following screen will be displayed:

```

DELETE DETECTOR
DETECTOR#      005
IS DELETED

```

The programmer can continue deleting detectors by pressing the *ESC* key which will return the display to the Delete Detector Screen.

■ Edit Detector

The programmer can change a detectors existing or factory default programming by pressing 3 in the Detector Screen. The following screen will be displayed:

```

EDIT DETECTOR
ENTER POINT ADDRESS
***

```

Edit Detector Screen

A flashing cursor will appear in the position of the first asterisk to the left. The programmer keys in the three digit detector address, such as 017.

When the last digit is keyed-in, if the selected address has not been added to programming, a screen showing information about a device that is installed with a lower address, closest to the selected address, will be displayed.

If no detectors have been installed on the loop, the following will be displayed:

```

NO DETECTOR
INSTALLED

```

Edit Detector Screen #1

If the selected address has been added to programming, device summary screens will be displayed. These screens allow the programmer to view all device settings at a single glance. Pressing the left or right arrow keys will allow the programmer to rapidly view the devices at the previous or next address (if installed).

If a detector (such as a photoelectric detector) with the selected address is not physically installed on the SLC or has a communication fault but the address is programmed in the system, the following screen will be displayed:

```

TROUBL SMOKE<PHOTO>
<ADJ><NOUN>
          *   ZNNN
          1D017
  
```

Edit Detector Screen #1

If the selected address has been added to programming and a detector (such as a photoelectric detector) with the selected address is physically installed on the SLC and is communicating with the control panel, the following will be displayed:

```

NORMAL SMOKE <PHOTO>
<ADJ><NOUN>
          V   ZNNN
          1D017
  
```

Edit Detector Screen #1

To change the programming for the displayed detector, press the keyboard 'down' arrow key to view the Edit Detector screens.

In the preceding example:

- ✓ Normal - indicates that the detector with the selected address is physically installed on the SLC and communicating with the control panel (enabled)
- ✓ <ADJ><NOUN> - represents the adjective and noun, which have been programmed, describing the location of the displayed device
- ✓ ZNNN - represents the first of five possible software zones that the detector is assigned to (NNN = the three digit zone number from 000 - 019)
- ✓ V or * - indicates whether or not alarm verification is enabled (V = alarm verification enabled and * = alarm verification disabled)
- ✓ 1D017 - represents the Loop, Device type and Device address (1 = SLC Loop, D=Detector and 017 = Detector Address 017)

The following examples show the editing of a photoelectric smoke detector with address 017, located on the SLC loop:



Edit Detector Screen #2



Edit Detector Screen #3

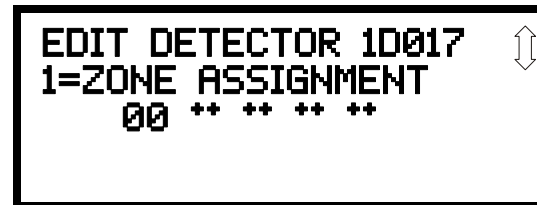

Edit Detector Screen #4



Edit Detector Screen #5

Enable/Disable Detector



Edit Detector Screen #2

To Enable or Disable the detector, press the *I* key while viewing the Edit Detector Screen #2. Each press of the key will toggle the screen between *Enabled Yes* and *Enabled No*. If *Enabled No* is selected, the detector will not be polled by the control panel, preventing the detector from reporting alarms and troubles to the panel. The control panel will display the device type and address which has been disabled and will turn on the Trouble LED.

Type

To select the type of detector being programmed, press the 2 key while viewing the Edit Detector Screen #2. This will cause the control panel to display the following Detector Type Screen:



Edit Detector Screen #2



Detector Type Screen #1

Pressing the down arrow key will display additional detector types as indicated in the following table.

Detector Type	Action When Activated
Smoke Photo	Fire Alarm
User-Defined-1	same as previous (Smoke Photo)
Smoke Ion	Fire Alarm
User-Defined-2	same as previous (Smoke Ion)
Heat Detect	Fire Alarm
User-Defined-3	same as previous (Heat Detect)
Smoke DuctP	Fire Alarm
User-Defined-4	same as previous (Smoke DuctP)
Photo w/Heat	Fire Alarm
User-Defined-5	same as previous (Photo w/Heat)
Duct Superv	Supervisory, latching
User-Defined-6	same as previous (Duct Superv)
Photo Superv	Supervisory, latching
User-Defined-7	same as previous (Photo Super)
future	not used

While viewing any Detector Type screen, select the type of detector being programmed by pressing the corresponding keyboard number key. The display will return to Edit Detector Screen #2 and indicate the selection next to the Type option.



NOTE: If a detector is selected to be a SUPERV DUCTP type, it will function like a supervisory point not a fire alarm point. The supervisory LED and supervisory relay will activate, not the fire alarm LED or alarm relay, if the detector senses smoke.

Verification

Alarm verification is used to confirm that a smoke detector activation is a true alarm condition and not a false alarm. This feature is selected by pressing 3 while viewing the Edit Detector Screen #2 so that the display reads *Verification On*. Each time the 3 key is pressed, the display will toggle between *Verification On* and *Verification Off*. For a detailed description, refer to “Alarm Verification (None or One Minute)” on page 158.

Walktest

```

EDIT DETECTOR
1=WALKTEST
2=PAS
3=PRE-SIGNAL

```

Edit Detector Screen #3

The Walktest feature allows one person to test the system devices without the necessity of manually resetting the control panel after each device activation. To enable a device for the Walktest feature, press *1* while viewing the Edit Detector Screen #3 until the display reads *Walktest Yes*. Each press of the *1* key will cause the display to toggle between *Walktest Yes* and *Walktest No*. Refer to “Walktest” on page 158.

PAS

The PAS (Positive Alarm Sequence) option will program the detector to delay panel activation (including alarm relay and communicator) for a period of 15 seconds plus a programmable time of up to 3 minutes. Zone 17, however, will activate immediately and may be used to connect a signaling device to indicate PAS activation (*do not use a Notification Appliance Circuit for this purpose*). To enable the PAS feature, press *2* while viewing the Edit Detector Screen #3 until the display reads *PAS Yes*. Each press of the *2* key will cause the display to toggle between *PAS Yes* and *PAS No*. Refer to “Positive Alarm Sequence” on page 156.

For example, if a detector with address 005 is to be configured for PAS operation:

- ✓ Select *PAS Yes* when editing the detector set to address 005
- ✓ Program the desired zone or zones to be activated by this detector, in this example Z001
- ✓ Program an output, such as a control module that is to be activated by detector 005 by assigning the same zone to it; in this example Z001
- ✓ Program an output, such as a control module, for PAS activation by assigning zone Z17 to it. This control module may be connected to a signaling device used to indicate a PAS condition (*do not use a Notification Appliance Circuit for this purpose*)
- ✓ Enable zones Z001 and Special Purpose Zone PAS 17 and set the PAS delay timer to some value

With the preceding program settings, when the detector with address 005 is activated, zone Z17 will cause its associated control module to activate immediately, sounding the connected PAS signaling device. Following the PAS delay time, zone Z001 will cause its associated control module to activate and the control panel will initiate an alarm condition.

Note that a detector can be enabled for either PAS or Pre-signal but not both.

Pre-signal

The Pre-signal option programs the detector to delay panel activation for a preprogrammed time delay of up to three minutes while allowing for visual verification by a person. Note that the alarm relay and communicator will respond to the initial alarm immediately. In addition, Zone 18 will activate. This zone can be programmed to a control module which may be used to activate a sounder or indicator which the installer designates as a Presignal indication (*do not use a Notification Appliance Circuit for this purpose*). To enable the Pre-signal feature, press *3* while viewing Edit Detector Screen #3 until the display reads *Pre-signal Yes*. Each press of the *3* key will cause the display to toggle between *Pre-signal Yes* and *Pre-signal No*. Refer to “Presignal” on page 156.

For example, if a detector with address 005 is to be configured for Pre-Signal operation:

- ✓ Select *Pre-signal Yes* when editing the detector set to address 005
- ✓ Program the desired zone or zones to be activated by this detector, in this example Z001
- ✓ Program an output, such as a control module that is to be activated by detector 005 by assigning the same zone to it; in this example Z001
- ✓ Program an output, such as a control module, for Pre-signal activation by assigning zone Z18 to it. This control module may be connected to a signaling device used to indicate a Pre-signal condition (*do not use a Notification Appliance Circuit for this purpose*)
- ✓ Enable zones Z001 and Special Purpose Zone Pre-signal 18 and set the Pre-signal delay timer to some value

```

EDIT DETECTOR
1=WALKTEST
2=PAS
3=PRE-SIGNAL

```

Edit Detector Screen #3

With the preceding program settings, when the detector with address 005 is activated, zone Z18 will cause its associated control module to activate immediately, sounding the connected signaling device to indicate the Pre-signal condition. Following the Pre-signal delay time, zone Z001 will cause its associated control module to activate and the control panel will initiate an alarm condition.

Note that a detector can be enabled for either PAS or Pre-signal but not both.

Zone Assignment



Edit Detector Screen #4

A maximum of five zones can be programmed to each addressable detector. Pressing *I* while viewing Edit Detector Screen #4 displays the following screen:

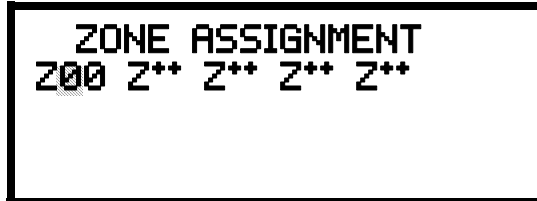

Zone Assignment Screen

Note that *Z*** represents the Zone Number(s) corresponding to this device. The factory default for an unprogrammed device is *Z00* for general alarm zone. A flashing cursor will appear on the first *0* to the left. Enter the two digit number corresponding to the zone that is to be assigned to this device. The cursor moves to the next *Z*** designation. Continue entering zone assignments or the remaining zones can be left blank or programmed as general alarm zone *Z00*. When all desired changes have been made, press the Enter key to store the zone assignments. The display will return to the Edit Detector Screen #4. Note that the left and right arrow keys can be used to navigate through the zones and the *CLEAR* key can be used to quickly clear a zone.

Adjective/Noun

The Adjective/Noun selection allows the programmer to enter specific descriptors about the detector currently being programmed. Pressing *I* while viewing Edit Detector Screen #5 will cause the following screen to be displayed:



Edit Detector Screen #5



Adjective/Noun Screen

1=STANDARD ADJECTIVE
 2=STANDARD NOUN
 3=CUSTOM ADJECTIVE
 4=CUSTOM NOUN

Adjective/Noun Screen

Pressing 1 while viewing the Adjective/Noun Screen will cause the following screen(s) to be displayed. Note that the keyboard *down* arrow key must be pressed to see all the Adjective screens. Press the number corresponding to the adjective that is to be used as a descriptor for the location of the detector currently being programmed. When an adjective has been selected, it will appear at the top of the display as indicated by the asterisks.

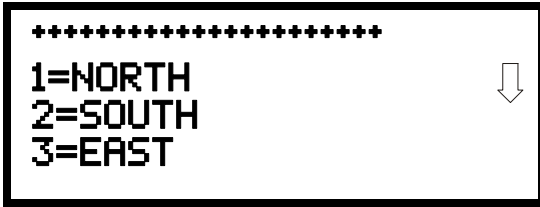

Adjective Screen #1



Adjective Screen #2

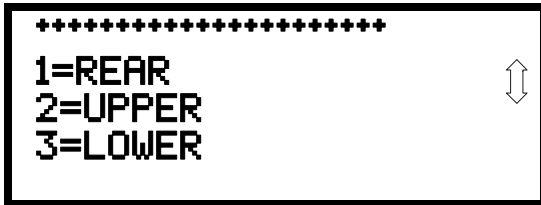

Adjective Screen #3



Adjective Screen #4

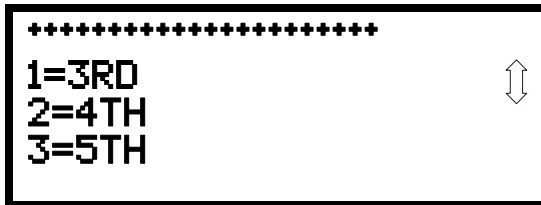

Adjective Screen #5

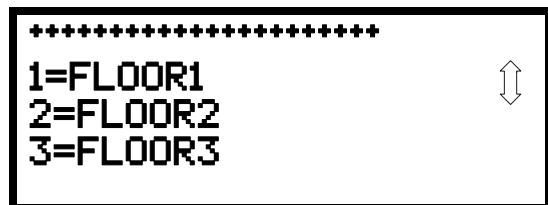

Adjective Screen #6

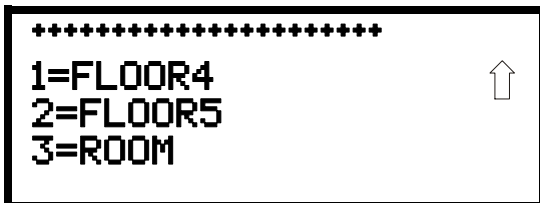

Adjective Screen #7

1=STANDARD ADJECTIVE
 2=STANDARD NOUN
 3=CUSTOM ADJECTIVE
 4=CUSTOM NOUN

Adjective/Noun Screen

Pressing 2 while viewing the Adjective/Noun Screen will cause the following screen(s) to be displayed. Note that the keyboard *down* arrow key must be pressed to see all the Noun screens. Press the number corresponding to the noun that is to be used as a descriptor for the location of the detector currently being programmed. When a noun has been selected, it will appear at the top of the display as indicated by the asterisks.



Noun Screen #1

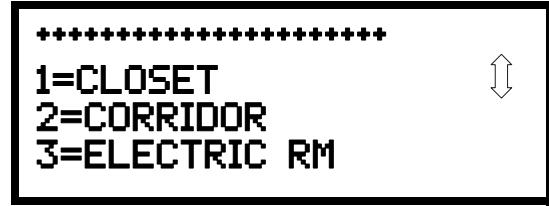

Noun Screen #2

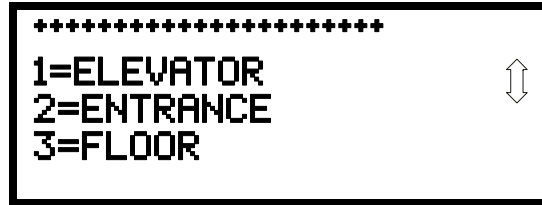

Noun Screen #3



Noun Screen #4



Noun Screen #5



Noun Screen #6



Noun Screen #7

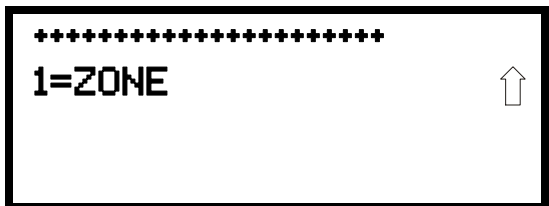

Noun Screen #8

1=STANDARD ADJECTIVE
 2=STANDARD NOUN
 3=CUSTOM ADJECTIVE
 4=CUSTOM NOUN

Adjective/Noun Screen

EDIT DETECTOR
 1=ADJECTIVE/NOUN
 2=DESCRIPTION

Edit Detector Screen #5

Pressing 3 or 4 while viewing the Adjective/Noun Screen will display screens similar to the previous Adjective and Noun Screens. The new screens will list custom Adjectives and Nouns which have been programmed into the control panel by the user utilizing the PK-CD programming kit. These descriptors are selected as described in the previous sections.

Description

The Description selection allows the programmer to enter additional information about the detector currently being programmed. This information will be displayed as part of the device label on the display. Pressing 2 while viewing Edit Detector Screen #5 will cause the following screen to be displayed:



Adjective/Noun Screen

A flashing cursor will appear at the first asterisk to the left. The programmer can enter additional descriptive information about the device being programmed. This information will appear on the display along with the standard device label information.

A maximum of 20 characters (including spaces) can be entered. To enter alphanumeric characters from the keypad, repeatedly press the appropriate key until the desired character is displayed in the first position. For example, to enter the letter *B*, press the 2 (ABC) key three times to toggle through the characters *I*, *A*, and *B*. Press the right arrow key to move the cursor one position to the right and repeat the process to enter the next character. To enter a space, press the * (QZ) key four times until a blank appears in the desired position. When all characters have been entered, press the Enter key to store the information. The display will return to the Edit Detector Screen #5, displaying the new information at the bottom of the screen.

Recall/Increment Function

In addition, the user may use the Recall/Increment function at any time when the cursor is on the first letter of the Description, Adjective or Noun field as follows:

- If the zero key is pressed, a 0 is placed in the first letter position.
- If the zero key is then pressed a second time with no intervening key actions, the entire field is replaced with the field entered *for the previous device programmed*, and the cursor moves to the last character of the field (Recall function). The Recalled Adjective or Noun field may now be changed letter-by-letter.
- If the zero key is pressed again with no other intervening key actions and the last character in the field is a number 0-9, the number is incremented by one (9 will change to 0). If the last character is a letter, it changes to a 0.
- The above increment function may be repeated with each press of the zero key.

As an example, the user could quickly enter 'FLR_3_ROOM_305' as follows:

1. The cursor is on the first letter of the Adjective field. Press the zero key twice to display *FLR_3*.
2. With the cursor on the first letter of the Noun field, press the zero key twice to recall the display *ROOM_304*. The cursor automatically jumps from the first to the last letter of the Noun field.

3. With the cursor on the last letter of the Noun field, press the zero key again to increment the room number to 305.
4. Press the Enter key to store the information.

Module Programming

```
POINT PROGRAM
SELECT TYPE
1=DETECTOR
2=MODULE
```

Point Program Screen #2

Pressing 2, while viewing Point Program Screen #2, will allow the programmer to add, delete or change the programming of an addressable module. The following screen will be displayed by the control panel:

```
MODULES
1=ADD
2=DELETE
3=EDIT
```

Modules Screen

■ Add Module

Pressing 1 while viewing the Modules Screen will display the following screen which allows the programmer to add a new module address to programming:

```
ADD MODULE
ENTER MODULE#
***
█
```

Add Module Screen #1

A flashing cursor will appear in the position of the first asterisk to the left. The programmer keys in the three digit module address, such as 006.

When the last digit is keyed-in, the following screen will be displayed:

```
ADD MODULE
1=CONTROL
2=MONITOR
```

Add Module Screen #2

Pressing *1* for Control Module or *2* for Monitor Module will cause the following screen to be displayed:

```

      ADD MODULE
MODULE#      006
IS ADDED
  
```

Add Module Screen #3

The programmer can continue adding modules by pressing the *ESC* or left arrow key which will return the display to the Add Module Screen #1.

■ Delete Module

Pressing *2* in the Modules Screen will display the Delete Module Screen which allows the programmer to delete a specific module:

```

MODULES
1=ADD
2=DELETE
3=EDIT
  
```

Modules Screen

```

      DELETE MODULE
ENTER MODULE#
***
  
```

Delete Module Screen

A flashing cursor will appear in the position of the first asterisk to the left. Using the panel keypad, key in the module address such as *006*. When the last digit is keyed in, the following confirmation that the module has been deleted will be displayed:

```

      DELETE MODULE
MODULE#      006
IS DELETED
  
```

■ Edit Module Screen for Monitor Module

The programmer can change a modules existing or factory default programming by pressing *3* in the Modules Screen. The following screen will be displayed:

```

      EDIT MODULE
ENTER MODULE ADDRESS
***
  
```

Edit Module Screen

A flashing cursor will appear in the position of the first asterisk to the left. The programmer keys in the three digit module address, such as *012*.

When the last digit is keyed-in, if the selected address has not been added to programming, a screen showing information about a device that is installed with a lower address, closest to the selected address, will be displayed. If no modules are installed on the loop, the following screen will be displayed:

```

NO MODULE
INSTALLED

```

Edit Module Screen

If the selected address has been added to programming but a module (such as a monitor module) with the selected address is not physically installed on the SLC or has a communication fault, the following screen will be displayed:

```

TROUBL MONITOR
<ADJ><NOUN>
      ZNNN
*    1M012

```

If the selected address has been added to programming and a module (such as a monitor module) with the selected address is physically installed on the SLC and is communicating with the control panel, the following screen will be displayed:

```

NORMAL MONITOR
<ADJ><NOUN>
      ZNNN
W    1M012

```

To change the programming for the displayed module, press the keyboard down arrow key to view the following Edit Monitor screens.

In the preceding example:

- ✓ Normal - indicates that the module with the selected address is physically installed on the SLC and communicating with the control panel (enabled)
- ✓ <ADJ><NOUN> - represents the adjective and noun, which have been programmed, describing the location of the displayed device
- ✓ ZNNN - represents the first of five possible software zones that the module is assigned to (NNN = the two digit zone number from 000 - 019)
- ✓ 1M012 - represents the Loop, Device type and Device address (1 = SLC Loop 1, M=Module and 012 = Module Address 012)
- ✓ W or * - indicates whether or not the device is programmed for Walktest (W = programmed for walktest, * = not programmed for walktest).

If the selected address corresponds to a control module, a screen displaying information about the control module with the selected address will be displayed as shown in “Edit Module Screen for Control Modules” on page 78.

If the selected address corresponds to a monitor module, a screen displaying information about the module with the selected address will be displayed as illustrated in the following:



Edit Monitor Screen #2



Edit Monitor Screen #3

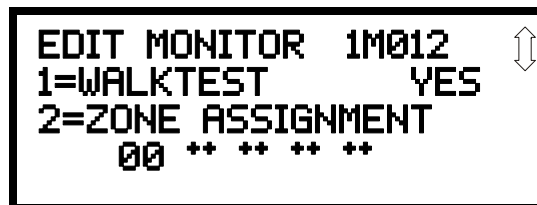

Edit Monitor Screen #4



Edit Monitor Screen #5

Enable/Disable Module

To Enable or Disable the monitor module, press the *I* key while viewing the Edit Module Screen #2. Each press of the key will toggle the screen between *Enabled Yes* and *Enabled No*. If *Enabled No* is selected, the module will not be polled by the control panel, preventing the module from reporting alarms and troubles to the panel. The control panel will indicate a system trouble condition if any devices are disabled.

```

EDIT MONITOR
1=ENABLED
2=TYPE MONITOR

```

Edit Monitor Screen #2

Type Monitor

Using the PK-CD Upload/Download utility program, unique user-defined monitor types can be created and loaded into the FACP for later use. The FACP response to the activation of a user-defined type is the same as most previous standard types in the list, thus allowing a variety of user-defined types and responses. To select the type of monitor module being programmed, press the 2 key while viewing the Edit Monitor Screen #2. This will cause the control panel to display the first Monitor Type Screen as illustrated below

```

MONITOR TYPE
1=PULL-STATION
2=USER-DEFINED-1
3=WATERFLOW

```

Monitor Type Screen #1

To view additional Monitor Type Screens, press the down arrow key. While viewing one of the Monitor Type screens, select the type of monitor module being programmed by pressing the corresponding keypad number key. The display will return to the Edit Monitor Screen #2 which will show the new type selection. The following table lists all of the Monitor Types available for programming and their respective functions.

Monitor module type selection will affect the function of the point as follows:

Monitor Type	Action When Activated
Pull-Station	Fire Alarm
User-Defined-1	Fire Alarm
Waterflow	Fire Alarm Delayed (uses waterflow delay)
User-Defined-2	Fire Alarm Delayed (uses waterflow delay)
Monitor	Fire Alarm
User-Defined-3	Fire Alarm
Future Use	Future Use
Future Use	Future Use
Smoke-Conventional ^{1, 2}	Fire Alarm
User-Defined-5 ²	Fire Alarm
Heat-Conventional ²	Fire Alarm
User-Defined-6 ²	Fire Alarm
Medic-Alert ³	Piezo, latching
User-Defined-7	Piezo, latching
Hazard-Alert ³	Piezo, latching
User-Defined-8	Piezo, latching
Tornado-Alert ³	Piezo, latching
User-Defined-9	Piezo, latching
Future Use	Future Use
Future Use	Future Use
Tamper	Supervisory, nonlatching (tracking)
User-Defined-11	Supervisory, nonlatching (tracking)
Supervisory	Supervisory, latching
User-Defined-12	Supervisory, latching
Supervisory-AR ⁴	Supervisory, nonlatching (tracking)
User-Defined-13	Supervisory, nonlatching (tracking)
HVAC OVERRIDE ⁵	Switch Supervisory, nonlatching (tracking)
Power-Monitor	AC Fault

Table 3.1 Monitor Types

User-Defined-14	AC Fault
Trouble-Monitor	Trouble
User-Defined-15	Trouble
Proc-Mon ³	Piezo
User-Defined-16	Piezo
Procmon-AR ^{3,4}	Piezo, nonlatching (tracking)
User-Defined-17	Piezo, nonlatching (tracking)
Future Use	Future Use
Future Use	Future Use
Ack-Switch	Acts like panel Acknowledge Key
Sil-Switch	Acts like panel Alarm Silence Key
Reset-Switch	Acts like panel Reset Key
Drill-Switch	Acts like panel Drill Key
PAS-Bypass	PAS Disable
HVAC RESTART ⁵	Switch
Drill-Switch AR ⁴	Acts like panel Drill Key, nonlatching (tracking) ⁶

Table 3.1 Monitor Types

- 1 Conventional 2-wire smoke detectors may be powered using an external power supply with an SLC Control Relay Module programmed for Resettable Power operation. A *Control Relay Module set to the Resettable Power type will follow the main circuit board 24 VDC resettable power unless the control module is disabled.*
- 2 Use only these Monitor Type IDs for the Zone Modules (MMF-302). The Zone Modules will not function correctly if any other Type ID is used.
- 3 Combination systems employing these non-fire monitor types require the SLC loop to be programmed by the installer for Style 4 operation and isolator modules must be employed on each non-fire branch of the SLC as per Figure 13 in the Fire-Lite SLC Wiring Manual (document number 51309). Fire and non-fire devices must not be used on the same SLC branch.
- 4 For entries ending in AR, AR refers to AutoResettable.
- 5 For HVAC RESTART AND HVAC OVERRIDE descriptions, refer to “HVAC Control” on page 201.
- 6 Drill Switch Auto-Resettable turns on the NACs and any control module mapped to the Drill Switch zone.



Edit Monitor Screen #3

Pre-signal

To enable the Pre-signal feature, press *I* while viewing Edit Monitor Screen #3 until the display reads *Pre-signal Yes*. Each press of the *I* key will cause the display to toggle between *Pre-signal Yes* and *Pre-signal No*. Refer to “Presignal” on page 156 for additional information.

Walktest

The Walktest feature allows one person to test the system devices without the necessity of manually resetting the control panel after each device activation. To enable devices, which are connected to a monitor module, for the Walktest feature, press *I* while viewing the Edit Monitor Screen #4 until the display reads *Walktest Yes*. Each press of the *I* key will cause the display to toggle between *Walktest Yes* and *Walktest No*. Refer to “Walktest” on page 158 for additional information.



Edit Monitor Screen #4

Zone Assignment

A maximum of five zones can be programmed to each addressable monitor module. Pressing 2 while viewing Edit Monitor Screen #4 displays the following screen:

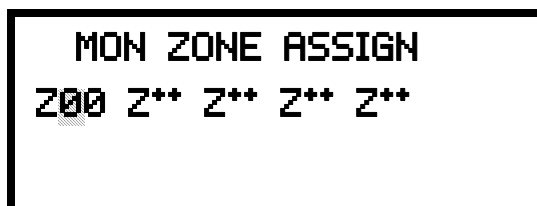

Zone Assignment Screen

Note that Z** represents the Zone Number(s) corresponding to this device. The factory default for an unprogrammed device is Z00 for general alarm zone. A flashing cursor will appear on the first 0 to the left. Enter the two digit number corresponding to the zone that is to be assigned to this device. The cursor moves to the next Z** designation. Continue entering zone assignments or the remaining zones can be left blank or programmed as general alarm zones Z00. When all desired changes have been made, press the Enter key to store the zone assignments. The display will return to the Edit Monitor Screen #4.

```
EDIT MONITOR
1=ADJECTIVE/NOUN
2=DESCRIPTION
*****
```

Edit Monitor Screen #5

Adjective/Noun

The Adjective/Noun selection allows the programmer to enter specific descriptors about the monitor module currently being programmed. Pressing 1 while viewing Edit Monitor Screen #5 will cause the following screen to be displayed:

```
1=STANDARD ADJECTIVE
2=STANDARD NOUN
3=CUSTOM ADJECTIVE
4=CUSTOM NOUN
```

Adjective/Noun Screen

1=STANDARD ADJECTIVE
2=STANDARD NOUN
3=CUSTOM ADJECTIVE
4=CUSTOM NOUN

Adjective/Noun Screen

Pressing 1 while viewing the Adjective/Noun Screen will cause the following screen(s) to be displayed. Note that the keyboard *down* arrow key must be pressed to see all the Adjective screens. Press the number corresponding to the adjective that is to be used as a descriptor for the location of the monitor module currently being programmed.



Adjective Screen #1



Adjective Screen #2



Adjective Screen #3



Adjective Screen #4

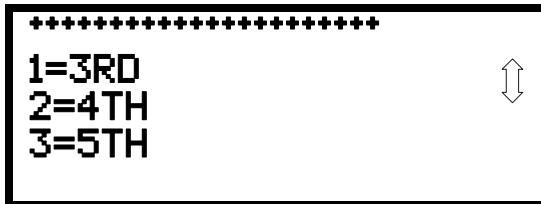

Adjective Screen #5

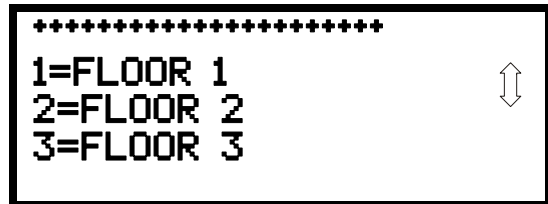

Adjective Screen #6

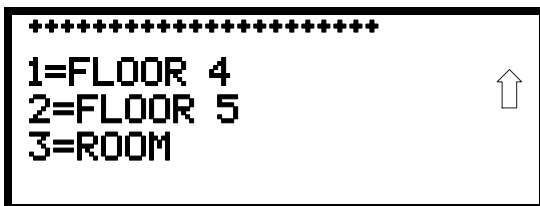

Adjective Screen #7

1=STANDARD ADJECTIVE
 2=STANDARD NOUN
 3=CUSTOM ADJECTIVE
 4=CUSTOM NOUN

Adjective/Noun Screen

Pressing 2 while viewing the Adjective/Noun Screen will cause the following screen(s) to be displayed. Note that the keyboard *down* arrow key must be pressed to see all the Noun screens. Press the number corresponding to the noun that is to be used as a descriptor for the location of the monitor module currently being programmed.

```
*****
1=BASEMENT
2=BOILER RM
3=CLASSROOM
```

Noun Screen #1

```
*****
1=CLOSET
2=CORRIDOR
3=ELECTRIC RM
```

Noun Screen #2

```
*****
1=ELEVATOR
2=ENTRANCE
3=FLOOR
```

Noun Screen #3

```
*****
1=GARAGE
2=HALLWAY
3=HVAC RM
```

Noun Screen #4

```
*****
1=KITCHEN
2=LOBBY
3=OFFICE
```

Noun Screen #5

```
*****
1=PATIENT
2=RESTROOM
3=ROOM
```

Noun Screen #6

```
*****
1=STAIRWAY
2=STOREROOM
3=WING
```

Noun Screen #7

```
*****
1=ZONE
```

Noun Screen #8

Pressing 3 or 4 while viewing the Adjective/Noun Screen will display screens similar to the previous Adjective and Noun Screens. The new screens will list Custom Adjectives and Nouns which have been programmed into the control panel using the PK-CD. These descriptors are selected as described in the previous sections.

```

EDIT MONITOR
1=ADJECTIVE/NOUN
2=DESCRIPTION
*****

```

Edit Monitor Screen #5

Description

The Description selection allows the programmer to enter additional information about the monitor module currently being programmed. This information will be displayed as part of the device label on the LCD display. Pressing 2 while viewing Edit Monitor Screen #5 will cause the following screen to be displayed:



Adjective/Noun Screen

A flashing cursor will appear at the first asterisk to the left. The programmer can enter additional descriptive information about the device being programmed. This information will appear on the LCD display along with the standard device label information.

A maximum of 20 characters (including spaces) can be entered. To enter alphanumeric characters from the keypad, repeatedly press the appropriate key until the desired character is displayed in the first position. For example, to enter the letter *B*, press the 2 (*ABC*) key three times to toggle through the characters 2, *A* and *B*. Press the right arrow key to move the cursor one position to the right and repeat the process to enter the next character. To enter a space, press the * (*QZ*) key four times until a blank appears in the desired position. When all characters have been entered, press the Enter key to store the information. The display will return to the Edit Monitor Screen #4, displaying the new information at the bottom of the screen.

Recall/Increment Function

In addition, the user may use the Recall/Increment function at any time when the cursor is on the first letter of the Adjective or Noun field as follows:

- If the zero key is pressed, a 0 is placed in the first letter position.
- If the zero key is then pressed a second time with no intervening key actions, the entire Adjective field is replaced with the field entered *for the previous device programmed*, and the cursor moves to the last character of the field (Recall function). The Recalled Adjective or Noun field may now be changed letter-by-letter.
- If the zero key is pressed again with no other intervening key actions and the last character in the field is a number 0-9, the number is incremented by one (9 will change to 0). If the last character is a letter, it changes to a 0.
- The above increment function may be repeated with each press of the zero key.

As an example, the user could quickly enter 'FLR_3_ROOM 305' as follows:

1. The cursor is on the first letter of the Adjective field. Press the zero key twice to display *FLR_3*.
2. With the cursor on the first letter of the Noun field, press the zero key twice to recall the display *ROOM_304*. The cursor automatically jumps from the first to the last letter of the Noun field.
3. With the cursor on the last letter of the Noun field, press the zero key again to increment the room number to *305*.
4. Press the Enter key to store the information.

```

MODULES
1=ADD
2=DELETE
3=EDIT

```

Modules Screen

■ Edit Module Screen for Control Modules

The programmer can change a module's existing or factory default programming by pressing 3 in the Modules Screen. The following screen will be displayed:

```

          EDIT MODULE
        ENTER MODULE ADDRESS
        ***

```

Edit Module Screen

A flashing cursor will appear in the position of the first asterisk to the left.

The programmer keys in the three digit module address, such as 002. When the last digit is keyed-in, if the selected address corresponds to a *control* module, a screen displaying information about the control module with the selected address will be displayed as illustrated in the following:

```

NORMAL      CONTROL  ↓
      <ADJ><NOUN>
          ZNNN
        SW  1M002

```

Edit Control Screen #1

In the preceding example:

- ✓ Normal - indicates that the module with the selected address is physically installed on the SLC and communicating with the control panel (enabled).
- ✓ <ADJ><NOUN> - represents the adjective and noun, which have been programmed, describing the location of the displayed device.
- ✓ Control - indicates that the selected module is a control module.
- ✓ S or * - represents Silenceable (S) or Nonsilenceable (*).
- ✓ W or * - represents Waterflow Timer Delay (W = Waterflow Timer Delay enabled, * = Waterflow Timer Delay disabled).
- ✓ ZNNN - represents the first of five possible software zones that the module is assigned to (NNN = the three digit zone number from 000 - 019).
- ✓ 1M002 - represents the Loop, Device type and Device address (1 = SLC Loop, M=Module, and 002 = Module Address 02).

To change the programming for the displayed module, press the keyboard *down* arrow key to view the following Edit Control screens:

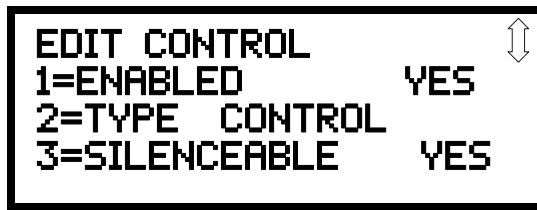

Edit Control Screen #2

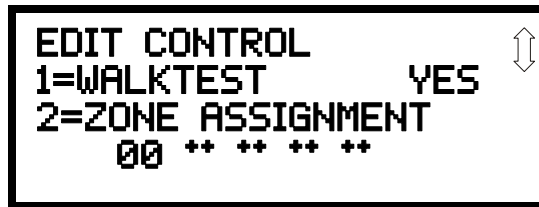

Edit Control Screen #3



Edit Control Screen #4

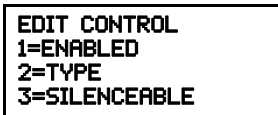

Edit Control Screen #2

Enable/Disable Module

To Enable or Disable the control module, press the *1* key while viewing the Edit Control Screen #2. Each press of the key will toggle the screen between *Enabled Yes* and *Enabled No*. If *Enabled No* is selected, the module will not be polled by the control panel, preventing the module from activating its output devices. The control panel will indicate a system trouble condition and the Disable LED will turn on if any devices are disabled.

Type

To select the type of control module being programmed, press the *2* key while viewing the Edit Control Screen #2. This will cause the control panel to display the following Control Type Screens:

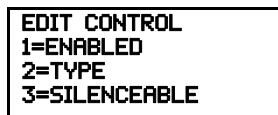

Edit Control Screen #2

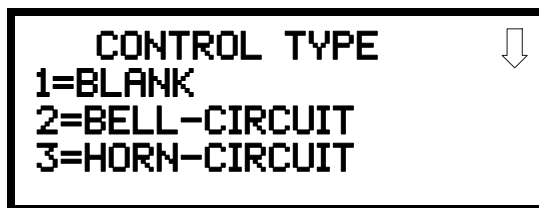

Control Type Screen #1

While viewing one of the Control Type screens, select the type of control module being programmed by pressing the corresponding keypad number key. The display will return to the Edit Control Screen #2 and indicate the new type selection.



NOTE: A control relay module set to the Resettable Power type will follow the main circuit board 24 VDC resettable power unless the control relay module is disabled.

The following table contains control module type codes and their functions which are displayed in the Control Type screens:

Control Type	Special Function
Blank	NAC Type - Supervised
Bell Circuit	NAC Type - Supervised
Horn Circuit	NAC Type - Supervised
Sounders	NAC Type - Supervised
Relay	Relay Type - Ignore Open Circuit
Strobe Circuit	NAC Type - Supervised
Control	NAC Type - Supervised
Resettable Power ¹	Relay Type - Ignore Open Circuit
HVAC SHUTDN ²	Relay Type - Ignore Open Circuit

- 1 When using a control relay module to supply resettable power to conventional 2-wire smoke detectors, the addressable monitor module must be programmed for “Smoke Conventional” operation.
- 2 For the HVAC SHUTDN description, refer to Section F.1, “Control Module Operation”, on page 201.

Silenceable

The Silenceable selection allows the programmer to select whether output devices connected to the control module can be silenced, either by pressing the Alarm Silence key or by enabling Autosilence. Pressing the 3 key while viewing Edit Control Screen #2 will enable the Silenceable feature causing the display to read *Silenceable Yes*. Repeated presses of the 3 key will cause the display to toggle between *Silenceable Yes* and *Silenceable No*.

Note that nonsilenceable outputs will not be activated for Fire Drill.

Walktest

The Walktest feature allows one person to test the system devices without the necessity of manually resetting the control panel after each device activation. To enable devices, which are connected to a control module, for the Walktest feature, press 1 while viewing the Edit Control Screen #3 until the display reads *Walktest Yes*. Each press of the 1 key will cause the display to toggle between *Walktest Yes* and *Walktest No*. Refer to “Walktest” on page 158 for additional information.

```

EDIT CONTROL
1=ENABLED
2=TYPE
3=SILENCEABLE
    
```

Edit Control Screen #2

```

EDIT CONTROL
1=WALKTEST
2=ZONE ASSIGNMENT
  00 ** ** ** **
    
```

Edit Control Screen #3

Zone Assignment

A maximum of five zones can be programmed to each addressable control module. Pressing 2 while viewing Edit Control Screen #3 displays the following screen:

```

ZONE ASSIGNMENT
Z00 Z** Z** Z** Z**

```

Zone Assignment Screen

Note that Z** represents the Zone Number(s) corresponding to this device. The factory default for an unprogrammed device is Z00 for general alarm zone. A flashing cursor will appear on the first 0 to the left. Enter the two digit number corresponding to the zone that is to be assigned to this device. The cursor moves to the next Z** designation. Continue entering zone assignments or the remaining zones can be left blank or programmed as general alarm zones Z00. When all desired changes have been made, press the Enter key to store the zone assignments. The display will return to the Edit Control Screen #3.

```

EDIT CONTROL
1=ADJECTIVE/NOUN
2=DESCRIPTION

```

Edit Control Screen #4

Adjective/Noun

The Adjective/Noun selection allows the programmer to enter specific descriptors about the control module currently being programmed. Pressing 1 while viewing Edit Control Screen #4 will cause the following screen to be displayed:

```

1=STANDARD ADJECTIVE
2=STANDARD NOUN
3=CUSTOM ADJECTIVE
4=CUSTOM NOUN

```

Adjective/Noun Screen

1=STANDARD ADJECTIVE
2=STANDARD NOUN
3=CUSTOM ADJECTIVE
4=CUSTOM NOUN

Pressing 1 while viewing the Adjective/Noun Screen will cause the following screen(s) to be displayed. Note that the keyboard *down* arrow key must be pressed to see all the Adjective screens. Press the number corresponding to the adjective that is to be used as a descriptor for the location of the control module currently being programmed.

Adjective/Noun Screen

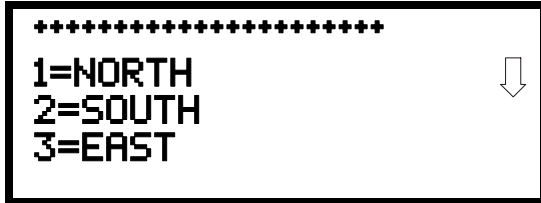

Adjective Screen #1



Adjective Screen #2



Adjective Screen #3

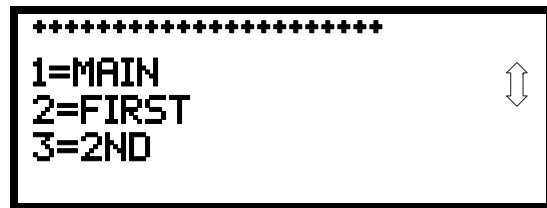

Adjective Screen #4

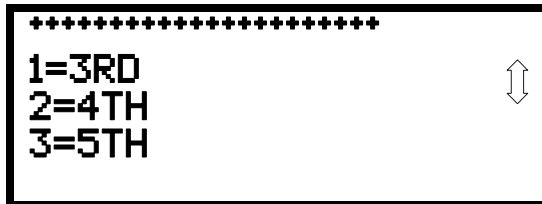

Adjective Screen #5

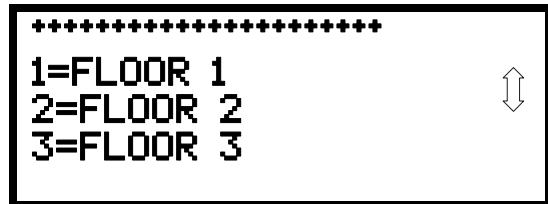

Adjective Screen #6

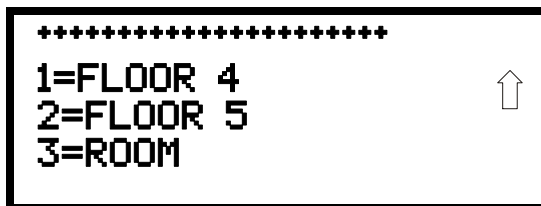

Adjective Screen #7

1=STANDARD ADJECTIVE
2=STANDARD NOUN
3=CUSTOM ADJECTIVE
4=CUSTOM NOUN

Pressing 2 while viewing the Adjective/Noun Screen will cause the following screen(s) to be displayed. Note that the keyboard *down* arrow key must be pressed to see all the Noun screens. Press the number corresponding to the noun that is to be used as a descriptor for the location of the control module currently being programmed.

Adjective/Noun Screen



Noun Screen #1



Noun Screen #2

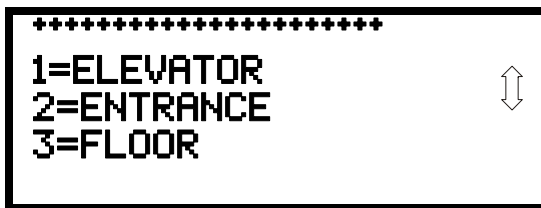

Noun Screen #3



Noun Screen #4



Noun Screen #5



Noun Screen #6



Noun Screen #7

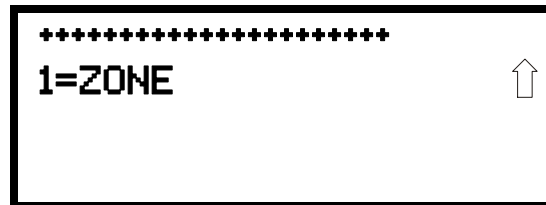

Noun Screen #8

Pressing 3 or 4 while viewing the Adjective/Noun Screen will display screens similar to the previous Adjective and Noun Screens. The new screens will list Custom Adjectives and Nouns which have been programmed into the control panel using the PK-CD programming kit. These descriptors are selected as described in the previous sections.

Description

The Description selection allows the programmer to enter additional information about the control module currently being programmed. This information will be displayed as part of the device label on the display. Pressing 2 while viewing Edit Control Screen #4 will cause the following screen to be displayed:



Edit Control Screen #4



Adjective/Noun Screen

A flashing cursor will appear at the first asterisk to the left. The programmer can enter additional descriptive information about the device being programmed. This information will appear on the display along with the standard device label information.

A maximum of 20 characters (including spaces) can be entered. To enter alphanumeric characters from the keypad, repeatedly press the appropriate key until the desired character is displayed in the first position. For example, to enter the letter *B*, press the 2 (*ABC*) key three times to toggle through the characters *I*, *A*, and *B*. Press the right arrow key to move the cursor one position to the right and repeat the process to enter the next character. To enter a space, press the * (*QZ*) key four times until a blank appears in the desired position. When all characters have been entered, press the Enter key to store the information. The display will return to the Edit Control Screen #4, displaying the new information at the bottom of the screen.

Recall/Increment Function

In addition, the user may use the Recall/Increment function at any time when the cursor is on the first letter of the Adjective or Noun field as follows:

- If the zero key is pressed, a 0 is placed in the first letter position.
- If the zero key is then pressed a second time with no intervening key actions, the entire Adjective field is replaced with the field entered *for the previous device programmed*, and the cursor moves to the last character of the field (Recall function). The Recalled Adjective or Noun field may now be changed letter-by-letter.
- If the zero key is pressed again with no other intervening key actions and the last character in the field is a number 0-9, the number is incremented by one (9 will change to 0). If the last character is a letter, it changes to a 0.
- The above increment function may be repeated with each press of the zero key.

As an example, the user could quickly enter 'FLR_3_ROOM 305' as follows:

1. The cursor is on the first letter of the Adjective field. Press the zero key twice to display *FLR_3*.
2. With the cursor on the first letter of the Noun field, press the zero key twice to recall the display *ROOM_304*. The cursor automatically jumps from the first to the last letter of the Noun field.
3. With the cursor on the last letter of the Noun field, press the zero key again to increment the room number to *305*.
4. Press the Enter key to store the information.

3.6.3 Zone Setup

Pressing 3 while viewing Programming Screen #2 will access the Zone Setup screens as illustrated below:

```

PROGRAMMING
1=AUTOPROGRAM
2=POINT PROGRAM
3=ZONE SETUP
    
```

Programming Screen #2

```

ZONE SETUP
1=ENABLE
2=DISABLE
3=ZONE 17 18 19
    
```

Zone Setup Screen #1

```

ZONE SETUP
1=ZONES INSTALLED
2=ZONES ENABLED
3=ZONES DISABLED
    
```

Zone Setup Screen #2

```

ZONE SETUP
1=ZONE TYPES
2=ZONES AVAILABLE
3=FUTURE USE
    
```

Zone Setup Screen #3

Enable

Pressing 1 for Enable, while viewing Zone Setup Screen #1, will display the following screen:

```

ZONE SETUP
1=ENABLE
2=DISABLE
3=ZONE 17 18 19
    
```

Zone Setup Screen #1

```

ZONE TO ENABLE
Z
    
```

Enable Screen

This screens allows the programmer to enable zones, one at a time. A flashing cursor appears next to the Z, prompting the programmer to enter a two digit zone number (01 - 19). When the second digit is entered, the zone will be enabled and the cursor returns to the original position next to the Z. Another zone can then be enabled.

Disable

Pressing 2 for Disable, while viewing Zone Setup Screen #1, displays the following:

```

ZONE SETUP
1=ENABLE
2=DISABLE
3=ZONE 17 18 19

```

Zone Setup Screen #1

```

ZONE TO DISABLE
Z █

```

Disable Screen

This screen allows the programmer to disable zones, one at a time. A flashing cursor appears next to the Z, prompting the programmer to enter a two digit zone number (01 - 19). When the second digit is entered, the zone will be disabled and the cursor will return to the original position next to the Z. Another zone can then be disabled.

Zone 17, 18, and 19

Pressing 3 for Zone 17, 18, and 19, while viewing Zone Setup Screen #1, will display the following screen:

```

SPEC PURPOSE ZONE
1=PAS 17      OFF
2=PRE-SIGNAL 18 OFF
3=TWO STAGE 19 OFF

```

Zone 17, 18, and 19 Screen

Zones 17, 18, and 19 can be programmed for normal zone operation or for special purpose applications. In the above illustration, the three zones are shown Off, which means they can be programmed to function in the same manner as all other zones, by assigning them to input and output devices in the Programming Zone Assignment Screen.

Pressing 1 will cause the display to change to *PAS 17 On*. Each press of the 1 key will cause the display to toggle between *PAS 17 On* and *PAS 17 Off*. When Zone 17 is programmed On, a PAS (Positive Alarm Sequence) activation of any smoke detector will cause Zone 17 to activate. By assigning Zone 17 to a control module in the Programming Zone Assignment Screen, an output device connected to the control module can be used to indicate a PAS condition in the control panel. *Do not assign Zone 17 to a Notification Appliance Circuit when using this zone to indicate a PAS condition. Attempting to do so will generate an error message and will be prevented by software checks.*

Pressing 2 will cause the display to change to *Pre-signal 18 On*. Each press of the 2 key will cause the display to toggle between *Pre-signal 18 On* and *Pre-signal 18 Off*. When Zone 18 is programmed On, a Pre-signal activation of any device will cause Zone 18 to activate. By assigning Zone 18 to a control module in the Programming Zone Assignment Screen, an output device connected to the control module can be used to indicate a Pre-signal condition in the control panel. *Do not assign Zone 18 to a Notification Appliance Circuit when using this zone to indicate a Pre-signal condition. Attempting to do so will generate an error message and will be prevented by software checks.*

Pressing 3 will cause the display to change to *Two Stage 19 On*. Each press of the 3 key will cause the display to toggle between *Two Stage 19 On* and *Two Stage 19 Off*. Refer to “Two Stage Operation” on page 101 for a description of this feature.

Zones Installed

Pressing 1 for Zones Installed, while viewing Zone Setup Screen #2, will display a screen similar to the following:

```
ZONE SETUP
1=ZONES INSTALLED
2=ZONES ENABLED
3=ZONES DISABLED
Zone Setup Screen #2
```

```
ZONES INSTALLED
00 01 02 03 04 05
```

Zones Installed Screen

This display will show all of the zones that have been programmed into the control panel.

Zones Enabled

Pressing 2 for Zones Enabled, while viewing Zone Setup Screen #2, will display a screen similar to the following:

```
ZONES ENABLED
00 01 02 04 05 06 07
08 09 10 11 12 13 14
15 16 17 18 19
```

Zones Enabled Screen

This display will show all of the zones that are enabled in the control panel.

Zones Disabled

Pressing 3 for Zones Disabled, while viewing Zone Setup Screen #2, will display a screen similar to the following:

```
ZONES DISABLED
03
```

Zones Disabled Screen

This display will show all of the zones that are disabled in the control panel.

ZONE SETUP
1=ZONE TYPES
2=ZONES AVAILABLE
3=FUTURE
 Zone Setup Screen #3

Zone Type

Zone Types must be programmed only if a DACT, programmed for zone reporting, is installed on the control panel. Pressing 1 for Zone Types, while viewing Zone Setup Screen #3, will display a screen similar to the following:

```

ZONE TYPE PROG
1=Z00 MONITOR
2=Z01 MONITOR
3=Z02 MONITOR
    
```

Zones Installed Screen

The Zones Installed screen will show the system zones (default and user programmed) and their associated types. Note that an up and/or down arrow will appear in the upper right corner of the display, indicating that additional screens of zone information exists. Press the up or down arrow keys to view zones Z00 through Z19.

Zone types can be changed by pressing the keypad number key corresponding to the zone in each Zones Installed Screen. Available zone types will be displayed in the resultant screens. For example, to change the zone type for zone Z02 in the screen illustrated above, press 3. The following screens will be displayed:

```

ZONE TYPE PROG
1=MONITOR
2=SMOKE PHOTO
3=WATERFLOW
    
```

Zone Type Program Screen #1

```

ZONE TYPE PROG
1=HEAT
2=PULL STATION
3=DUCT
    
```

Zone Type Program Screen #2

```

ZONE TYPE PROG
1=MEDICAL
2=HAZARD
3=TAMPER
    
```

Zone Type Program Screen #3

```

ZONE TYPE PROG
1=SUPERVISORY
2=PROC. MON
3=SMOKE ION
    
```

Zone Type Program Screen #4

```

ZONE TYPE PROG
1=NONE
    
```

Zone Type Program Screen #5

To change the zone type for Z02 to Pull Station, scroll the display until Zone Type Program Screen #2 is displayed. Press 2 to program zone Z02 as a Pull Station zone. The display will return to the Zones Installed Screen showing zone Z02 and the Pull Station program type. Repeat the procedure for each zone to be changed.

IMPORTANT! In Zone Type Program Screen #1, selecting WATERFLOW will assign a Waterflow silenceable zone type to the selected zone. Any signaling devices programmed to the same zone can be silenced by pressing the Alarm Silence key or by using the auto-silence feature.

To program a waterflow circuit as nonsilenceable, refer to “System Setup” on page 90 and “Water-flow Silenceable” on page 104.



NOTE: Zone Types are only relevant for Central Station reporting. Changing a zone type will only change how it is reported to the Central Station.



NOTE: If a tornado zone is required, choose Zone Type “Hazard”.

ZONE SETUP
1=ZONE TYPES
2=ZONES AVAILABLE
3=FUTURE

Zone Setup Screen #3

Zones Available

Pressing 2 while viewing Zone Setup Screen #3 will display the following screen:

```

ZONES AVAILABLE
01 02 03 04 05 06 07
08 09 10 11 12 13 14
15 16 17 18 19
  
```

The display will show all of the zones that are still available for programming.

3.6.4 Loop Setup

Loop Setup allows the programmer to configure the SLC Loop for NFPA Style 4, 6 or 7 wiring and to select the loop protocol. Pressing 1 while viewing Programming Screen #2 will cause the following screen to be displayed:

PROGRAMMING
1=LOOP SETUP
2=SYSTEM SETUP
3=VERIFY LOOP

Programming Screen #2

```

LOOP SETUP
1=STYLE           4
2=PROTOCOL       CLIP
  
```

Loop Setup Screen

Style

To program the SLC Style for the loop, press 1 for Style, while viewing Loop Setup Screen. In the preceding example, the control panel is programmed for Style 4 SLC wiring as indicated by the 4 to the right of Style in the display. To change the style, press 1 to toggle the display to read Style 6. Each press of the 1 key will cause the display to toggle between Style 4 and Style 6. *Note that, when programming the Loop Style, the programmer can only select between Style 4 and Style 6. To program a system for Style 7 wiring, the programmer must select the Loop Setup for Style 6. Style 7 wiring is the same as Style 6 with the added requirement that each device on the loop must have a pair of isolator modules, one on each side.* The factory default setting is Style 4.

Note on SLC Troubles: If the FACP reports an open fault on an SLC Loop programmed for Style 6, the trouble condition will latch at the FACP. When the SLC Loop has been repaired, the *Reset* button must be pressed at the FACP (at least 2 minutes after the trouble has been repaired) to clear the SLC trouble.

Loop Protocol

Loop Protocol refers to the SLC loop mode of operation. The only mode available is CLIP (Classic Loop Interface Protocol) which is used for the older legacy addressable devices such as the M300 Series modules and detectors as well as the newer devices. Pressing 2 while viewing the Loop Setup Screen will have no effect on programming.

Device Addressing

It is important to note that the MS-9050UD addressable device capacity is 50 detectors and control/monitor modules. Addressable devices must not be set to addresses higher than 50. Programming will not allow addresses higher than 50.

Important: Detectors and Modules cannot have the same address. For example, if a detector is installed at address 04, you cannot also have a module at address 04.

Note that It is permissible to mix old and new addressable devices on the same loop.

3.6.5 System Setup

System Setup allows the programmer to configure the following control panel features:

- *Trouble Reminder:* This feature, when enabled, provides an audible reminder that an alarm or trouble still exists on the FACP after the control panel has been silenced. The control panel piezo sounder will pulse once every 15 seconds during an alarm and every two minutes during a trouble condition, after the Alarm Silence or Acknowledge key is pressed. The piezo will continue to sound at these rates until the alarm or trouble condition is cleared. *Trouble Resound is independent of Trouble Reminder. If a silenced trouble condition is not cleared by midnight, the panel will reactivate the trouble sounder.*
- *Banner:* This option allows the user to change the top two lines of the LCD display from the factory default readout to a user defined readout when the control panel is in Normal condition.
- *Time-Date:* This feature allows the programmer to set the time, display format (24 hr or 12 hr), date and daylight savings time feature into the FACP memory
- *Timers:* This option allows the programmer to set the PAS (Positive Alarm Sequence) time delay, Pre-Signal time delay and Waterflow time delay.
- *NACs:* This feature allows the programmer to configure the control panel Notification Appliance Circuits for a variety of options, such as circuit type, silenceable/nonsilenceable, autosilence, coding, silence inhibit, zone assignment and enable/disable.
- *Relays:* This option allows programming of two onboard relays for activation by various control panel events, such as alarm, trouble, supervisory, etc.
- *Canadian Option:* This option allows the automatic programming of the FACP to Canadian specifications (refer to “Canadian Option” on page 104).
Important! *For Canadian Applications, this option must be set to ON prior to any other panel programming.*
- *Waterflow Silenceable:* This option provides the ability to silence any output circuit activated by a monitor module programmed as a waterflow type.

Pressing 2 for System Setup, while viewing Programming Screen #2, will cause the following screens to be displayed:

PROGRAMMING
 1=LOOP SETUP
 2=SYSTEM SETUP
 3=VERIFY LOOP

Programming Screen #2

↓

SYSTEM SETUP

1=TROUBLE REM OFF

2=BANNER

3=TIME-DATE

System Setup Screen #1

↑↓

SYSTEM SETUP

1=TIMERS

2=NAC

3=RELAYS

System Setup Screen #2

↑

SYSTEM SETUP

1=CANADIAN OPT. OFF

2=WATERFLOW SIL. NO

System Setup Screen #3

Trouble Reminder

The Trouble Reminder feature causes the control panel piezo to sound a reminder ‘beep’ for alarms and troubles, after the panel has been silenced. Refer to “*System Setup*” on page 90, for a detailed description of this feature. Pressing 1 while viewing System Setup Screen #1 will cause the display to toggle to *Trouble Rem On*, which enables this feature. Each press of the 1 key will cause the display to toggle between *Trouble Rem On* and *Trouble Rem Off*.

Banner

The top line of the display, which appears when the control panel is in normal mode, can be changed by using the Banner option. Pressing 2 while viewing System Setup Screen #1 will cause the following to be displayed:

BANNER

1=FACTORY

2=USER DEFINED

Banner Screen

```

BANNER
1=FACTORY
2=USER DEFINED

```

Banner Screen

Pressing *1* while viewing the Banner Screen will select the factory default banner setting and display the following screen:

```

FACTORY BANNER

```

Factory Banner Screen

The Factory Banner has now been selected and is stored in nonvolatile memory. Pressing the ESC key will return the display to the Banner Screen.

Pressing *2* while viewing the Banner Screen will cause the following screens to be displayed:

```

USER DEFINED BANNER
PRESS ENTER IF OK

```

User Defined Banner Screen #1

```

USER BANNER - LINE 2
PRESS ENTER IF OK
*****

```

User Defined Banner Screen #2

These screens allow the programmer to enter a two line custom banner. A flashing cursor will appear in the bottom left corner of each display. A maximum of 20 characters (including spaces) can be entered into each screen for a total of two lines with 40 characters. After entering up to 20 characters in the first screen, press *Enter* to view the second screen. Enter up to 20 characters in the second screen in the same manner or just press *Enter* if a second banner line is not being entered. To quickly clear the current banner, press the *CLR* key.

To enter alphanumeric characters from the keypad, repeatedly press the appropriate key until the desired character is displayed in the first position. For example, to enter the letter *B*, press the *2 (ABC)* key three times to toggle through the characters *I*, *A*, and *B*. Press the right arrow key to move the cursor one position to the right and repeat the process to enter the next character. To enter a space, press the **(QZ)* key four times to place a blank in the desired position. When all characters have been entered, press the *Enter* key to store the information. The display will return to the Banner Screen.

```

SYSTEM SETUP
1=TROUBLE REM
2=BANNER
3=TIME-DATE

```

System Setup Screen #1

Time-Date

The control panel time and date can be changed by pressing 3 while viewing the System Setup Screen #1. The following screen will be displayed:

```

TIME AND DATE
1=TIME 10:00 AM
2=DATE 01-21-2010
3=CLOCK FORMAT 12HR

```

Time-Date Screen #1

```

TIME AND DATE
1=DAYLIGHT SAVINGS

```

Time-Date Screen #2

■ Time

To change the time, press 1 while viewing the Time-Date Screen. The following screen will be displayed:

```

ENTER TIME
10:00 AM
1=AM          2=PM

```

Time Screen

A flashing cursor is located toward the top left of the display. Below the cursor is the current time. To change the time, enter the two-digit hours followed by the two-digit minutes. The cursor will move one position to the right each time a digit is entered. After the last minutes digit is entered, the cursor will again move one position to the right. At this point enter 1 for AM or 2 for PM. The display will then return to the Time-Date Screen which will show the new time entry. If an error is made while entering a digit, press the *CLR* key to delete the entire entry and begin again.

■ Date

To change the date, press 2 while viewing the Time-Date Screen. The following screen will be displayed:

```

ENTER DATE
MONTH DAY YEAR
01-21-2010

```

Date Screen

A flashing cursor is located toward the top left of the display. Below the cursor is the current date. To change the date, enter the two-digit month followed by the two-digit day and then the two-digit year (01 for 2001, 02 for 2002, etc.). The cursor will move one position to the right each time a

digit is entered. After the last year digit is entered, the display will return to the Time-Date Screen which will show the new date entry. If an error is made while entering a digit, press the *CLR* key to delete the entire entry and begin again.

■ **Clock Format**

The clock can be configured to display 12 hour (AM & PM) or 24 hour (military) time. Pressing 3 while viewing the Time-Date screen will cause the display to toggle between 12HR and 24HR. Select 12HR for 12 hour display or 24HR for 24 hour display.

*If the clock is changed to 24 hour (military) format, the date will change to the European standard of **Day-Month-Year** (for display purposes only).*

■ **Daylight Savings Time**

Pressing 1 while viewing Time-Date Screen #2 will cause the following screens to be displayed:



Time & Date Screen #2



Daylight Savings Screen #1



Daylight Savings Screen #2

Pressing 1 while viewing Daylight Savings Screen #1 will cause the display to toggle between *Enabled Yes* and *Enabled No*. The control panel will automatically update the time for daylight savings time when *Enabled Yes* is selected.

Pressing 2 while viewing Daylight Savings Screen #1 will display another screen which allows the programmer to select the month that daylight savings time will begin. In this sub-screen, pressing 1 will select March, 2 will select April, and 3 will select May.

Pressing 3 while viewing Daylight Savings Screen #1 will display two sub-screens which allow the programmer to select the week of the month that daylight savings time will begin. In the first sub-screen, pressing 1 will select the first week, 2 will select the second week, and 3 will select the third week, while in the second sub-screen, pressing 1 will select the fourth week and 2 will select the last week of the selected month.

Pressing 1 while viewing Daylight Savings Screen #2 will display another screen which allows the programmer to select the month that daylight savings time will end. In this sub-screen, pressing 1 will select September, 2 will select October, and 3 will select November.

Pressing 2 while viewing Daylight Savings Screen #2 will display two sub-screens which allow the programmer to select the week of the month that daylight savings time will end. In the first sub-screen, pressing 1 will select the first week, 2 will select the second week, and 3 will select the third week, while in the second sub-screen, pressing 4 will select the fourth week and 5 will select the last week of the selected month.

SYSTEM SETUP
1=TIMERS
2=NAC
3=RELAYS

System Setup Screen #2

Timers

Timer delays for PAS, Pre-signal and waterflow activation can be programmed by pressing *1* while viewing System Setup Screen #2. The following screen will be displayed:

TIMERS ↓
1=PAS DELAY 000
2=PRE SIGNAL 000
3=WATERFLOW 000

Timer Screen #1

TIMERS ↑
1=AC LOSS DELAY 000

Timer Screen #2

TIMERS
1=PAS DELAY 000
2=PRE SIGNAL 000
3=WATERFLOW 000

Timer Screen #1

■ **PAS (Positive Alarm Sequence) Delay**

The factory default setting for PAS is 000 for no delay. To select a PAS delay of 001 to 180 seconds for all devices programmed for PAS, press *1* while viewing Timer Screen #1. The following display will appear:

PAS DELAY
RANGE 0-180 SECONDS

█

PAS Delay Screen

A flashing cursor is positioned in the lower left corner of the display. Enter a delay time consisting of three digits, such as 005 for five seconds. Upon entering the third digit, the time delay will be stored in the control panel memory and the display will return to the Delay Screen which will indicate the new delay time.

■ Pre-signal Delay

The factory default setting for Pre-signal delay is 000 for no delay. To select a Pre-signal delay of 001 to 180 seconds for all devices programmed for Pre-signal, press 2 while viewing Timer Screen #1. The following screen will be displayed:



Pre-signal Delay Screen

A flashing cursor is positioned in the lower left corner of the display. Enter a delay time consisting of three digits, such as 009 for nine seconds. Upon entering the third digit, the time delay will be stored in the control panel memory and the display will return to the Delay Screen which will indicate the new delay time.

Note that detectors can be programmed for either PAS or Pre-signal operation, not both. Refer to "Edit Detector" on page 59 for programming details.

■ Waterflow Delay

A delay can be added prior to declaring a waterflow type of alarm. Be careful to include any built-in delays of the waterflow device. The factory default setting for Waterflow delay is 000 for no delay. To select a Waterflow delay of 01 to 90 seconds for all devices programmed for Waterflow delay, press 3 while viewing Timer Screen #1. The following screen will be displayed:

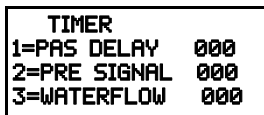

Timer Screen #1



Waterflow Delay Screen

A flashing cursor is positioned in the lower left corner of the display. Enter a delay time consisting of two digits, such as 25 for twenty-five seconds. Upon entering the second digit, the time delay will be stored in the control panel memory and the display will return to the Delay Screen which will indicate the new delay time.

■ AC Loss Delay

The reporting of a loss of AC power to a central station can be delayed by programming the length of the desired delay. The factory default setting is 2 hours. Press *1* while viewing Timer Screen #2 to display the following:

```
TIMER
1=AC LOSS DELAY
```

Timer Screen #2

```
AC LOSS DELAY
1=NO DELAY
2=ENTER DELAY
```

AC Loss Delay Screen #1

Pressing *1* while viewing AC Loss Delay Screen #1 will program the FACP to transmit an AC Loss report immediately to the central station.

Pressing *2* while viewing AC Loss Delay Screen #1 will display the following:

```
AC LOSS DELAY
RANGE 00-23
█
```

AC Loss Delay Screen #2

A flashing cursor will appear in the lower left corner of the display. The factory default setting is *02 hours*. Type the two digit AC loss reporting delay in hours (00 to 23 hour delay). When the second digit is entered, the display will return to AC Loss Delay Screen #1.



NOTE: Upon the loss of AC power at the control panel, relays programmed for 'AC Loss' will transfer immediately, regardless of the AC Loss Delay setting. If no troubles exist at the panel other than AC Loss, the System Trouble relay will delay its activation for the duration of the AC Loss Delay setting.

```
SYSTEM SETUP
1=TIMERS
2=NAC
3=RELAYS
```

System Setup Screen #2

NAC (Notification Appliance Circuit)

The options for the NACs on the control panel main circuit board can be configured by pressing *2* while viewing System Setup Screen #2. The following screens will be displayed:

```
NACS
1=NAC 1
2=NAC 2
```

NAC Selection Screen

The Notification Appliance Circuits can be configured independently by pressing *1* for NAC 1 or *2* for NAC 2.

The following screens will be displayed for each selection:

```

      NAC #
1=ENABLED      YES
2=TYPE         BELL
3=SILENCABLE  YES
  
```

NAC Screen #1

```

      NAC #
1=AUTO SILENCE 00
2=CODING
      STEADY
  
```

NAC Screen #2

```

      NAC #
1=ZONE
  00 ** ** ** **
2=SIL INHIBITED NO
  
```

NAC Screen #3

```

      NAC #
1=SYNC TYPE    S
  
```

NAC Screen #4

■ Enabled

Pressing *I* while viewing NAC Screen #1 will cause the display to change to *Enabled No*. This will prevent the selected main circuit board NAC from activating its devices. Each press of the *I* key will cause the display to toggle between *Enabled Yes* and *Enabled No*.

■ Type

The main circuit board NAC type can be programmed by pressing 2 while viewing NAC Screen #1. The following screen will be displayed. Press the down arrow key to view additional screens:



NAC Screen #1

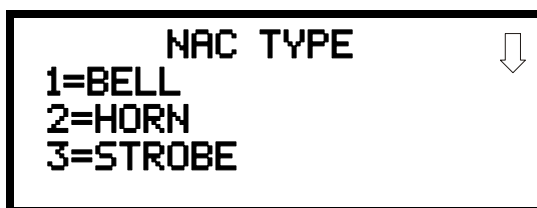

Type Screen #1

Select the NAC device type by pressing the number corresponding to the type in the appropriate screen. When the selection is made, the display will return to NAC Screen #1.

The following table contains NAC type codes and their functions:

NAC Type Code	Special Function
Bell	None
Horn	None
Strobe	None
Synced Strobe	Synchronized to manufacturer
Strobe Sil Sync	Same as Synced Strobe but Silence turns off audible & visual devices
Door Holder	NAC normally active ¹
Reset Power	NAC normally active ¹
Non-Reset Power	NAC normally active ¹

¹ **Important:** User should be aware that selecting Door Holder, Reset Power or Non-Reset Power types for an NAC will immediately activate (turn on) the NAC circuit and any devices connected to it, and therefore should not be used for notification appliances.

■ Silenceable

Pressing 3 while viewing NAC Screen #1 will cause the display to change to *Silenceable No*. This will prevent the selected main circuit board NAC from being silenced by pressing the Alarm Silence key or by the Auto Silence feature. Each press of the 3 key will cause the display to toggle between *Silenceable Yes* and *Silenceable No*.

Important: When a Notification Appliance Circuit with a mix of audible and visual devices is programmed for silenceable and the synchronization feature is selected, only the audible devices will be turned off if the Silence key is pressed or if the Autosilence feature is enabled. The visual devices (strobes, etc.) will continue to operate.

■ Auto Silence

The Auto Silence feature, when enabled, automatically silences all main circuit board silenceable notification appliances after a programmed length of time. To enable this feature and program the time delay before Auto Silence activation, press *1* while viewing NAC Screen #2. The following screens will be displayed:

NAC #
1=AUTO SILENCE
2=CODING
TEMPORAL

NAC Screen #2

↓

AUTO SILENCE
1=NO
2=5 MINUTES
3=10 MINUTES

Auto Silence Screen #1

↕

AUTO SILENCE
1=15 MINUTES
2=20 MINUTES
3=25 MINUTES

Auto Silence Screen #2

↑

AUTO SILENCE
1=30 MINUTES

Auto Silence Screen #3

To disable the Auto Silence feature, press *1* for *No* while viewing Auto Silence Screen #1. To enable the Auto Silence feature, press the number corresponding to the time delay which will elapse before Auto Silence activates. This information will be stored in memory and the display will return to NAC Screen #2.



NOTE: All silenceable control modules will be controlled by the Autosilence timer for NAC 1.

■ Coding (only for NACs not programmed as Sync Strobe Type)

The Coding feature allows the programmer to select the type of output that the main circuit board notification appliances will generate when activated. Pressing 2 while viewing NAC Screen #2 will cause the following displays to appear:



Coding Screen #1

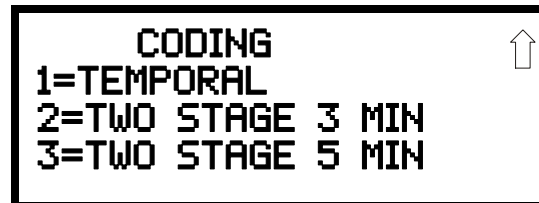

Coding Screen #2

The programmer can select the notification appliance output by pressing the number corresponding to the desired output. The coding selections are:

- Steady - a continuous output with no coding
- March Time - 120 ppm (pulse-per-minute) output
- California - 10 seconds on and 5 seconds off
- Temporal - ½ second on, ½ second off, ½ second on, ½ second off, ½ second on, 1½ second off
- Two Stage 3 Minutes or 5 Minutes - Refer to “Two Stage Operation” on page 101. for a description of this feature

Selection of one of the above options will cause the control panel to store the information in memory and return the display to NAC Screen #2, which will display the new coding choice.

Two Stage Operation

Two Stage operation consists of the following:

- 1st stage output - 20 ppm (pulse-per-minute) coding
- 2nd stage output - Temporal coding as described above
- Acknowledge button functions as the automatic alarm signal cancel button

If Two Stage operation is programmed as the Coding option, the following sequence of events will occur during an alarm.

1. The on-board NACs which are programmed to General Alarm Zone 0 will activate with a 1st stage output upon activation of any alarm point.
2. If the activated alarm point is directly mapped to a zone which is programmed to an on-board NAC, that NAC will go directly to 2nd stage coding output. All other NACs not directly mapped to the activated alarm point's zone but assigned to Zone 0 will activate with a 1st stage output.
3. If, after the programmed time of 3 or 5 minutes, the Acknowledge switch has not been pressed, all NACs presently in 1st stage activation will go to 2nd stage activation.
4. If an Acknowledge switch has been pressed, the Alarm LED will turn from flashing to steady. Any NACs currently in 1st stage activation will remain in 1st stage. Pressing the Acknowledge switch does not affect NACs already in 2nd stage activation.

5. If another alarm point is activated and the countdown timer is counting, the alarm point will have no effect on the NACs unless the alarm point's zones are directly mapped to one of the NACs, in which case it will follow the procedure outlined in step 2.
6. If another alarm point is activated and the countdown timer has stopped counting due to the Acknowledge switch being pressed, the countdown timer will restart and the NACs will respond as outlined in step 2. NACs already in 2nd stage activation will not be affected.
7. Any control modules assigned to special Zone 19 will be activated either by direct mapping of an input device programmed to Zone 19 or if an NAC enters 2nd stage operation.
8. Control modules that are programmed to the same zone as the activated input device will not be delayed for activation.

■ **Zone**

A maximum of five zones can be programmed to each main circuit board NAC. Pressing 1 while viewing NAC Screen #3 displays the following screen:

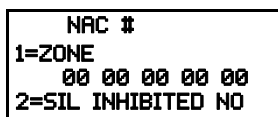

NAC Screen #3

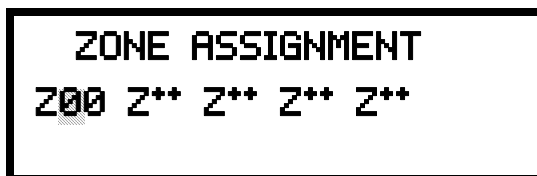

Zone Screen

Note that Z** represents the Zone Number(s) corresponding to the selected NAC. The factory default for an unprogrammed device is Z00 for general alarm zone. A flashing cursor will appear on the first 0 to the left. Enter the two digit number corresponding to the zone that is to be assigned to this NAC. The cursor moves to the next Z** designation. Continue entering zone assignments or the remaining zones can be left blank or programmed as general alarm zone Z00. When all desired changes have been made, press the Enter key to store the zone assignments. The display will return to the NAC Screen #3 which will show the zone assignments just entered.



NOTE: Zones do not apply to NACs programmed as Door Holder, Reser Power, or Non-Reset Power.

■ **Silence Inhibited**

The Silence Inhibit feature, when enabled, prevents the silencing of the selected main circuit board NAC for a period of one minute. Resetting the FACP will also be prevented for one minute while the NAC programmed for silence inhibit is activated. Pressing 2 while viewing NAC Screen #3 will cause the display to change from the factory default of *Silence Inhibit No to Silence Inhibit Yes*. Each press of the 2 key will cause the display to toggle between the two options.

■ **Sync Type**

If synchronized strobes were selected as the Type of device installed, the type of synchronization must be selected in this option. Pressing 1 while viewing NAC Screen #4 will cause the following screen to be displayed:

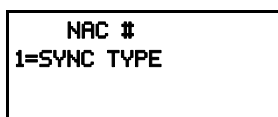

NAC Screen #4

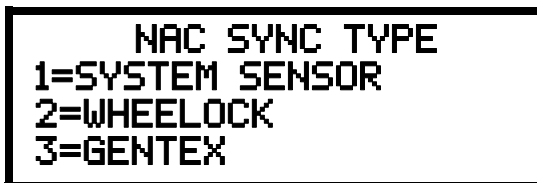

Pressing 1 while viewing this screen will select System Sensor synchronization, 2 will select Wheelock and 3 will select Gentex.

Maximum Number of Strokes for Synchronization

The total current draw for each Notification Appliance Circuit cannot exceed 2.5 amps. Refer to the manufacturer’s documentation supplied with the Strobes to determine the maximum current draw for each strobe and ensure that the circuit maximum is not exceeded.

To ensure proper strobe and circuit operation, there is also a limit to the number of strobes that can be attached to each circuit. Following is a list of the strobes that have been tested with this FACP and the maximum number that can be connected to each NAC. Make sure that the NAC maximum current is not exceeded:

- ✓ System Sensor: 40 Strobes
- ✓ Wheelock: 25 Strobes
- ✓ Gentex: 23 Strobes

Relays

Pressing 3 while viewing System Setup Screen #2 will allow the programmer to configure two main circuit board Form-C relays from the following screen:

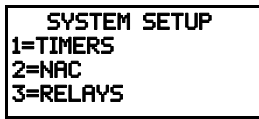

System Setup Screen #2

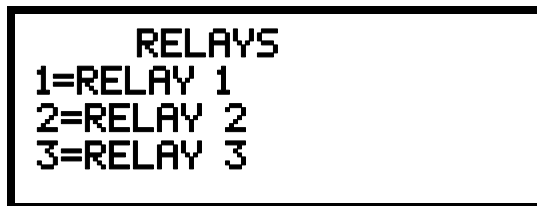

Relays Selection Screen

To program Relay 1 or Relay 3, press the number corresponding to the selected relay. Note that Relay 2 is fixed as a Trouble relay. Selecting Relay 2 will have no effect on its programming. The following screen will appear for each relay to be programmed:



Relay Type Screen

Pressing 1 for Type while viewing the Relay Screen will cause the following screens to be displayed:



Relay Screen #1

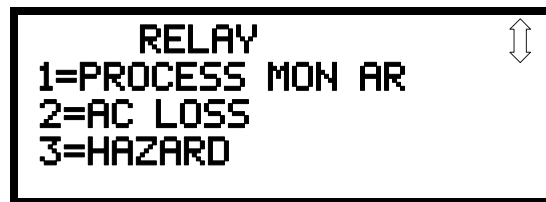

Relay Screen #3



Relay Screen #2



Relay Screen #4

While viewing the selected screen, press the number corresponding to the desired relay type to program the main circuit board relay. The choice will be stored in memory and the display will return to the Relay Type Screen which will show the programmed type choice. Press the Escape key to return to the Relays Selection Screen and repeat the preceding procedure for the remaining relays.

Notes:

1. *AR (AutoResettable)* in *SUPERVISORY AR* and *PROCMON AR* means that a relay with the Supervisory and/or Process Monitor type code, when activated, will automatically reset when the corresponding condition is cleared.
2. A relay programmed with the Silenceable Alarm type will activate upon any alarm and reset when the alarm is cleared and/or when the Alarm Silence button is pressed.

Canadian Option

Pressing *1* while viewing System Setup Screen #3 will configure the FACP to comply with Canadian requirements. The display will change to *Canadian Opt. On*. Each press of the *1* key will cause the display to toggle between *Canadian Opt. On* and *Canadian Opt. Off*. The factory default setting is *Canadian Opt. Off*.

```

SYSTEM SETUP
1=CANADIAN OPT. OFF
2=WATERFLOW SIL. NO

```

System Setup Screen #3

```

SYSTEM SETUP
1=CANADIAN OPT. OFF
2=WATERFLOW SIL. NO

```

Relays Selection Screen

For Canadian applications, remote annunciation must be done using the secondary ANN-BUS. The Canadian Options configures the FACP with the following as required by Canada:

- The following monitor module type codes are not available:
 - ✓ non-latching supervisory
 - ✓ non-latching process monitor
 - ✓ non-latching drill
 - ✓ process monitor
 - ✓ hazard
 - ✓ tornado
 - ✓ medical alert
- The auto-silence timer can only be set to 0 or 20 minutes.
- Addressable ionization smoke detector sensitivity is automatically monitored using Canadian specifications.
- Positive Alarm Sequence, the Pre-Signal option, and their corresponding timers are not available for Canadian applications.
- The installer must write in the Date of Final Assembly on the Master Marking and Warranty label located on the FACP backbox door.

Waterflow Silenceable

Pressing *2* while viewing System Setup Screen #3 will allow the programmer to configure the system for silenceable on nonsilenceable waterflow circuits. Each press of the *2* key will toggle the display between *Waterflow Sil. No* and *Yes*. When *Waterflow Sil. No* is selected, all output devices associated with a waterflow type input device, will be nonsilenceable. When *Waterflow Sil. Yes* is selected, all output devices associated with waterflow type input devices, will be silenceable. The factory default setting is *Waterflow Sil. No*.

3.6.6 Verify Loop

Pressing 3 while viewing Programming Screen #2, will select the Verify Loop option. During loop verification, the FACP polls each device on the SLC to determine if the device is communicating and whether or not it responds with the proper type identification. The following screen will be displayed while verification is in progress:

```

PROGRAMMING
1=LOOP SETUP
2=SYSTEM SETUP
3=VERIFY LOOP

```

Programming Screen #2

```

VERIFYING LOOPS
PLEASE WAIT

```

Verification Progress Screen

When Loop verification has been completed, the display will indicate that the system is OK or, if problems have been detected, any device type programming errors. Use the up and down arrow keys to view all detected errors.

3.6.7 History

The History option allows an authorized user to view or erase events which have occurred in the control panel. Pressing 1 while viewing Programming Screen #3 will display the History options as shown in the following display:

```

PROGRAMMING
1=HISTORY
2=WALKTEST
3=OPTION MODULES

```

Programming Screen #3

```

HISTORY
1=VIEW EVENTS
2=ERASE HISTORY

```

History Screen

View Events

Pressing 1 while viewing the History Screen will allow the user to select the events to be viewed as illustrated in the following:

```

HISTORY
1=VIEW EVENTS
2=ERASE HISTORY

```

History Screen

```

HISTORY
1=VIEW ALL
2=VIEW ALARMS
3=VIEW OTHER EVENTS

```

View Events Screen

While displaying the View Events screen, press 1 to view all events, 2 to view only alarms, or 3 to view other events. Use the up and down arrow keys to scroll through all of the displayed events.

Erase History

The Erase History option allows a user to erase all events from the history file. This will provide a clean slate in order to use the history file to track future events. Pressing 2 while viewing the History Screen will display the following screen:

```

ERASE HISTORY
PROCEED ?
1=YES          2=NO
  
```

Erase History Screen

Pressing 1 while viewing the Erase History Screen will erase all events from the History file. During this process, the display will read as follows:

```

ERASING HISTORY
PLEASE WAIT
  
```

Erase History Wait Screen

After the History file has been erased, the display will return to the History Screen.

3.6.8 Walktest

Walktest allows an individual to test the fire alarm system without the necessity to reset the control panel after each device activation. Pressing 2 while viewing the Programming Screen #3 will cause the following Walktest options to be displayed:

```

PROGRAMMING
1=HISTORY
2=WALKTEST
3=OPTION MODULES
  
```

Programming Screen #3

```

WALKTEST
1=SILENT
2=AUDIBLE
3=VIEW RESULT
  
```

Walktest Screen

To perform a silent walktest which will not sound the NACs, press 1 while viewing the Walktest Screen. To perform an audible walktest, which will sound the NACs, press 2 while viewing the Walktest Screen. When either option is chosen, the panel will enter Walktest Mode and the following screen will be displayed:

```

UNIT IN WALKTEST
1=VIEW WALKTEST LOG
2=VIEW POINTS
3=VIEW SUMMARY
  
```

Unit In Walktest Screen

From this screen, it is possible to view the walktest log, untested system points or a summary of the addressable devices tested during the current walktest. The user can select between any of these screens without interrupting the current walktest session. The walktest session will not end until the Unit In Walktest screen is exited by pressing the Escape key.

Pressing 1 for *View Walktest Log* while viewing the Unit In Walktest screen will cause a screen similar to one of the following two screens to be displayed:

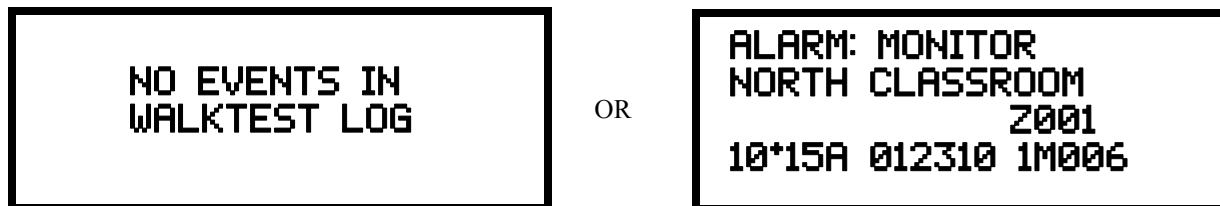

If there are no events in the current walktest session, the first screen will be displayed, indicating no events have been stored in the walktest log. If any events have been stored, a screen similar to the second will be displayed indicating the latest event. As walktest events occur, the display will change to indicate the latest event. All stored events can be scrolled on the screen by pressing the up or down arrow keys. To return to the first event, press the *1st Event* key.

Pressing 2 for *View Points* while viewing the Unit In Walktest screen will display a new screen which will show only the points that have not yet been walk tested. The up and down arrow keys will allow viewing of all untested points. If a point is tested while it is being displayed, the screen will update and display the next untested point. A description on the bottom of the screen will indicate if the displayed point has been disabled, if the Walktest option has been disabled for that point or if the point is not yet tested. The total number of untested points can be seen in the upper right corner of the screen.

Pressing 3 for *View Summary* while viewing the Unit In Walktest screen will display a new screen which will show a total of the tested detectors, tested modules, untested detectors and untested modules for the current walktest session.

The user can perform a one-person walktest by activating devices throughout the system. As each device is activated, the information about the activated device is store in the Walktest Log. The information can be viewed by choosing one of the options from the Unit In Walktest screen.

After completion of the Walktest, press the *Esc* (Escape) key to exit Walktest Mode and return to the Walktest Screen. The results of the Walktest can now be viewed by pressing 3 while viewing the Walktest Screen. The following screen will be displayed:



View Result Screen

Use the up and down arrow keys to view all of the walktest results which will be displayed as illustrated in the preceding screen. Note that the Walktest log is stored in RAM. If all power (AC and DC) is removed from the FACP, the Walktest log information will be lost. This information is also overwritten when subsequent walktests are performed.

3.6.9 Option Modules

Options available for the MS-9050UD include annunciators, printer connection for acquiring hard-copy printouts of panel data and onboard DACT.

Pressing 3 while viewing Programming Screen #3 will display the following screen:

```

PROGRAMMING
1=HISTORY
2=WALKTEST
3=OPTION MODULES
  
```

Programming Screen #3

```

OPTION MODULES
1=ANN-BUS
2=ONBOARD DACT
  
```

Options Screen

ANN-BUS

Pressing 1 while viewing the Option Modules screen will cause the control panel to display the following screens.

```

ANN-BUS
1=ENABLED NO
2=MODULES INSTALLED
3=AUTO-CONFIGURE
  
```

ANN-BUS Screen #1

```

ANN-BUS
1=ANN-S/PG OPTIONS
2=ANN-80 OPTIONS
3=ANN-SECONDARY
  
```

ANN-BUS Screen #2

A printer module and LCD annunciator module can be programmed into the MS-9050UD system. These devices communicate with the FACP over the ANN-BUS terminals on the control panel.

■ ANN-BUS Enabled

The ANN-BUS must be enabled if any modules are connected to the ANN-BUS terminals. To enable the ANN-BUS, press 1 while viewing ANN-BUS screen #1 so that the display reads *ANN-BUS Enabled Yes*. Each press of the 1 key will cause the display to toggle between *ANN-BUS Enabled Yes* and *ANN-BUS Enabled No*. The factory default setting is *ANN-BUS Enabled No*.

■ Modules Installed

If an ANN-BUS module is installed, press 2 while viewing ANN-BUS screen #1 to select ANN-BUS addresses for the module(s). The following screen will be displayed.

```

ANN-BUS MODULES ↓
1=ADDR. 1   NONE
2=ADDR. 2   NONE
3=ADDR. 3   NONE

```

ANN-BUS Modules Screen #1

Pressing the down arrow key will allow the programmer to view additional screens displaying Addresses 1-8. To select one or more addresses for the installed module(s), press the number key corresponding to the module address in each screen. The following screens will be displayed for each address:

```

ANN-BUS MODULE
ANN-BUS ADDRESS #
1=TYPE           NONE

```

Pressing 1 for *Type* will display the following screens:

```

ANN-BUS MODULE TYPE ↓
1=NOT INSTALLED
2=ANN-80 MODULE
3=ANN-I/O MODULE

```

Module Type Screen #1

```

ANN-BUS MODULE TYPE ↑
1=ANN-S/PG MODULE
2=ANN-LED MODULE
3=ANN-RLY MODULE

```

Module Type Screen #2

Press the number corresponding to the module type that is installed with the selected address.



NOTE: If the module type selected is the *ANN-80* or *ANN-S/PG* or if *Not Installed* is selected, the ANN-BUS Address Screen shown on the previous page will be displayed following the module selection. The options selected for each of these modules will be the same for all modules of the same type (refer to “ANN-S/PG (Print) Options Screen” on page 118 and “ANN-80 Options Screen” on page 119).

If *ANN-I/O*, *ANN-LED*, or *ANN-RLY* is the selected module type, the following ANN-BUS Address Screen will be displayed:

```

ANN-BUS MODULES
ANN-BUS ADDRESS #
1=TYPE          ANN-I/O
2=MODULE OPTIONS

```

ANN-BUS Address Screen

Since the options for each of these module types can be individually set, pressing *2* for *Module Options*, while viewing the ANN-BUS Address Screen will display the available options as described below.

ANN-I/O Options Screen

```

ANN-I/O ADDR #
1=POINT/ZONE  ZONE
2=RANGE      00-19
ACTIVE LEDS ONLY

```

ANN-I/O Address Screen

Pressing *1* while viewing the ANN-I/O Address Screen will program the annunciator module to annunciate either Point (addressable device address) information or Zone information. Each press of the *1* key will toggle the display between *Zone* and *Point*.

Pressing *2* while viewing the ANN-I/O Address Screen will select the Point range to be annunciated (refer to the tables in “ANN-I/O Zone Option” on page 111 and “ANN-I/O Point Option” on page 111). If Point has been selected, each press of the *2* key for *Range* will change the points to be annunciated with the options being 01 - 30 and 31 - 50.

Note that if Zone has been selected, the *2* key will have no effect since the only zones that can be annunciated are 00 - 19. The range cannot be changed.

ANN-I/O Zone Option

If *Zone* is selected as the module option, the first ten LED driver outputs on the ANN-I/O module will display the system status information. The remaining 20 LED driver outputs on the module will display the active/alarm status of each zone. The LED assignments for the ANN-I/O module will be as follows.

Module LED	Function
1	AC Fault
2	Fire Alarm
3	Supervisory
4	Trouble
5	Alarm Silenced
6	Not Used
7	Not Used
8	Not Used
9	Not Used
10	Not Used
11	Zone 00 - Active/Alarm
12	Zone 01 - Active/Alarm
13	Zone 02 - Active/Alarm
14	Zone 03 - Active/Alarm
15	Zone 04 - Active/Alarm
16	Zone 05 - Active/Alarm
17	Zone 06 - Active/Alarm
18	Zone 07 - Active/Alarm
19	Zone 08 - Active/Alarm
20	Zone 09 - Active/Alarm
21	Zone 10 - Active/Alarm
22	Zone 11 - Active/Alarm
23	Zone 12 - Active/Alarm
24	Zone 13 - Active/Alarm
25	Zone 14 - Active/Alarm
26	Zone 15 - Active/Alarm
27	Zone 16 - Active/Alarm
28	Zone 17 - Active/Alarm
29	Zone 18 - Active/Alarm
30	Zone 19 - Active/Alarm
31	Not Used
32	Not Used
33	Not Used
34	Not Used
35	Not Used
36	Not Used
37	Not Used
38	Not Used
39	Not Used
40	Not Used

ANN-I/O Point Option

If *Point* is selected as the module option, the first ten LED driver outputs on the first ANN-I/O module will display the system status information. The remaining 30 LED driver outputs on the first module and 20 LED driver outputs on the second module will be used to display the active/alarm status of each point in the Point Range programmed for that particular module. The

points that will be annunciated on a particular ANN-I/O module depend on the programming options selected as far as the device type (detector or module) to be annunciated. The LED assignments for each ANN-I/O module will be as follows.

Module LED	ANN-I/O Module #1 Function	ANN-I/O Module #2 Function
1	AC Fault	Not Used
2	Fire Alarm	Not Used
3	Supervisory	Not Used
4	Trouble	Not Used
5	Alarm Silenced	Not Used
6	Not Used	Not Used
7	Not Used	Not Used
8	Not Used	Not Used
9	Not Used	Not Used
10	Not Used	Not Used
11	Point 01 - Active/Alarm	Point 31 - Active/Alarm
12	Point 02 - Active/Alarm	Point 32 - Active/Alarm
13	Point 03 - Active/Alarm	Point 33 - Active/Alarm
14	Point 04 - Active/Alarm	Point 34 - Active/Alarm
15	Point 05 - Active/Alarm	Point 35 - Active/Alarm
16	Point 06 - Active/Alarm	Point 36 - Active/Alarm
17	Point 07 - Active/Alarm	Point 37 - Active/Alarm
18	Point 08 - Active/Alarm	Point 38 - Active/Alarm
19	Point 09 - Active/Alarm	Point 39 - Active/Alarm
20	Point 10 - Active/Alarm	Point 40 - Active/Alarm
21	Point 11 - Active/Alarm	Point 41 - Active/Alarm
22	Point 12 - Active/Alarm	Point 42 - Active/Alarm
23	Point 13 - Active/Alarm	Point 43 - Active/Alarm
24	Point 14 - Active/Alarm	Point 44 - Active/Alarm
25	Point 15 - Active/Alarm	Point 45 - Active/Alarm
26	Point 16 - Active/Alarm	Point 46 - Active/Alarm
27	Point 17 - Active/Alarm	Point 47 - Active/Alarm
28	Point 18 - Active/Alarm	Point 48 - Active/Alarm
29	Point 19 - Active/Alarm	Point 49 - Active/Alarm
30	Point 20 - Active/Alarm	Point 50 - Active/Alarm
31	Point 21 - Active/Alarm	Not Used
32	Point 22 - Active/Alarm	Not Used
33	Point 23 - Active/Alarm	Not Used
34	Point 24 - Active/Alarm	Not Used
35	Point 25 - Active/Alarm	Not Used
36	Point 26 - Active/Alarm	Not Used
37	Point 27 - Active/Alarm	Not Used
38	Point 28 - Active/Alarm	Not Used
39	Point 29 - Active/Alarm	Not Used
40	Point 30 - Active/Alarm	Not Used

ANN-LED Options Screen

Pressing 2 for Module Options while viewing ANN-BUS Address Screen when the ANN-LED option is selected, will display the following screen:

```

PROGRAMMING
1=ANN-RLY OPTIONS
2=ANN-LED OPTIONS
  
```

ANN-BUS Screen #3

```

ANN-LED ADDR #
ZONES 00-09
ALARM, TRBL, SUPV
  
```

ANN-LED Address Screen #1

```

ANN-LED ADDR #
1=POINT/ZONE    ZONE
2=ALARM/ATS     ATS
3=RANGE         ZN00-09
  
```

ANN-LED Address Screen #2

The first screen indicates that the ANN-LED at the selected ANN-BUS address is programmed to annunciate Alarms, Troubles and Supervisories for Zones 00 through 09. The programming can be changed using ANN-LED Address Screen 2.

Pressing 1 while viewing ANN-LED Address Screen #2 will program the annunciator module to annunciate either Point (addressable device address) information or Zone information. Each press of the 1 key will toggle the display between *Point* and *Zone*.

Pressing 2 while viewing ANN-LED Address Screen #2 will program the annunciator module to annunciate only Alarms or Alarms, Troubles and Supervisories (ATS). Each press of the 2 key will toggle the display between *Alarms* and *ATS*.

Pressing 3 while viewing ANN-LED Address Screen #2 will select the Point or Zone range to be annunciated (refer to the tables in “ANN-RLED Zone Option - Alarm Only” on page 114 and “ANN-RLED Point Option - Alarm Only” on page 115). Pressing the 3 key will display an additional screen where the range can be selected.

- If Zone has been selected, and Alarms Only are to be annunciated, the 3 key will have no effect since all zones can be displayed on only one ANN-LED module.
- If Zone has been selected, and Alarms, Troubles and Supervisories are to be annunciated, the new screen will give the options of annunciating Zone 0 - 9 or 10 - 19. Two ANN-LED modules are required to annunciate all zones in this configuration.
- If Points has been selected, and Alarms Only are to be annunciated, the new screen will give the options of annunciating Points 1 - 30 and 31 - 50. Two ANN-LED modules are required to annunciate all points in this configuration.
- If Point has been selected, and Alarms, Troubles and Supervisories are to be annunciated, the new screens will give the options of annunciating Points 1 - 10, 11 - 20, 21 - 30, 31 - 40 or 41 - 50. Five ANN-LED modules are required to annunciate all points in this configuration.

ANN-RLED Zone Option - Alarm Only

If *Zone* is selected as the module option, and the module is programmed to annunciate **alarms only**, the first ten LEDs on the ANN-RLED module will display the system status information. The next 20 LEDs on the module will display the active/alarm status of each zone. The last 10 LEDs are not used. The LED assignments for the ANN-RLED module will be as follows.

ANN-RLED Module				
Alarm Silenced	NAC 1 Fault	NAC 2 Fault	Not Used	Not Used
Earth Fault	Battery Fault	Charger Fault	Disabled	Maintenance
Zone 00 Active/Alarm	Zone 01 Active/Alarm	Zone 02 Active/Alarm	Zone 03 Active/Alarm	Zone 04 Active/Alarm
Zone 05 Active/Alarm	Zone 06 Active/Alarm	Zone 07 Active/Alarm	Zone 08 Active/Alarm	Zone 09 Active/Alarm
Zone 10 Active/Alarm	Zone 11 Active/Alarm	Zone 12 Active/Alarm	Zone 13 Active/Alarm	Zone 14 Active/Alarm
Zone 15 Active/Alarm	Zone 16 Active/Alarm	Zone 17 Active/Alarm	Zone 18 Active Alarm	Zone 19 Active/Alarm
Not Used	Not Used	Not Used	Not Used	Not Used
Not Used	Not Used	Not Used	Not Used	Not Used

ANN-LED Zone Option - Alarm, Trouble and Supervisory

If *Zone* is selected as the module option, and the module is programmed to annunciate **alarms, troubles, and supervisories**, the first ten LEDs on the first ANN-LED module will display the system status information. The remaining 30 LEDs on the first module and the last 30 LEDs on the second module will display the alarm, trouble and supervisory status for each of the ten zones in the Zone Range programmed for that particular module. The LED assignments for each ANN-LED module will be as follows.

First ANN-LED Module				
Alarm Silenced	NAC 1 Fault	NAC 2 Fault	Not Used	Not Used
Earth Fault	Battery Fault	Charger Fault	Disabled	Maintenance
Zone 00 Active/Alarm	Zone 01 Active/Alarm	Zone 02 Active/Alarm	Zone 03 Active/Alarm	Zone 04 Active/Alarm
Zone 00 Trouble	Zone 01 Trouble	Zone 02 Trouble	Zone 03 Trouble	Zone 04 Trouble
Zone 00 Supervisory	Zone 01 Supervisory	Zone 02 Supervisory	Zone 13 Supervisory	Zone 04 Supervisory
Zone 05 Active/Alarm	Zone 06 Active/Alarm	Zone 07 Active/Alarm	Zone 08 Active Alarm	Zone 09 Active/Alarm
Zone 05 Trouble	Zone 06 Trouble	Zone 07 Trouble	Zone 08 Trouble	Zone 09 Trouble
Zone 05 Supervisory	Zone 06 Supervisory	Zone 07 Supervisory	Zone 08 Supervisory	Zone 09 Supervisory

Second ANN-LED Module				
Not Used	Not Used	Not Used	Not Used	Not Used
Not Used	Not Used	Not Used	Not Used	Not Used
Zone 10 Active/Alarm	Zone 11 Active/Alarm	Zone 12 Active/Alarm	Zone 13 Active/Alarm	Zone 14 Active/Alarm
Zone 10 Trouble	Zone 11 Trouble	Zone 12 Trouble	Zone 13 Trouble	Zone 14 Trouble

Zone 10 Supervisory	Zone 11 Supervisory	Zone 12 Supervisory	Zone 13 Supervisory	Zone 14 Supervisory
Zone 15 Active/Alarm	Zone 16 Active/Alarm'	Zone 17 Active/Alarm	Zone 18 Active/Alarm	Zone 19 Active/Alarm
Zone 15 Trouble	Zone 16 Trouble	Zone 17 Trouble	Zone 18 Trouble	Zone 19 Trouble
Zone 15 Supervisory	Zone 16 Supervisory	Zone 17 Supervisory	Zone 18 Supervisory	Zone 19 Supervisory

ANN-RLED Point Option - Alarm Only

If *Point* is selected as the module option and the module is programmed to annunciate **alarms** only, the first ten LEDs on the first ANN-RLED module will display the system status information. The remaining 30 LEDs on the first module and LEDs 11 - 30 on the second module will display the active/alarm status of each point in the Point Range programmed for that particular module. The LED assignments for each ANN-RLED module will be as follows.

First ANN-RLED Module (Point Range 01 - 30)				
Alarm Silenced	NAC 1 Fault	NAC 2 Fault	Not Used	Not Used
Earth Fault	Battery Fault	Charger Fault	Disabled	Maintenance
Point 01 Active/Alarm	Point 02 Active/Alarm	Point 03 Active/Alarm	Point 04 Active/Alarm	Point 05 Active/Alarm
Point 06 Active/Alarm	Point 07 Active/Alarm	Point 08 Active/Alarm	Point 09 Active/Alarm	Point 10 Active/Alarm
Point 11 Active/Alarm	Point 12 Active/Alarm	Point 13 Active/Alarm	Point 14 Active/Alarm	Point 15 Active/Alarm
Point 16 Active/Alarm	Point 17 Active/Alarm	Point 18 Active/Alarm	Point 19 Active/Alarm	Point 20 Active/Alarm
Point 21 Active/Alarm	Point 22 Active/Alarm	Point 23 Active/Alarm	Point 24 Active/Alarm	Point 25 Active/Alarm
Point 26 Active/Alarm	Point 27 Active/Alarm	Point 28 Active/Alarm	Point 29 Active/Alarm	Point 30 Active/Alarm

Second ANN-RLED Module (Point Range 31 - 50)				
Not Used	Not Used	Not Used	Not Used	Not Used
Not Used	Not Used	Not Used	Not Used	Not Used
Point 31 Active/Alarm	Point 32 Active/Alarm	Point 33 Active/Alarm	Point 34 Active/Alarm	Point 35 Active/Alarm
Point 36 Active/Alarm	Point 37 Active/Alarm	Point 38 Active/Alarm	Point 39 Active/Alarm	Point 40 Active/Alarm
Point 41 Active/Alarm	Point 42 Active/Alarm	Point 43 Active/Alarm	Point 44 Active/Alarm	Point 45 Active/Alarm
Point 46 Active/Alarm	Point 47 Active/Alarm	Point 48 Active/Alarm	Point 49 Active/Alarm	Point 50 Active/Alarm
Not Used	Not Used	Not Used	Not Used	Not Used
Not Used	Not Used	Not Used	Not Used	Not Used

ANN-LED Point Option - Alarm, Trouble and Supervisory

If *Point* is selected as the module option, and the module is programmed to annunciate **alarms, troubles and supervisories**, the first ten LEDs on the first ANN-LED module will display the system status information. The remaining 30 LEDs on the first module and the last 30 LEDs on the

remaining modules will display the alarm, trouble and supervisory status for each of the ten points in the Point Range programmed for that particular module. The LED assignments for each ANN-LED module will be as follows.

First ANN-LED Module (Point Range 01 - 10)				
Alarm Silenced	NAC 1 Fault	NAC 2 Fault	Not Used	Not Used
Earth Fault	Battery Fault	Charger Fault	Disabled	Maintenance
Point 01 Active/Alarm	Point 02 Active/Alarm	Point 03 Active/Alarm	Point 04 Active/Alarm	Point 05 Active/Alarm
Point 01 Trouble	Point 02 Trouble	Point 03 Trouble	Point 04 Trouble	Point 05 Trouble
Point 01 Supervisory	Point 02 Supervisory	Point 03 Supervisory	Point 04 Supervisory	Point 05 Supervisory
Point 06 Active/Alarm	Point 07 Active/Alarm	Point 08 Active/Alarm	Point 09 Active/Alarm	Point 10 Active/Alarm
Point 06 Trouble	Point 07 Trouble	Point 08 Trouble	Point 09 Trouble	Point 10 Trouble
Point 06 Supervisory	Point 07 Supervisory	Point 08 Supervisory	Point 09 Supervisory	Point 10 Supervisory

Second ANN-LED Module (Point Range 11 - 20)				
Not Used	Not Used	Not Used	Not Used	Not Used
Not Used	Not Used	Not Used	Not Used	Not Used
Point 11 Active/Alarm	Point 12 Active/Alarm	Point 13 Active/Alarm	Point 14 Active/Alarm	Point 15 Active/Alarm
Point 11 Trouble	Point 12 Trouble	Point 13 Trouble	Point 14 Trouble	Point 15 Trouble
Point 11 Supervisory	Point 12 Supervisory	Point 13 Supervisory	Point 14 Supervisory	Point 15 Supervisory
Point 16 Active/Alarm	Point 17 Active/Alarm	Point 18 Active/Alarm	Point 19 Active/Alarm	Point 20 Active/Alarm
Point 16 Trouble	Point 17 Trouble	Point 18 Trouble	Point 19 Trouble	Point 20 Trouble
Point 16 Supervisory	Point 17 Supervisory	Point 18 Supervisory	Point 19 Supervisory	Point 20 Supervisory

The LED assignments for the modules annunciating Point Ranges 21 - 30, 31 - 40 and 41 - 50, will follow the same pattern as the second ANN-LED Module: third module Point Range 21 - 30, fourth module Point Range 31 - 40 and fifth module Point Range 41 - 50.

ANN-RLY Options Screen

Pressing 2 for *Module Options* while viewing ANN-BUS Address Screen when the ANN-RLY option is selected, will cause the following screen to be displayed:

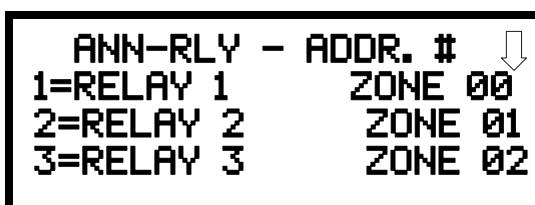

ANN-RLY Options Screen

The ANN-RLY module provides ten Form-C relays which can be programmed for various functions. The initial screen displays Relays 1 through 3. Pressing the down arrow key will display the remaining relays for this module.

To program any of the ANN-RLY relays, while viewing the appropriate ANN-RLY Option screen, press the number key corresponding to the relay to be programmed. Following is a list of the available programming options for each relay:

- Alarm
- Supervisory
- Supervisory AR
- Trouble
- Comm Fail
- Process Mon
- Process Mon AR
- AC Loss
- Hazard
- Medical
- Silenceable Alarm
- Zone Active XX (where XX = programmed zone 00 to 19)

■ Auto-Configure

The ANN-BUS Auto-Configure feature allows the programmer to quickly bring all installed ANN-BUS modules online. The software will search for all ANN-BUS modules and automatically program the device type and address into the system. *The ANN-BUS must be enabled for the Auto-Configure feature to work.* Pressing 3 while viewing ANN-BUS Screen #1 will begin the Auto-Configure process and cause the following screen to be displayed:



Auto-Configure Screen

■ ANN-S/PG (Print) Options Screen

The Print option allows the programmer to configure the optional printer. Pressing *1* while viewing ANN-BUS screen #2 will display the following screens:

```

ANN-S/PG OPTIONS
1=PORT          PAR
2=PRINTER SUPV NO
3=OFFLINE TIMER 60
  
```

ANN-S/PG Options Screen #1

```

ANN-S/PG OPTIONS
1=BAUD RATE    N/A
2=DATA BITS    N/A
3=PARITY       N/A
  
```

ANN-S/PG Options Screen #2

```

ANN-S/PG OPTIONS
1=STOP BITS    N/A
  
```

ANN-S/PG Options Screen #3

Pressing *1* for Port while viewing ANN-S/PG Options screen #1 will allow the programmer to select between a Parallel and Serial Port for printer connection. Each press of the *1* key will cause the display to toggle between *Port PAR* (parallel) and *Port SER* (serial). It is important to note that the interface selected determines which options are available to the user.

If the Parallel Port option is selected, the user has the option to supervise the printer and select an offline timer for the supervision by pressing *2* for Printer Supervision while viewing Print Options screen #1. Each press of the *2* key will cause the display to toggle between *Printer Supv NO* for no supervision and *Printer Supv YES* for printer supervision. Note that this option is not selectable if the Serial Port option has been selected.

If the Parallel Port option is selected, the user has the ability to select an *Offline Timer* by pressing *3* while viewing Print Options screen #1. The resultant screen allows the programmer to program the *Offline Timer* for a delay of between 0 and 255 seconds before loss of printer supervision is reported as a trouble.

If the Serial Port option is selected, the *Printer Supv* and *Offline Timer* options will not be available. The Baud Rate, Data Bits, Parity and Stop Bits options are only available when the Serial Port option has been selected.

Pressing *1* for *Baud Rate* while viewing ANN-S/PG Options screen #2 will cause a screen to appear which allow the user to select a Baud Rate of 19200, 9600, or 2400.

Pressing *2* for *Data Bits* while viewing ANN-S/PG Options screen #2 will cause a screen to appear which allows the user to select 7 or 8 *Data Bits*.

Pressing *3* for *Parity* while viewing ANN-S/PG Options screen #2 will cause a screen to appear which allows the user to select between *No Parity*, *Even Parity*, or *Odd Parity*.

Pressing 1 for Stop Bits while viewing ANN-S/PG Options screen #3 will cause a screen to appear which allows the user to select between 1.0 or 2.0 Stop Bits.

■ ANN-80 Options Screen

Pressing 2 while viewing ANN-BUS screen #2 will display the following screen:

```
ANN-80 OPTIONS
1=PIEZO ENABLE
2=LOCK ENABLE
3=ACK BTN ENABLE
```

ANN-80 Options Screen #1

```
ANN-80 OPTIONS
1=SIL BTN ENABLE
2=RST BTN ENABLE
3=DRL BTN ENABLE
```

ANN-80 Options Screen #2

The *Piezo Enable* option allows the programmer to select whether the piezo sounder on any installed ANN-80 module will ever sound. Pressing 1 while viewing the ANN-80 Options Screen #1 causes the display to toggle between *Piezo Enable Yes* and *Piezo Enable No*.

The *Lock Enable* option allows the programmer to select whether or not any installed ANN-80 annunciator must be unlocked by its key before any annunciator key presses will function. Pressing 2 while viewing the ANN-80 Options Screen #1 causes the display to toggle between *Lock Enable Yes* (annunciator must be unlocked for keys to function) and *Lock Enable No* (lock position is ignored).

The Acknowledge Button Enable (*ACK BTN ENABLE*) option allows the programmer to select whether the Ack/Step button on any installed ANN-80 annunciator will function normally or always be ignored. Pressing 3 while viewing the ANN-80 Options Screen #1 causes the display to toggle between *Ack Btn Enable Yes* (Ack/Step button functions normally) and *Ack Btn Enable No* (Ack/Step button never functions).

The Silence Button Enable (*SIL BTN ENABLE*) option allows the programmer to select whether the Silence button on any installed ANN-80 annunciator will function normally or always be ignored. Pressing 1 while viewing the ANN-80 Options Screen #2 causes the display to toggle between *Sil Btn Enable Yes* (Silence button functions normally) and *Sil Btn Enable No* (Silence button never functions).

The Reset Button Enable (*RST BTN ENABLE*) option allows the programmer to select whether the Reset button on any installed ANN-80 annunciator will function normally or always be ignored. Pressing 2 while viewing the ANN-80 Options Screen #2 causes the display to toggle between *Rst Btn Enable Yes* (Reset button functions normally) and *Rst Btn Enable No* (Reset button never functions).

The Drill Button Enable (*DRL BTN ENABLE*) option allows the programmer to select whether the Drill button on any installed ANN-80 annunciator will function normally or always be ignored. Pressing 3 while viewing the ANN-80 Options Screen #2 causes the display to toggle between *Drl Btn Enable Yes* (Drill button functions normally) and *Drl Btn Enable No* (Drill button never functions).

■ ANN-SECONDARY Options Screen

Pressing 3 while viewing ANN-BUS screen #2 will display the following screen:

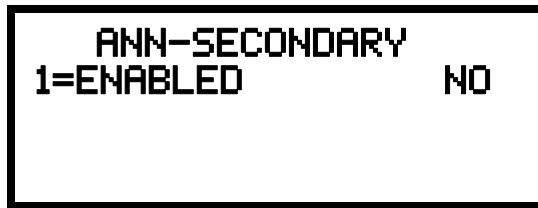

The ANN-SECONDARY must be enabled if any modules are connected to the ANN-SEC option card at J13. To enable the Secondary ANN-BUS, press 1 while viewing ANN-SECONDARY screen so that the display reads *ANN-SECONDARY Enabled Yes*. Each press of the 1 key will cause the display to toggle between *ANN-SECONDARY Enabled Yes* and *ANN-SECONDARY Enabled No*. The factory default setting is *ANN-SECONDARY Enabled No*.

Onboard DACT

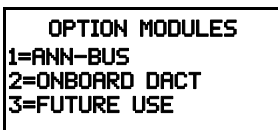

Option Module Screen

The Onboard DACT (Digital Alarm Communicator/Transmitter) provides communication to a central station. Pressing 2 while viewing the Option Module Screen will cause the following screens to be displayed:



On Board DACT Screen #1



On Board DACT Screen #2



On Board DACT Screen #3

■ Onboard DACT Enable

To enable the onboard DACT, press 1 while viewing Onboard DACT Screen #1 until the display reads *Enabled Yes*. The display will toggle between *Enabled Yes* and *Enabled No* with each press of the key. The factory default setting is *Enabled No*.

■ Primary Phone

Press 2 while viewing On Board DACT Screen #1 to program the type of primary phone line being connected to the DACT. The following screen will be displayed:

```

ON BOARD DACT
PRIMARY PHONE LINE
1=TYPE      TOUCHTONE
  
```

Primary Phone Line Screen

To select the type, press 1 while viewing the Primary Phone Line screen. The following screen will be displayed:

```

PHONE LINE
1=TOUCHTONE
2=ROTARY
  
```

Primary Phone Type Screen

Press 1 to select Touchtone dialing or 2 to select Rotary dialing.

■ Secondary Phone

```

ON BOARD DACT
1=ENABLED
2=PRIMARY PHONE
3=SECONDARY PHONE
  
```

On Board DACT Screen #1

Press 3 while viewing On Board DACT Screen #1 to program the type of secondary phone line being connected to the DACT. The following screen will be displayed:

```

ON BOARD DACT
SECONDARY PHONE LINE
1=TYPE      TOUCHTONE
  
```

Secondary Phone Line Screen

To select the type, press 1 while viewing the Secondary Phone Line screen. The following screen will be displayed:

```

PHONE LINE
1=TOUCHTONE
2=ROTARY
  
```

Secondary Phone Type Screen

Press 1 to select Touchtone dialing or 2 to select Rotary dialing.

Ring Count

ON BOARD DACT
1=RING COUNT
2=CENTRAL STATION
3=MANUAL DIAL MODE

The ring count designates the number of rings allowed on the phone line prior to answering an incoming call from a service terminal. The factory default is 0 which means the control panel will not answer any incoming calls. This entry may be programmed for 1 to 25 rings.

On Board DACT Screen #2 To change the Ring Count, press 1 while viewing the OnBoard DACT Screen #2. The following screen will be displayed:



Ring Count Screen

A flashing cursor will appear in the lower left corner of the display. Enter the two-digit ring count which can be a value between 00 and 25. After the second digit is entered, the display will return to the Service Terminal screen.

■ Central Station

Central Station programming configures the control panel DACT for contacting the central station. Pressing 2 while viewing On Board DACT Screen #2 will cause the following screens to be displayed:

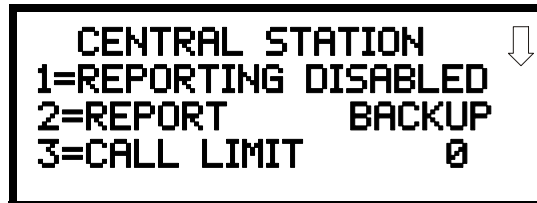

Central Station Screen #1



Central Station Screen #2

Note that the user will be prevented from entering the Central Station Options Screen while the DACT is busy calling the Central Station.

Reporting Enable

To enable the DACT for reporting FACP activity to the central station, press 1 while viewing Central Station Screen #1 so the display reads *Reporting Enabled*. Each press of the 1 key will toggle the display between *Reporting Disabled* and *Reporting Enabled*.

Backup Reporting

The DACT can be programmed to transmit reports to primary and/or secondary central station phone numbers as a backup. Press 2 while viewing Central Station Screen #1 to display the following screen:

```

  BACKUP REPORTING
  1=BACKUP ONLY
  2=BOTH
  3=FIRST AVAILABLE
  
```

Backup Reporting Screen

Press 1 to have all reports transmitted to the central station secondary phone number as a backup only if the primary phone line fails, 2 to transmit all reports to both the primary and secondary phone numbers all of the time, or 3 to send reports to the first available phone number.

■ Trouble Call Limit (Dialer Runaway Prevention)

The Call Limit option limits the number of DACT trouble calls to the Central Station, to a programmed amount between 0 and 99, for each unique trouble within a 24 hour period. All call limit counters reset (clear) at each midnight. Separate limit counters keep track of each unique type of trouble. Note that the number of phone number (communication) faults called to the Central Station are not limited by this feature. No subsequent restoral message is sent to the Central Station(s) for a particular trouble whose call limit has been reached. Local DACT annunciation will still track the particular trouble and restoral.

To set the Trouble Call Limit, press 3 while viewing Central Station Screen #1. The following screen will be displayed.

```

  TROUBLE CALL LIMIT
  00-99 RANGE
  +
  
```

Backup Reporting Screen

Enter a value between 00 and 99, then press Enter to set the Call Limit to this value.



NOTE: Entering a value of 00 will disable the Trouble Call Limit allowing the DACT to call the Central Station an unlimited number of times. This is the factory default setting.

Central Station Primary and Secondary Phone Numbers

CENTRAL STATION
1=PRIMARY
2=SECONDARY
3=REPORT STYLE

Central Station Screen #2

Pressing 1 for Primary or 2 for Secondary will display the following screens.

Note that the following information must be entered for both the Primary and Secondary Central Station Phone Numbers.

```

CENTRAL STATION #
1=TEST TIME INT 24
2=ACCOUNT CODE 0000
3=24HR TST TIME 0000
    
```

Primary/Secondary Screen #1

```

CENTRAL STATION
1=PHONE NUMBER
    
```

Primary/Secondary Screen #2

```

CENTRAL STATION
1=COMM FORMAT
ADEMCO-CONTACT-ID
    
```

Primary/Secondary Screen #3

```

CENTRAL STATION
1=EVENT CODES
    
```

Primary/Secondary Screen #4

```

CENTRAL STATION
1=TEST TIME INT
2=ACCOUNT CODE
3=24HR TST TIME

```

Primary/Secondary Screen #1

Test Time Interval

Pressing 1 while viewing Primary/Secondary Screen #1 will cause the following screens to be displayed:

```

TEST TIME INTERVAL ↓
1=24 HOURS
2=12 HOURS
3=8 HOURS

```

Test Time Interval Screen #1

```

TEST TIME INTERVAL ↑
1=6 HOURS

```

Test Time Interval Screen #2

The test report sent to the Central Station phone number may be sent once every 6, 8, 12, or 24 hours. Select the desired Test Time Interval by pressing the corresponding digit in the screens shown above.

Account Code

Pressing 2 while viewing Primary/Secondary Screen #1 will cause the following screen to be displayed:

```

ACCOUNT CODE
4 CHAR RANGE 0-F
█

```

Account Codes Screen

The Account Code, which is assigned by a Central Station, depends on the communication format being used. The Account Code screen will have a flashing cursor in the lower left corner. Enter the supplied account code using 0 - 9 and A - F keys. Enter the first digit, then press the right arrow key to move the cursor one position to the right. Repeat the process until all digits are entered. Press the right arrow key to store the Account Code in memory.

CENTRAL STATION
 1=TEST TIME INT
 2=ACCOUNT CODE
 3=24HR TST TIME

Primary/Secondary Screen #1

24 Hour Test Time

Pressing *3* while viewing Primary/Secondary Screen #1 will cause the following screen to be displayed:

24 HOUR TEST TIME
 RANGE 0000-2359
 █

24 Hour Test Time Screen

Use the 24 Hour Test Time screen to program the time that the DACT will transmit the 24 Hour Test to the Central Station. A flashing cursor will appear in the lower left corner of the screen. Enter a four digit number representing the test time using military time (0000 = midnight and 2359 = 11:59PM).

CENTRAL STATION
 1=PHONE NUMBER

Primary/Secondary Screen #2

Phone Number

Pressing *1* while viewing Primary/Secondary Screen #2 will cause the following screen to be displayed:

PHONE NUMBER
 20 NUMBERS MAXIMUM
 █

Phone Number Screen

The Phone Number screen is used to enter the Central Station phone number that the DACT will be contacting. A maximum of 20 characters can be entered with valid entries being 0 - 9 and A - F where A = *, B = #, C = look for secondary dial tone for up to 2 seconds (then dial anyway), D = 3 second pause, E = 5 second pause, and F = end of phone number (must be entered at end of phone number).

A flashing cursor will appear in the lower left corner of the screen. Enter the first digit then press the right arrow key to move the cursor to the right one position. Enter the second digit and repeat the process until all digits are entered. Press the *Enter* key to store the phone number in memory.

Enter the digits as you would like the number to be dialed. For example, if it's necessary to dial 9 before dialing a number outside the building, you may wish to pause after dialing 9. Enter 9 followed by *D* for a three second pause or *E* for a five second pause, then the phone number followed by an *F* to indicate the end of the number.

CENTRAL STATION
1=COMM FORMAT

Primary/Secondary Screen #3

Communication Format

Pressing *I* while viewing Primary/Secondary Screen #3 will cause the following screens to be displayed:

COMM FORMAT
1=ADEMCO EXPRESS 4P1
2=ADEMCO EXPRESS 4P2
3=3P1S C18 A23

Comm Format Screen #1

COMM FORMAT
1=3P1E C18 A23
2=3P1S C19 A14
3=3P1E C19 A14

Comm Format Screen #2

COMM FORMAT
1=4P1S C18 A23
2=4P1E C18 A23
3=4P1S C19 A14

Comm Format Screen #3

COMM FORMAT
1=4P1E C19 A14
2=4P2S C18 A23
3=4P2E C18 A23

Comm Format Screen #4

COMM FORMAT
1=4P2S C19 A14
2=4P2E C19 A14
3=ADEMCO CONTACT ID

Comm Format Screen #5

The Communication Format is determined by the type of receiver that the DACT is transmitting to. Consult your Central Station for proper selection or consult our factory representatives. For any format chosen, the control panel automatically programs all of the event codes.

Select the Communication Format by pressing the corresponding number key while viewing the appropriate Comm Format screen. The following table describes each format:

Screen Selection	Communication Format Description
ADEMCO EXPRESS 4P1	4+1 Ademco Express Standard, DTMF, 1400/2300 ACK
ADEMCO EXPRESS 4P2	4+2 Ademco Express Standard, DTMF, 1400/2300 ACK
3P1S C18 A23	3+1 Standard 1800 Hz Carrier, 2300 Hz ACK
3P1E C18 A23	3+1 Expanded 1800 Hz Carrier, 2300 Hz ACK
3P1S C19 A14	3+1 Standard 1900 Hz Carrier, 1400 Hz ACK
3P1E C19 A14	3+1 Expanded 1900 Hz Carrier, 1400 Hz ACK
4P1S C18 A23	4+1 Standard 1800 Hz Carrier, 2300 Hz ACK
4P1E C18 A23	4+1 Expanded 1800 Hz Carrier, 2300 Hz ACK
4P1S C19 A14	4+1 Standard 1900 Hz Carrier, 1400 Hz ACK
4P1E C19 A14	4+1 Expanded 1900 Hz Carrier, 1400 Hz ACK
4P2S C18 A23	4+2 Standard 1800 Hz Carrier, 2300 Hz ACK
4P2E C18 A23	4+2 Expanded 1800 Hz Carrier, 2300 Hz ACK
4P2S C19 A14	4+2 Standard 1900 Hz Carrier, 1400 Hz ACK
4P2E C19 A14	4+2 Expanded 1900 Hz Carrier, 1400 Hz ACK
ADEMCO CONTACT ID	Contact ID, DTMF, 1400/2300 ACK

Table 3.2 Communication Formats

Event Codes

Pressing *I* while viewing Primary/Secondary Screen #4 will cause the following screen to be displayed:

```
CENTRAL STATION
1=EVENT CODES
```

Primary/Secondary Screen #4

```
EVENT CODES
1=PULL STATION
2=MON-USER-DEF-1
3=WATERFLOW
```

Event Code Screen

Pressing the down arrow key allows viewing of all Events associated with the selected Communication Format. Pressing the number corresponding to the event displayed in each screen will display its default event code which can be customized by the programmer. For example, pressing *I* for Pull Station will display the following screen which allows the Event Code to be changed from the default value.

```
PULL STATION      115
```

Event Code Screen

The tables on the following pages list all of the Events and their default Event Codes for the various Communication Formats.

3+1, 4+1 Express, and 4+1 Standard

The information shown in Table 3.3 is automatically programmed for the Central Station phone number Event Codes when any of these Formats are selected. Enter 0 for an Event Code Setting to disable the report.

Event Description	Event Code Settings	
	Active	Restoral
PULL STATION	1	E
MON-USER-DEF-1	1	E
WATERFLOW	1	E
MON-USER-DEF-2	1	E
SMOKE (PHOTO)	1	E
DET-USER-DEF-1	1	E
SMOKE (ION)	1	E
DET-USER-DEF-2	1	E
HEAT DETECT	1	E
DET-USER-DEF-3	1	E
SMOKE DUCT-P	1	E
DET-USER-DEF-4	1	E
PHOTO W/HEAT	1	E
DET-USER-DEF-5	1	E
DUCT SUPERVISORY	8	E
DET-USER-DEF-6	8	E
PHOTO SUPERV	8	E
DET-USER-DEF-7	8	E
MONITOR	1	E
MON-USER-DEF-3	1	E
SMOKE CONVEN	1	E
MON-USER-DEF-5	1	E
HEAT CONVEN	1	E
MON-USER-DEF-6	1	E
MEDIC ALERT	0	0
MON-USER-DEF-7	0	0
HAZARD ALERT	0	0
MON-USER-DEF-8	0	0
TORNADO ALRT	0	0
MON-USER-DEF-9	0	0
TAMPER	8	E
MON-USER-DEF-11	8	E
MON SUPERVISORY	8	E
MON-USER-DEF-12	8	E
MON SUPERV AUTO	8	E
MON-USER-DEF-13	8	E
HVAC OVRRIIDE	8	E
POWER MON	6	A
MON-USER-DEF-14	6	A
TROUBLE MON	POINT_FAULT code will always be transmitted	
MON-USER-DEF-15	POINT_FAULT code will always be transmitted	
PROCESS MON	0	0
MON-USER-DEF-16	0	0
PROCMON AR	0	0
MON-USER-DEF-17	0	0

Table 3.3 Event Codes

POINT_FAULT	F	D
POINT_DISABLE	4	5
AC_FAIL	9	3
DRILL	B	C
SLC 1 OPEN FAULT	6	A
SLC 1 SHORT FAULT	6	A
GROUND FAULT	6	A
LOW BATTERY	6	A
NO_BATTERY	6	A
TELCO LINE 1	6	A
TELCO LINE 2	6	A
COMM FAULT 1	6	A
COMM FAULT 2	6	A
TOTAL COMM FLT ¹	0	0
PRINTER FAULT	6	A
NAC 1 FAULT	6	A
NAC 2 FAULT	6	A
27V SYS PWR FAULT	6	A
NAC 1 DISABLE	4	5
NAC 2 DISABLE	4	5
CS CALC FAULT	6	A
CHARGER FAULT	6	A
OPTION CARD 1 FAULT	6	A
ANN-BUS PWR FAULT	6	A
ZONE DISABLE	4	5
MODEM CHIP FAULT	6	A
ANN-BUS COMM FAULT	6	A
NO_DEVICES_INSTLLD	6	A
OFF_NORMAL_MESSAGE	6	A
24_HOUR_TEST	9	0
24 HOUR ABNORMAL TES	F	0
UPDOWN REQUEST	7	0
UPLOAD SUCCESS	7	0
DOWNLOAD SUCCESS	7	0
UPDOWN FAILURE	7	0
GENERAL_ALARM	0	0
GENERAL_SUPERVISORY	0	0

Table 3.3 Event Codes (Continued)

- 1 The FACP will not transmit a TOTAL COMM FAULT message to the Central Station upon communication restoral. This event code is used only for a local indication of a communication fault.

4+2 Standard, 4+2 Express, 3 + 1, 4 + 1, and 4+2 Expanded Formats

The information shown in Table 3.4 is automatically programmed for the Central Station phone number Event Codes when any of these Formats are selected. Enter 00 for an Event Code Setting to disable the report.

Event Description	Event Code Settings	
	Active	Restoral
PULL STATION	11	E1
MON-USER-DEF-1	11	E1
WATERFLOW	11	E1
MON-USER-DEF-2	11	E1
SMOKE (PHOTO)	11	E1
DET-USER-DEF-1	11	E1
SMOKE (ION)	11	E1
DET-USER-DEF-2	11	E1
HEAT DETECT	11	E1
DET-USER-DEF-3	11	E1
SMOKE DUCT-P	11	E1
DET-USER-DEF-4	11	E1
PHOTO W/HEAT	11	E1
DET-USER-DEF-5	11	E1
DUCT SUPERVISORY	81	E1
DET-USER-DEF-6	81	E1
PHOTO SUPERV	81	E1
DET-USER-DEF-7	81	E1
MONITOR	11	E1
MON-USER-DEF-3	11	E1
SMOKE CONVEN	11	E1
MON-USER-DEF-5	11	E1
HEAT CONVEN	11	E1
MON-USER-DEF-6	11	E1
MEDIC ALERT	00	00
MON-USER-DEF-7	00	00
HAZARD ALERT	00	00
MON-USER-DEF-8	00	00
TORNADO ALRT	00	00
MON-USER-DEF-9	00	00
TAMPER	81	E1
MON-USER-DEF-11	81	E1
MON SUPERVISORY	81	E1
MON-USER-DEF-12	81	E1
MON SUPERV AUTO	81	E1
MON-USER-DEF-13	81	E1
HVAC OVRIDE	81	E1
POWER MON	81	E1
MON-USER-DEF-14	81	E1
TROUBLE MON	POINT_FAULT code will always be transmitted	
MON-USER-DEF-15	POINT_FAULT code will always be transmitted	
PROCESS MON	00	00
MON-USER-DEF-16	00	00
PROC MON AR	00	00

Table 3.4 Event Codes

MON-USER-DEF-17	00	00
POINT_FAULT	F1	D1
POINT_DISABLE	41	51
AC_FAIL	92	93
DRILL	97	98
SLC 1 OPEN FAULT	43	53
SLC 1 SHORT FAULT	44	54
GROUND FAULT	61	A1
LOW BATTERY	62	A2
NO_BATTERY	63	A3
TELCO LINE 1	64	A4
TELCO LINE 2	65	A5
COMM FAULT 1	6A	AA
COMM FAULT 2	6B	AB
TOTAL COMM FLT ¹	00	00
PRINTER FAULT	6C	AC
NAC 1 FAULT	66	A6
NAC 2 FAULT	67	A7
27V SYS PWR FAULT	45	55
NAC 1 DISABLE	4B	5B
NAC 2 DISABLE	4C	5C
CS CALC FAULT	46	56
CHARGER FAULT	47	57
OPTION CARD 1 FAULT	48	58
ANN-BUS PWR FAULT	49	59
ZONE DISABLE	42	52
MODEM CHIP FAULT	49	59
ANN-BUS COMM FAULT	49	59
NO_DEVICES_INSTLLD	4A	5A
OFF_NORMAL_MESSAGE	6F	AF
24_HOUR_TEST	99	00
24 HOUR ABNORMAL TES	FB	00
UPDOWN REQUEST	71	00
UPLOAD SUCCESS	72	00
DOWNLOAD SUCCESS	73	00
UPDOWN FAILURE	74	00
GENERAL_ALARM	00	00
GENERAL_SUPERVISORY	00	00

Table 3.4 Event Codes (Continued)

- 1 The FACP will not transmit a TOTAL COMM FAULT message to the Central Station upon communication restoral. This event code is used only for a local indication of a communication fault.

Ademco Contact ID Format

The information shown in Table 3.5 is automatically programmed for the Central Station phone number Event Codes when Ademco Contact ID Format is selected. Enter *000* for an Event Code Setting to disable the report.

Event Description	Event Code Settings			4+2	
	Active	Zone	Point	Restoral	Active
PULL STATION	115	Zone	Point	E1	11
MON-USER-DEF-1	115	Zone	Point	E1	11
WATERFLOW	113	Zone	Point	E1	11
MON-USER-DEF-2	113	Zone	Point	E1	11
SMOKE (PHOTO)	111	Zone	Point	E1	11
DET-USER-DEF-1	111	Zone	Point	E1	11
SMOKE (ION)	111	Zone	Point	11	11
DET-USER-DEF-2	111	Zone	Point	11	11
HEAT DETECT	114	Zone	Point	11	11
DET-USER-DEF-3	114	Zone	Point	11	11
SMOKE DUCT-P	116	Zone	Point	11	11
DET-USER-DEF-4	116	Zone	Point	11	11
PHOTO W/HEAT	111	Zone	Point	11	11
DET-USER-DEF-5	111	Zone	Point	11	11
DUCT SUPERVISORY	200	Zone	Point	11	81
DET-USER-DEF-6	200	Zone	Point	11	11
PHOTO SUPERV	200	Zone	Point	11	81
DET-USER-DEF-7	200	Zone	Point	11	11
MONITOR	110	Zone	Point	11	11
MON-USER-DEF-3	110	Zone	Point	11	11
SMOKE CONVEN	111	Zone	Point	81	11
MON-USER-DEF-5	111	Zone	Point	11	11
HEAT CONVEN	114	Zone	Point	81	11
MON-USER-DEF-6	114	Zone	Point	11	11
MEDIC ALERT	100	Zone	Point	11	0
MON-USER-DEF-7	100	Zone	Point	11	0
HAZARD ALERT	150	Zone	Point	11	0
MON-USER-DEF-8	150	Zone	Point	11	0
TORNADO ALRT	150	Zone	Point	11	0
MON-USER-DEF-9	150	Zone	Point	11	0
TAMPER	144	Zone	Point	0	81
MON-USER-DEF-11	144	Zone	Point	0	81
MON SUPERVISORY	200	Zone	Point	0	81
MON-USER-DEF-12	200	Zone	Point	0	81
MON SUPERV AUTO	200	Zone	Point	0	81
MON-USER-DEF-13	200	Zone	Point	0	81
HVAC OVRRIIDE	200	Zone	Point	81	81
POWER MON	330	Zone	Point	81	81
MON-USER-DEF-14	330	Zone	Point	81	81
TROUBLE MON	POINT_FAULT code will always be transmitted			81	
MON-USER-DEF-15	POINT_FAULT code will always be transmitted			81	
PROCESS MON	000			81	0
MON-USER-DEF-16	000			81	0
PROCMON AR	000			81	0

Table 3.5 Event Codes

MON-USER-DEF-17	000			81	0
POINT_FAULT	380	Zone	Point		F1
POINT_DISABLE	570	Zone	Point		41
AC_FAIL	301	0	0	0	92
DRILL	604	0	0	0	97
SLC 1 OPEN FAULT	371	0	0	0	43
SLC 1 SHORT FAULT	372	0	0	0	44
GROUND FAULT	310	0	0	F1	61
LOW BATTERY	302	0	0	41	62
NO_BATTERY	311	0	0	92	63
TELCO LINE 1	351	0	0	97	64
TELCO LINE 2	352	0	0	43	65
COMM FAULT 1	354	1	1	44	6A
COMM FAULT 2	354	2	2	61	6B
TOTAL COMM FLT ¹	000	N/A	N/A	62	0
PRINTER FAULT	336	0	0	63	6C
NAC 1 FAULT	321	0	0	64	66
NAC 2 FAULT	322	0	0	65	67
27V SYS PWR FAULT	300	0	0	6A	45
not used	000	0	0	6B	49
NAC 1 DISABLE	521	0	0	0	4B
NAC 2 DISABLE	522	0	0	6C	4C
CS CALC FAULT	304	0	0	66	46
CHARGER FAULT	300	0	0	67	47
OPTION CARD 1 FAULT	331	0	0	45	48
ANN-BUS PWR FAULT	333	0	0	49	49
ZONE DISABLE	570	0	0	4B	42
MODEM CHIP FAULT	330	0	0	4C	49
ANN-BUS COMM FAULT	333	0	0	46	49
NO_DEVICES_INSTLLD	380	0	0	47	4A
OFF_NORMAL_MESSAGE	308	0	0	48	6F
24_HOUR_TEST	602	0	0	49	99
24 HOUR ABNORMAL TES	608	0	0	42	FB
UPDOWN REQUEST	411	0	0	49	71
UPLOAD SUCCESS	416	0	0	49	72
DOWNLOAD SUCCESS	412	0	0	4A	73
UPDOWN FAILURE	413	0	0	6F	74
GENERAL_ALARM	000	0	0	99	0
GENERAL_SUPERVISORY	000	0	0	FB	0

Table 3.5 Event Codes (Continued)

1 The FACP will not transmit a TOTAL COMM FAULT message to the Central Station upon communication restoral. This event code is used only for a local indication of a communication fault.

```

CENTRAL STATION
1=PRIMARY
2=SECONDARY
3=REPORT STYLE POINT

```

Central Station Screen #2

Report Style

Pressing 3 while viewing Central Station Screen #2 will cause the Report Style display to toggle between *Point* and *Zone*. Setting the Report Style to Point will program the DACT to report individual point status to the Central Station. The control panel is capable of monitoring a total of 50 addressable devices. Setting the Report Style to Zone will program the DACT to report zone status to the Central Station. The control panel is capable of monitoring a total of 20 individual zones.



NOTES:

1. Detector/Module Address 01 will be reported to the Central Station as Point 01,
2. Detector/Module Address 02 as Point 02, with reports continuing in a similar fashion up to Detector/Module Address 50 which will be reported as Point 50.

```

ON BOARD DACT
1=SERVICE TERMINAL
2=CENTRAL STATION
3=MANUAL DIAL MODE

```

On Board DACT Screen #2

■ Manual Dial Mode

Pressing 3 while viewing On Board DACT Screen #2 will cause the following screen to be displayed:

```

MANUAL DIAL MODE
1=PRIMARY PHONE
2=SECONDARY PHONE

```

Note that Manual Dial Mode cannot be entered while the panel is communicating with the Central Station. Pressing 1 for Primary Phone or 2 for Secondary Phone will display the following screen:

```

MANUAL DIAL MODE
1=GO OFF HOOK
2=DIAL DIGIT(S)
3=GO ON HOOK

```

Pressing 1 for Go Off Hook will cause the DACT to access the selected phone line (similar to taking the phone handset off the cradle). The selected phone line's red Active LED will turn on.

Pressing 2 for Dial Digit(s) will display a screen which allows the user to key in the phone number to be dialed. The first digit is keyed in and then the right arrow key is pressed to move the cursor to the next position. The next digit is keyed in and the process is repeated until all digits have been entered. Pressing the *Enter* key will cause the number just entered to be dialed.



NOTE: It is not necessary to go off-hook prior to dialing. Pressing the Enter key in Dial Digit mode will cause the panel to automatically go off-hook prior to dialing.

Pressing 3 for Go On Hook will cause the DACT to hang-up, deselecting the previously selected phone line. The phone line's red Active LED will turn off.

■ Phone Line Supervision

ON BOARD DACT
1=SUPERV PHONE LINE

On Board DACT Screen #3

Pressing *1* while viewing On Board DACT Screen #3 will cause the following screen to be displayed:

SUPERVISE PHONE LINE
1=PHONE LINE 2 YES

The *Phone Line 2* option allows the programmer to select whether the second phone line is supervised. Pressing *1* while viewing the On Board DACT Screen #3 causes the display to toggle between *Yes* and *No*. The factory default setting is *Yes*.

3.6.10 Password Change

PROGRAMMING
1=PASSWORD CHANGE
2=CLEAR PROGRAM
3=PROGRAM CHECK

Programming Screen #4

The factory set passwords, which have been programmed into the control panel, can be changed by selecting the Password Change option. Pressing *1* while viewing Programming Screen #4 will cause the following screen to be displayed:

PASSWORD CHANGE
1=MASTER
2=MAINTENANCE
3=REMOTE DOWNLOAD

Password Change Screen

Press *1* to change the Master Programming Level password, *2* to change the Maintenance Level password or *3* to change the Remote Download password. *Note that the passwords will not be displayed on annunciators.*

The following screen will appear when one of the change options is selected:

ENTER NEW FIVE DIGIT
PASSWORD

Enter Password Screen

A flashing cursor will appear in the center of the display. Enter a new five digit password (such as 10101 for the Master Level). After the fifth digit is entered, the following screen will be displayed:

VERIFY NEW
PASSWORD

Password Change Screen

The new five digit password must be re-entered to accept the change. The display will then return to the initial Password Change Screen.

3.6.11 Clear Program

PROGRAMMING
1=PASSWORD CHANGE
2=CLEAR PROGRAM
3=PROGRAM CHECK

Programming Screen #4

Pressing 2 while viewing Programming Screen #4, will select the Clear Program option. This will cause the LCD to display the following screen:

CLEAR PROGRAM
1=WHOLE SYSTEM
2=ALL POINTS

Clear Program Screen #1

Pressing 1, for Whole System while viewing the Clear Program Screen #1, will clear all general system programming options and all programmed addressable devices from the nonvolatile memory of the FACP. *This function is useful when the control panel is first installed, prior to autoprogramming. Note that it is necessary to autoprogram after using the Clear Whole System function.*

Pressing 2, for ALL POINTS while viewing the Clear Program Screen #1, will clear all programming related to the SLC loop and connected addressable devices.

Before executing any of the Clear commands listed above, the control panel will provide a warning to the user by prompting with the following display:

WARNING!
SYSTEM CHANGE
PROCEED?
1=YES **2=NO**

Pressing 1 will cause the control panel to carry out the selected clear option. Pressing 2 will prevent programming from being cleared.

3.6.12 Program Check

PROGRAMMING
1=PASSWORD CHANGE
2=CLEAR PROGRAM
3=PROGRAM CHECK

Programming Screen #4

The Program Check feature allows the programmer to view the zones which have been programmed to the Notification Appliance Circuits on the control panel but have not been programmed to Initiating Devices as well as other circuits with no input or output correlations. Pressing 3 while viewing Programming Screen #4 will cause the following screen to be displayed:

PROGRAM CHECK
1=NACS NO INPUT
2=ZONES NO INPUT
3=ZONES NO OUTPUT

PROGRAMCHECK
1=NACS NO INPUT
2=ZONES NO INPUT
3=ZONES NO OUTPUT

Program Check Screen

Pressing 1 while viewing the Program Check screen will display an NAC screen similar to the following.

NACS NO INPUT
NAC 1
05 10 12 15 17

The example above indicates that NAC 1 has been programmed to Zones 05, 10, 12, 15, and 17 but no input devices have been programmed to any of these zones. Use the up and down arrow keys to view all the NAC zones without input assignments for NAC 1 and NAC 2.

Pressing 2 while viewing the Program Check screen will display a screen similar to the following:

ZONES NO INPUT
05 07 09 10 11 1M001

The Zone No Input screen allows the programmer to view the zones which have not been programmed to at least one input device (not including general alarm Zone 00). The example in the preceding screen indicates that Zones 05, 07, 09, 10, and 11 have been programmed to an addressable module (control module in this example) with an address of 001 on loop 1 but have not been programmed to any input devices. Use the up and down arrow keys to view all the zones without input assignments.

Pressing 3 while viewing Program Check screen will cause a screen similar to the following to be displayed:

```
ZONES NO OUTPUT  
05 07 09 10 11 1D001
```

The Zone No Output feature allows the programmer to view the zones which have not been programmed to at least one output device (not including general alarm Zone 00). The example in the preceding screen indicates that Zones 05, 07, 09, 10, and 11 have been programmed to an addressable detector with an address of 001 on loop 1 but have not been programmed to any output devices. Use the up and down arrow keys to view all the zones without output assignments.

3.7 Maintenance Programming Level

To access Maintenance Programming mode, press the *Enter* key. The LCD will display the following:

```
1=READ STATUS  
2=PROGRAMMING  
3=MANUAL DIAL MODE  
4=REMOTE DOWNLOAD
```

To enter the Maintenance Programming mode, press 2. The display will read as follows:

```
PROGRAMMING  
ENTER PASSWORD
```

When the Maintenance level password (default *1111*) is entered, the following screen will appear:

```
PROGRAMMING  
1=POINT PROGRAM  
2=HISTORY  
3=PROGRAM CHECK
```



Note that in the preceding screens, an arrow appears to inform the programmer that additional options can be viewed by pressing the keypad *down* arrow key, as shown in the following screen.



3.7.1 Disable Point



Maintenance Screen #1

Pressing *1* for Point Program, while viewing Maintenance Screen #1 will cause the following screens to be displayed:



Device Select Screen

Select the device type by pressing *1* for an addressable detector or *2* for an addressable module. The operator will be prompted to enter the three digit device address as shown in the following example for a detector:



Address Select Screen

A flashing cursor will appear in the bottom left corner of the display, prompting for the three digit device address. When the third digit is enter, *001* for example, a screen will appear which will allow enabling or disabling of the selected point, as illustrated in the following example:



Enable/Disable Select Screen

Pressing *1* repeatedly will cause the display to toggle between *Enabled Yes* and *Enabled No*.

3.7.2 History

```

PROGRAMMING
1=POINT PROGRAM
2=HISTORY
3=PROGRAM CHECK

```

Maintenance Screen #1

Pressing 2 while viewing Maintenance Screen #1 will cause the following screen to be displayed:

```

HISTORY
1=VIEW EVENTS
2=ERASE HISTORY

```

History Screen

The History feature allows the operator to view control panel events which have been stored in a history file in memory and erase the contents of the history file

Pressing 1 while viewing the History screen will cause the following screen to be displayed:

```

HISTORY
1=VIEW ALL
2=VIEW ALARMS
3=VIEW OTHER EVENTS

```

Events Screen

To view all the events which have occurred in the control panel since the history file was last erased, press 1 while viewing the Events screen. To view only alarms which have occurred, press 2 while viewing the Events screen. To view events other than alarms, press 3. The most recent event will be displayed on the screen. To view all of the selected events, press the up or down arrow keys to scroll through the list of events. If no events have occurred, the display will read *NO EVENTS IN HISTORY*.

Pressing 2 while viewing the History Screen will cause the following screen to be displayed:

```

ERASE HISTORY
PROCEED ?
1=YES          2=NO

```

Erase History Screen

Pressing 1 while viewing the Erase History Screen will cause the message *ERASING HISTORY, PLEASE WAIT* to be displayed. The display will then return to the History Screen. Pressing 2 will cause the display to return to the History Screen without erasing the History file.

3.7.3 Program Check

```

PROGRAMMING
1=POINT PROGRAM
2=HISTORY
3=PROGRAM CHECK

```

Maintenance Screen #1

Pressing 3 while viewing Maintenance Screen #1 will cause the following screen to be displayed:

```

PROGRAM CHECK
1=NACS NO INPUT
2=ZONES NO INPUT
3=ZONE NO OUTPUT

```

Program Check Screen

The Program Check feature allows the programmer to view the zones which have been programmed to the Notification Appliance Circuits on the control panel but have not been programmed to Initiating Devices as well as other circuits with no input or output correlations. Pressing 1 while viewing Program Check screen will cause a screen similar to the following to be displayed.

```

NACS NO INPUT
NAC 1
05 10 12 15 17

```

The example above indicates that NAC 1 has been programmed to Zones 05, 10, 12, 15, and 17 but no input devices have been programmed to any of these zones. Use the up and down arrow keys to view all the NAC zones without input assignments for both NAC 1 and NAC 2.

Pressing 2 while viewing the Program Check screen will display a screen similar to the following:

```

ZONES NO INPUT
05 07 09 10 11 1M001

```

The Zone No Input screen allows the programmer to view the zones which have not been programmed to at least one input device (not including general alarm Zone 00). The example in the preceding screen indicates that Zones 05, 07, 09, 10, and 11 have been programmed to an addressable module (control module in this example) with an address of 001 on loop 1 but have not been programmed to any input devices. Use the up and down arrow keys to view all the zones without input assignments.

Pressing 3 while viewing Program Check screen will cause a screen similar to the following to be displayed:

```

      ZONES NO OUTPUT
    05 07 09 10 11 10001
  
```

The Zone No Output feature allows the programmer to view the zones which have not been programmed to at least one output device (not including general alarm Zone 00). The example in the preceding screen indicates that Zones 05, 07, 09, 10, and 11 have been programmed to an addressable detector with an address of 001 on loop 1 but have not been programmed to any output devices. Use the up and down arrow keys to view all the zones without output assignments.

3.7.4 Walktest

```

PROGRAMMING
1=WALKTEST
2=SYSTEM
3=ZONE SETUP
  
```

Maintenance Screen #2

To perform a walktest, press 1 while viewing Maintenance Screen #2. The following screen will be displayed:

```

      WALKTEST
    1=SILENT
    2=AUDIBLE
    3=VIEW RESULT
  
```

Walktest Screen

The operator can press 1 to perform a silent walktest or 2 to perform an audible walktest. Pressing 1 or 2 will cause the control panel to enter Walktest Mode and will display the following screen:

```

      UNIT IN WALKTEST
    1=VIEW WALKTEST LOG
    2=VIEW POINTS
    3=VIEW SUMMARY
  
```

Unit In Walktest Screen

From this screen, it is possible to view the walktest log, untested system points or a summary of the addressable devices tested during the current walktest. The user can select between any of these screens without interrupting the current walktest session. The walktest session will not end until the Unit In Walktest screen is exited by pressing the Escape key.

Pressing 1 for *View Walktest Log* while viewing the Unit In Walktest screen will cause a screen similar to one of the following two screens to be displayed:

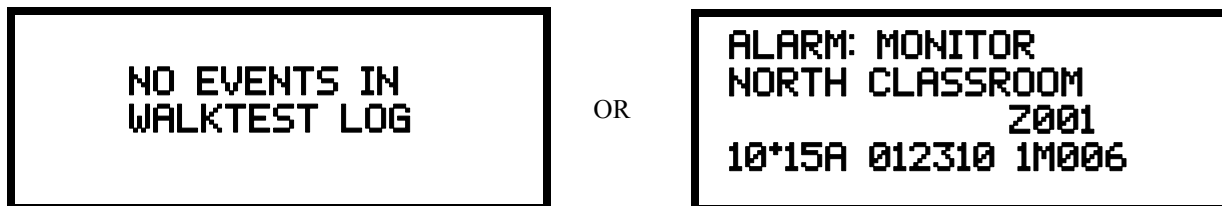

If there are no events in the current walktest session, the first screen will be displayed, indicating no events have been stored in the walktest log. If any events have been stored, a screen similar to the second will be displayed indicating the latest event. As walktest events occur, the display will change to indicate the latest event. All stored events can be scrolled on the screen by pressing the up or down arrow keys. To return to the first event, press the *1st Event* key.

Pressing 2 for *View Points* while viewing the Unit In Walktest screen will display a new screen which will show only the points that have not yet been walk tested. The up and down arrow keys will allow viewing of all untested points. If a point is tested while it is being displayed, the screen will update and display the next untested point. A description on the bottom of the screen will indicate if the displayed point has been disabled, if the Walktest option has been disabled for that point or if the point is not yet tested. The total number of untested points can be seen in the upper right corner of the screen.

Pressing 3 for *View Summary* while viewing the Unit In Walktest screen will display a new screen which will show a total of the tested detectors, tested modules, untested detectors and untested modules for the current walktest session.

To end the Walktest session, press the Escape key to return to the Walktest screen. Pressing 3 for *View Results* while viewing the Walktest screen, after a walktest session has been completed, will allow the operator to view the final results of the most recent walktest.

3.7.5 System

To program the time and date into the control panel, press 2 while viewing Maintenance Screen #2. The following display will appear:

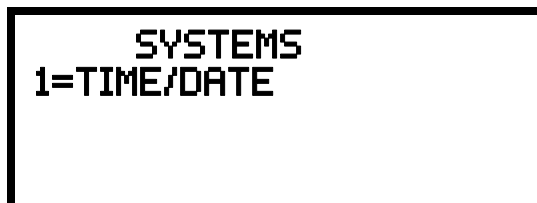

System Screen

Pressing 1 while viewing the System Screen will cause the following screen to be displayed:

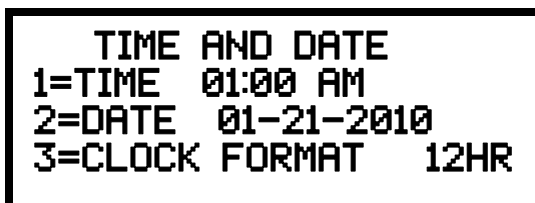

Time and Date Screen

To change the time, press 1 to display the following screen:



Time Screen

A flashing cursor will appear on the left side of the display. Enter the four digit number corresponding to the time (0000 - 1259). When the fourth digit is entered, the cursor will move one position to the right. Press 1 for AM or 2 for PM to complete entering the time. The display will return to the Time and Date Screen displaying the new time.

To change the date, press 2 while viewing the Time and Date Screen. The following screen will be displayed:



Date Screen

A flashing cursor will appear on the left side of the display. Enter the two digit month, two digit day and four digit year. The cursor will move one position to the right after each entry. When the fourth digit of the year has been entered, the display will return to the Time and Date Screen which will show the new date.

To change between 12 hour and 24 hour format, press 3 while viewing the Time and Date screen. Each press of the 3 key will toggle the display between 12 HR and 24 HR format.

3.7.6 Zone Setup



Maintenance Screen #2

Pressing 3 while viewing Maintenance Screen #2 will display the following screen:

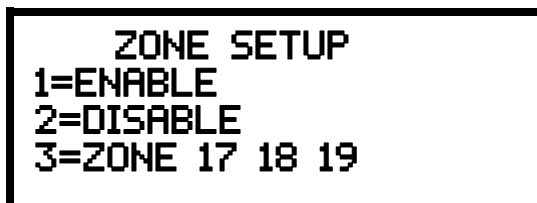

Zone Setup Screen

Pressing *1* while viewing Zone Setup screen will display the following screen:

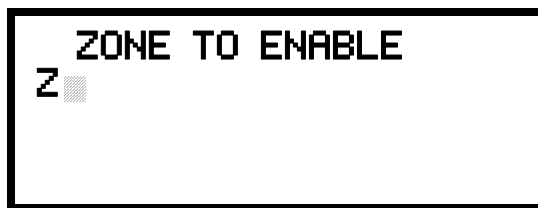

Enable Screen

A flashing cursor appears to the right of the Z. To enable a zone, enter the two digit zone number (00 - 19). After the second digit is entered, the zone will be enabled and the cursor will return to the original position. The next zone to be enabled can then be entered. Press *Esc* (Escape) to return to the previous screen.

Pressing *2* while viewing Zone Setup screen will display the following screen:



Disable Screen

A flashing cursor appears to the right of the Z. To disable a zone, enter the two digit zone number (00 - 19). After the second digit is entered, the zone will be disabled and the cursor will return to the original position. The next zone to be disabled can then be entered. Press *Esc* (Escape) to return to the previous screen.

Pressing *3* while viewing Zone Setup screen will display the following screen:

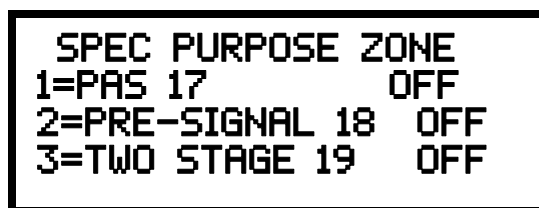

Disable Screen

Zones 17, 18, and 19 can be programmed for normal zone operation or for special purpose applications. In the above illustration, the three zones are shown Off, which means they can be programmed to function in the same manner as all other zones, by assigning them to input and output devices in the Programming Zone Assignment Screen.

Pressing *1* will cause the display to change to *PAS 17 On*. Each press of the *1* key will cause the display to toggle between *PAS 17 On* and *PAS 17 Off*. When Zone 17 is programmed On, a PAS (Positive Alarm Sequence) activation of any smoke detector will cause Zone 17 to activate. By assigning Zone 17 to a control module in the Programming Zone Assignment Screen, an output device connected to the control module can be used to indicate a PAS condition in the control panel. *Do not assign Zone 17 to a Notification Appliance Circuit when using this zone to indicate a PAS condition.*

Pressing 2 will cause the display to change to *Pre-signal 18 On*. Each press of the 2 key will cause the display to toggle between *Pre-signal 18 On* and *Pre-signal 18 Off*. When Zone 18 is programmed On, a Pre-signal activation of any device will cause Zone 18 to activate. By assigning Zone 18 to a control module in the Programming Zone Assignment Screen, an output device connected to the control module can be used to indicate a Pre-signal condition in the control panel. *Do not assign Zone 18 to a Notification Appliance Circuit when using this zone to indicate a Pre-signal condition.*

Pressing 3 will cause the display to change to *Two Stage 19 On*. Each press of the 3 key will cause the display to toggle between *Two Stage 19 On* and *Two Stage 19 Off*. Refer to “Two Stage Operation” on page 101 for a description of this feature.

Section 4: Operating Instructions

4.1 Panel Control Buttons

4.1.1 Acknowledge/Step

The first press of the *Acknowledge/Step* button silences the piezo sounder, changes flashing indicators/LEDs to steady and also changes the status field on the LCD display from capital letters to small letters. When the piezo is silenced, an *acknowledge* message is sent to the printer and the history file. *Acknowledge* also sends a *silence piezo* command to the optional annunciators connected to the FACP.

When more than one event exists, the first press of the Acknowledge/Step button functions as described in the preceding paragraph. Subsequent pressing of the button *steps* through each off-normal active event, with alarm events having a higher priority than trouble and supervisory events.

4.1.2 Alarm Silence

The *Alarm Silence* button performs the same functions as Acknowledge/Step. In addition, if an alarm exists, it turns off all silenceable NACs (Notification Appliance Circuits) and causes Alarm Silenced indicator to turn on. It also sends an 'alarm silenced' message to the printer, history file and optional annunciators. A subsequent new alarm will resound the system NACs. *Note that the Alarm Silenced indicator is turned off by pressing the Reset button, the Drill button or subsequent activation of the NACs.*

4.1.3 Drill/Hold 2 Sec

When the *Drill* button is held for a minimum of two seconds (time required to prevent accidental activations), the FACP turns on both main panel NAC outputs and all silenceable circuits such as control modules that are programmed as silenceable, and turns off the Alarm Silenced indicator if it was previously on. The *EVAC IN SYSTEM* message is shown on the LCD display. The same message is sent to the printer and history file. The *Alarm Silence* button can be used to turn off all silenceable NAC outputs following activation by the *Drill* button.

4.1.4 Reset

Pressing and releasing the *Reset* button turns off all control modules and NACs, temporarily turns off resettable power to 4-wire detectors, causes a *RESET IN SYSTEM* message to be displayed on the LCD and sends the same message to the printer and history file. It also performs a lamp test by turning on all indicators/LEDs (except the Ground LED), piezo sounder and LCD display segments after the *Reset* button is released. Any alarm or trouble that exists after a reset will resound the system.

4.2 Status Indicators and LEDs

The five status indicators which are located on the front panel and the three LEDs located on the main circuit board, operate as follows:

AC Power

AC Power indicator illuminates green if AC power is applied to the FACP. A loss of AC power will turn off this indicator.

Fire Alarm

Fire Alarm indicator flashes red when one or more alarms occur. It illuminates steady when the *Acknowledge/Step* or *Alarm Silence* button is pressed. The *Fire Alarm* indicator turns off when the *Reset* button is pressed. The indicator will remain off if all alarms have been cleared.

Supervisory

Supervisory indicator flashes yellow when one or more supervisory conditions occur, such as a sprinkler valve tamper condition. It illuminates steady when the *Acknowledge/Step* or *Alarm Silence* button is pressed. It turns off when the *Reset* button is pressed and remains off if all supervisory alarms have been cleared.

Trouble

Trouble indicator flashes yellow when one or more trouble conditions occur. It stays on steady when the *Acknowledge/Step* or *Alarm Silence* button is pressed. The indicator turns off when all trouble conditions are cleared. This indicator will also illuminate if the microprocessor watchdog circuit is activated.

Alarm Silenced

Alarm Silenced indicator illuminates yellow after the *Alarm Silence* button is pressed while an alarm condition exists. It turns off when the *Drill* or *Reset* button is pressed.

Primary Line Active

This is a red LED, located on the main circuit board, that indicates the primary phone line is active.

Secondary Line Active

This is a red LED, located on the main circuit board, that indicates the secondary phone line is active.

Kiss-off

This is a green LED, located on the main circuit board, that blinks when a Central Station has acknowledged receipt of each transmitted message or when a portion of upload or download data has been accepted from a Service Terminal.

4.3 Normal Operation

With no alarms or troubles in the system, the display message is *System All Normal* along with the current time and date as shown below. To set the time and date, refer to the appropriate section in this manual.



The MS-9050UD performs the following functions at regular intervals while in Normal mode:

- ✓ Monitors AC input voltage and battery voltage
- ✓ Monitors and reports status of SLC loop, option cards and control panel
- ✓ Polls all devices on the SLC loop and flashes each device LED while checking for valid replies, alarms, troubles, etc.
- ✓ Refreshes LCD display and updates time
- ✓ Scans control panel keypad for key presses

- ✓ Performs autotest for all SLC devices
- ✓ Tests memory
- ✓ Updates and reads all communications busses (EIA-485, EIA-232, etc.)

4.4 Trouble Operation

With no alarms in the system, the detection of a trouble will cause the following:

- The piezo to pulse 1 second On and 1 second Off
- The system Trouble LED to flash one second On and one second Off
- The trouble relay to activate
- *TROUBL* with device type, noun/adjective, address and trouble description will appear on the LCD display
- The same message, along with the time and date, is sent to the optional printer and the history buffer.
- Communicate the trouble conditions to the Central Station
- Terminate upload or download communications

Note that specific troubles will initiate additional actions; for example, loss of AC power will turn off the AC Power LED, etc.

Addressable Smoke Detectors, Monitor Modules and Control Modules

For addressable devices connected to the SLC loop, the following is a typical message that could appear on the LCD display for a device trouble:

```

TROUBL SMOKE (PHOTO)
<ADJ> <NOUN>
      INVREP
10:00A 012110 10001
```

The information displayed in the above example provides the following information:

- First line in display:
 - The type of event; in this example *TROUBL* indicating a device trouble
 - Device type identifier; in this example, *SMOKE (PHOTO)* indicates a Photoelectric smoke detector. Other device type identifiers which can be displayed include *SMOKE (ION)* for Ionization Detector, *HEAT* for Heat Detector, *CONTROL* for Control Module, and *MONITOR* for Monitor Module, *PULL STATION* for a manual pull box, etc. Refer to “*Edit Detector*” on page 59, “*Edit Module Screen for Monitor Module*” on page 69, and “*Edit Module Screen for Control Modules*” on page 78 for information on additional device types.
- Second line in display:
 - <ADJ>; refers to the user programmed adjective descriptor from library list resident in the control panel or custom entry via PC.
 - <NOUN>; refers to the user programmed noun descriptor from library list resident in the control panel or custom entry via PC.
- Third line in display: *INVREP* indicates an invalid reply from the addressable device. Other possible troubles include:
 - ✓ *SHORT* - indicating a shorted circuit on an addressable device
 - ✓ *OPEN* - indicating an open circuit on an addressable device
 - ✓ *DIRTY1* - maintenance alert indicating that a detector is near but below the allowed alarm limit and is in need of maintenance before the performance is compromised

- ✓ *DIRTY2* - maintenance alert indicating that a detector needs immediate maintenance since it has been within 80% of its alarm threshold for 24 hours
- ✓ *INVREP* - maintenance alert indicating a hardware problem in the detector
- ✓ *TEST F* - indicating a detector has failed the automatic test operation which functionally checks its sensing chamber and electronics
- ✓ *INV ID* - indicating that an incorrect device code (Type ID) has been programmed for an installed device (for example, Photo has been programmed but an Ion detector has been installed)
- ✓ *SW TBL* - indicating a module has failed the testing of its Class A switching relay
- Fourth line in display:
 - Time; the current time in this example is *10:00A* which represents 10:00 AM
 - Date; the current month, day and year in this example is *01* for January, *21* for the 21st day of the month and *10* for the year 2010
 - Device Address; *ID001* in this example *I* represents SLC Loop, *D* represents a detector, and *001* represents device address 001

Pressing the *Acknowledge/Step* or *Alarm Silence* key will cause the pulsing piezo to silence and the system Trouble LED to change from flashing to on steady. This block acknowledgment occurs regardless of the number of troubles, alarms and supervisory events active in the system. When the *Acknowledge/Step* key is pressed and at least one new alarm or trouble exists in the system, the ‘acknowledge’ message is sent to the printer and history file. If the trouble clears, either before or after the *Acknowledge/Step* key is pressed, the ‘clear trouble’ message is sent to the printer and history file.

If all troubles clear and there are no supervisory or fire conditions active in the system, the system returns to normal mode operation and the *System All Normal* message is shown on the LCD display and sent to the history and printer files. The auto-restore feature will restore cleared troubles even if the troubles were never acknowledged. Note that pressing the *Alarm Silence* key when only troubles exist in the system will have the same effect as pressing the *Acknowledge/Step* key except the Alarm Silenced LED will light.

4.5 Alarm Operation

Alarm operation is similar to trouble operation with the following differences:

- The piezo sounder produces a steady output as opposed to a pulsed output
- The Fire Alarm LED flashes 1 second On and 1 second Off
- The LCD displays *Alarm* along with the device name, type, address, adjective/noun, associated zones and time/date
- Communicate the alarm to the Central Station
- Alarms latch and *are not allowed to clear automatically*
- Alarms activate software zones if so programmed
- Timers for Silence Inhibit, Autosilence and Trouble Reminder are started
- Alarms activate the general alarm relay and general alarm zone Z00
- The trouble relay is not activated
- Store event in history buffer
- Terminate upload or download communications

A typical alarm display would be as illustrated below:



Note that the device type, which in this example is *PULL STATION*, can be any other programmable alarm type.

The information displayed in the above example provides the following information:

- First line in display:
 - The type of event; in this example *ALARM* indicating an alarm condition
 - Device type identifier; in this example, *PULL STATION* indicates a manual pull box. Other device type identifiers which can be displayed include *SMOKE (ION)* for Ionization Detector, *HEAT* for Heat Detector, *CONTROL* for Control Module, and *MONITOR* for Monitor Module, *PULL STATION* for a manual pull box, etc. Refer to “*Edit Detector*” on page 59, “*Edit Module Screen for Monitor Module*” on page 69 and “*Edit Module Screen for Control Modules*” on page 78 for information on additional device types.
- Second line in display:
 - <ADJ>; refers to the user programmed adjective descriptor from library list resident in the control panel or custom entry via PC.
 - <NOUN>; refers to the user programmed noun descriptor from library list resident in the control panel or custom entry via PC.
- Third line in display: *Z000* indicates the zone programmed to this device which, in this example, is general alarm Zone 000. Note that a single device can be programmed to five different zones but only the first zone will be displayed.
- Fourth line in display:
 - Time; the current time in this example is *10:00A* which represents 10:00 AM
 - Date; the current month, day and year in this example is *01* for January, *21* for the 21st day of the month and *10* for the year 2010
 - Device Address; *1M001* in this example *1* represents SLC Loop, *M* represents a module, and *001* represents device address 001

4.6 Supervisory Operation

Supervisory operation is similar to alarm operation but with the following differences:

- The piezo sounder pulses ½ second On and ½ second Off
- The Supervisory LED flashes ½ second On and ½ second Off
- The LCD displays the status label *Active Supervisory* along with the device name, type, address, adjective/noun, associated zones, and time/date
- Communicate the supervisory condition to the Central Station
- The supervisory relay is activated
- The alarm relay is not activated
- Silenced alarms are resounded
- Timers are not started
- Store event in history buffer
- Terminate upload or download communications

A typical Supervisory event would be displayed as illustrated in the following:

```

ACTIVE SUPERVISORY
<ADJ> <NOUN>
                Z000
10:00A 012110 1M001
  
```

Note that, like alarms, supervisory signals latch (except when programmed for supervisory autore-settable) and can be assigned to software zones. Supervisory alarms do not cause resound as do other alarm conditions. Open circuits in supervisory wiring are processed by the control panel the same way as other trouble conditions. Refer to “Alarm Operation” on page 151, for a description of the information displayed on the control panel LCD.

4.7 Process Monitor Operation

Process Monitor operation will initiate the following events:

- The piezo sounder pulses ¼ second On and ¼ second Off
- The LCD displays a process monitor message along with the device name, type, address, adjective/noun, associated zones, and time/date
- Communicate the process monitor condition to the Central Station (if the default event code has been changed from 000 to a reportable event code)
- Relays programmed for process monitoring will be activated
- The alarm relay is not activated
- Fire Alarm NACs will not activate
- SLC NACs (control modules) will activate
- Timers are not started
- Store event in history buffer
- Activate appropriate LED on the ANN-LED annunciator (required for this application)
- Each ANN-LED can support up to 10 zones.

Note that, like supervisories, process monitor signals latch (except when programmed for process monitor autoresettable) and can be assigned to software zones.

4.8 Hazard/Tornado Condition Operation

Hazard/Tornado operation is intended for Manual activation.

Hazard/Tornado Condition operation will initiate the following events:

- The piezo sounder pulses ¼ second On, ¼ second Off
- The LCD displays a hazard message along with the device name, type, address, adjective/noun, associated zones, and time/date
- Communicate the hazard condition to the Central Station (if the default event code has been changed from 000 to a reportable event code)
- Relays programmed for hazard will be activated
- The alarm relay is not activated
- Fire Alarm NACs will not activate
- SLC NACs (control modules) will activate
- Timers are not started
- Store event in history buffer

- Activate appropriate LED on the ANN-LED annunciator (required for this application)
- Each ANN-LED can support up to 10 zones.

Hazard conditions latch. They can be assigned to software zones.

4.9 Medical Alert Condition Operation

Medical alert operation is:

- not intended for nurse call stations (applications) per UL1069.
- not intended for signaling professional medical staff.
- to be used for summoning security guards or other trained personnel within the facility
- intended for Manual activation.

Medical Alert Condition operation will initiate the following events:

- The piezo sounder ¼ second On, ¼ second Off
- The LCD displays a medical alert message along with the device name, type, address, adjective/noun, associated zones, and time/date
- Communicate the medical alert condition to the Central Station (if the default event code has been changed from 000 to a reportable event code)
- Relays programmed for medical alert will be activated
- The alarm relay is not activated
- Fire Alarm NACs will not activate
- SLC NACs (control modules) will activate
- Timers are not started
- Store event in history buffer
- Activate appropriate LED on the ANN-LED annunciator (required for this application)
- Each ANN-LED can support up to 10 zones.

Medical alert conditions latch. They can be assigned to software zones.

4.10 NAC Operation

There are two programmable NACs (Notification Appliance Circuits) resident on the MS-9050UD main circuit board which can be wired for Style Y (Class B) or Style Z (Class A). Both NACs may be programmed as silenceable or nonsilenceable and may also be programmed for steady or coded operation. Coded operation provides a choice between March Time, Temporal or California coding.

4.11 Programmed Zone Operation

Each addressable detector and monitor module can be assigned to a maximum of five software alarm zones. A general alarm zone Z00 may be listed for output (control) points, but it is not necessary to list Z00 for input points, since this is the default zone for all alarm input devices. Zone Z00 is not activated by supervisory points.

When an input device alarms and is not disabled, it activates all software zones assigned to it. An output device that is not disabled is turned on when any of the software zones to which it is programmed become active. Only fire alarms can turn on any of the two main NACs.

Note that hazards/tornado alerts do not turn on the two main NACs.

4.12 Disable/Enable Operation

Input points which are disabled do not cause an alarm or any zone activation. Disabled output points are held in the off state. All disabled points are treated as if they were in trouble, with the exception being the status label that will be displayed is *DISABL*.

4.13 Waterflow Circuits Operation

If an alarm exists from a monitor module point that has a waterflow type code and its mapped NAC control module outputs are programmed for nonsilenceable operation, the Alarm Silence key will not function. Also, any output zone activated by a waterflow device will not be silenceable if the Waterflow Silenceable option is set to NO in system programming.

4.14 Detector Functions

Maintenance Alert

Each addressable detector is monitored by the control panel for its maintenance status. If a detector is near but below the allowed alarm limit, a 'maintenance alert' message will automatically be displayed, signaling that the detector is in need of servicing.

Automatic Test Operation

An automatic test of an addressable detector is performed each minute, resulting in a complete SLC loop test in approximately 1 hour (if the loop has the maximum number of devices installed). The detector's sensing chamber and electronics are functionally tested for normal, safe operation. A trouble message is displayed upon failure of this test. A System Reset will clear this trouble.

Type Code Supervision

The FACP monitors addressable hardware device codes at slow intervals. Mismatch of any type code, compared to the system program, will cause a device trouble.

System Alarm Verification

The control panel may be programmed to perform alarm verification to help eliminate the nuisance of false alarms. Alarm verification applies to smoke detectors only.

Smoke Detector Data

Smoke detector data is monitored by the FACP, eliminating the need to test the sensitivity of each detector at its location. A printout of each detector's data can be retrieved from the FACP using an optional printer or Windows® HyperTerminal. Detector sensing ability can decrease with age and should be monitored as part of a system's routine maintenance.

4.15 Time Functions: Real-Time Clock

The MS-9050UD includes a crystal-based clock that provides time of day, date and day of week. Time is displayed as 12 or 24 hour time with month/day/year and is stored in RAM. Daylight savings time change-over is programmable and automatic. If both AC and battery are lost, the time must be reset.

4.16 Synchronized NAC Operation

Synchronization is a panel feature that controls the activation of notification appliances in such a way that all devices will turn on and off at exactly the same time. This is particularly critical when activating strobes which must be synchronized to avoid random activation and a potential hazard or confusion. The FACP can be programmed to operate with a variety of manufacturer's devices.

Important: When a Notification Appliance Circuit with a mix of audible and visual devices is programmed for silenceable and the synchronization feature is selected, only the audible devices will be turned off if the Silence key is pressed. The visual devices (strobes, etc.) will continue to operate.

4.17 Coded Operation

The NAC circuits resident on the control panel main circuit board can be programmed for coded operation. The available pulse rates which can be programmed for coded operation are as follows:

- Continuous: Steady output with no pulsing
- March Time: Pulses at 120 ppm (pulses per minute)
- Temporal Code: Pulses at ½ second On, ½ second Off, ½ second On, ½ second Off, ½ second On, 1½ second Off
- California Code: 10 seconds On, 5 seconds Off
- Two-Stage Pulses at 20 ppm (pulses per minute) for 3 or 5 minutes and then changes to Temporal

4.18 Presignal

Presignal option programs an initiating device to delay the activation of NACs and/or control modules while allowing visual verification by a person. Once a detector or monitor module triggers an alarm, the onboard piezo sounds immediately, but the NACs are not activated for a user programmed time duration of up to three minutes. Note that the alarm relay and communicator will respond to the initial alarm immediately. In addition, Zone 18 will activate. This zone can be programmed to a control module which may be used to activate a sounder or indicator which the installer designates as a Presignal indication. *Do not assign Zone 18 to a Notification Appliance Circuit when using this zone to indicate a Pre-signal condition.*

After the programmed delay, the NACs will activate if the source of the alarm is not cleared. Note that if a second alarm occurs during the programmed time delay, the alarm will be processed immediately, causing activation of the appropriate output zones. The events which occur upon Presignal activation are as follows:

- ✓ onboard piezo sounds immediately
- ✓ control panel LCD display will indicate a presignal event and the active point
- ✓ control points programmed to Zone 18 will activate
- ✓ annunciators (if enabled) will sound the local piezo, and pulse the alarm LED and zone LED
- ✓ outputs (NACs and control modules) of associated zones will be inhibited from activating for a user programmed time delay of up to three minutes
- ✓ second alarm occurring anytime during the time delay will cause immediate activation of all associated outputs

Presignal does not affect monitor modules programmed as waterflow, supervisory, process monitoring or remote switches. *Presignal operation requires the approval of the local Authority Having Jurisdiction.*

4.19 Positive Alarm Sequence

PAS (Positive Alarm Sequence) option will program a detector to delay panel activation (including alarm relay and communicator) for a period of 15 seconds. Zone 17, however, will activate immediately and may be used to connect a signaling device to indicate PAS activation. *Do not assign Zone 17 to a Notification Appliance Circuit when using this zone to indicate a PAS condition.*

When a detector triggers an alarm, the onboard piezo sounds immediately, but the NACs are prevented from activating for 15 seconds. This inhibit time is factory set and cannot be changed. Pressing the Alarm Silence or Acknowledge/Step key during the 15 second inhibit time will silence the piezo sounder and start a timer which prevents activation of NACs for an additional time duration which can be user programmed for up to three minutes. After the programmed delay, the NACs will activate if the source of the alarm is not cleared. Note that if a second alarm occurs during either time delay, the alarm will be processed immediately, causing activation of the appropriate output zones. The events which occur upon PAS activation are as follows:

- ✓ onboard piezo sounds immediately
- ✓ control panel LCD display will indicate a presignal event and the active point
- ✓ control points programmed to Zone 17 will activate
- ✓ annunciators (if enabled) will sound the local piezo, and pulse the alarm LED and zone LED
- ✓ outputs (NACs and control modules) of associated zones will be inhibited from activating for a factory set duration of 15 seconds
- ✓ pressing the Alarm Silence or Acknowledge/Step key will start a timer which inhibits output activation for additional time delay of up to three minutes which is user programmable
- ✓ second alarm occurring anytime during either time delay will cause immediate activation of all associated outputs

PAS operation requires the approval of the local Authority Having Jurisdiction.

Note that the *PAS BYPASS* monitor type code, when activated, will inhibit the PAS capability until the *PAS BYPASS* monitor is deactivated. While PAS is inhibited, signaling devices will immediately place the control panel into alarm. This feature may be employed by wiring a normally open device, such as a switch, to a monitor module which has been programmed for *PAS BYPASS*.

4.20 Special System Timers

4.20.1 Silence Inhibit Timer

This option, if selected, prevents the *Alarm Silence* key from functioning for 60 seconds following an alarm. A new alarm during the initial 60 second period will not cause the timer to restart with a new 60 seconds. *Silence Inhibit operation requires the approval of the local Authority Having Jurisdiction.*

4.20.2 Autosilence Timer

If Autosilence is selected, the notification appliances, programmed as silenceable, will automatically be silenced after a programmable duration of from 5 to 30 minutes. Pressing the *Drill* key will restart the timer. *Autosilence operation requires the approval of the local Authority Having Jurisdiction.*

4.20.3 Trouble Reminder

If selected, this feature causes a reminding ‘beep’ every 15 seconds during an alarm (after the *Alarm Silence* key is pressed) and every two minutes during a trouble condition (after the *Acknowledge/Step* or *Alarm Silence* key is pressed). The ‘beeps’ from the onboard piezo sounder will occur until the alarm or fault is cleared.

Note that enabling/disabling the Trouble Reminder feature has no effect on Trouble Resound. When an existing trouble in the system is silenced, if the trouble condition is not cleared before midnight, the piezo will resound, indicating that the trouble condition still exists.

4.20.4 Waterflow Retard Timer

If selected, this option will delay the activation of a waterflow type alarm for a programmable time duration from 1 to 90 seconds. This delay is in addition to any time delay inherent in the waterflow device. *This feature requires the approval of the local Authority Having Jurisdiction.*

4.20.5 Alarm Verification (None or One Minute)

If alarm verification is selected, an addressable smoke detector's alarm is ignored for a retard time of 23 seconds and the detector's alarm condition is automatically reset. There will be no alarm indication at the FACP during the Retard period. A confirmation period of 60 seconds follows, during which a subsequent alarm from the same detector will cause the panel to immediately activate the appropriate outputs and indicate the alarm condition at the FACP. If a different detector alarms any time during the first detector's verification period, the panel will immediately activate all appropriate outputs and indicate the alarm condition at the FACP. If no additional detector alarms occur within 83 seconds of the first alarm (23 second retard plus 60 second confirmation), the timer resets and the panel is ready to verify any new detector alarms which may occur.

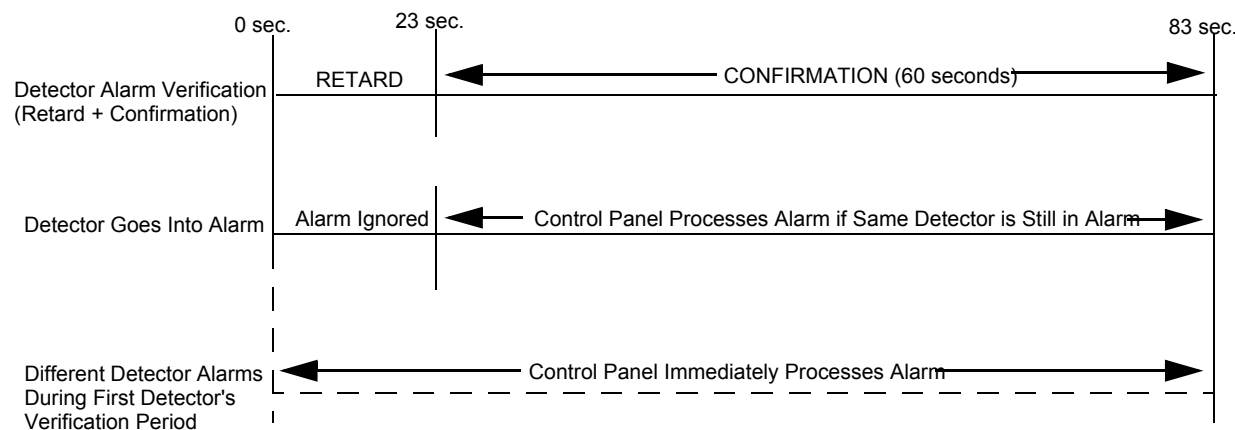

NOTE: Alarm Verification is available only for addressable smoke detectors, not conventional smoke detectors.

4.21 Walktest

Walktest is a feature which allows one person to test the fire alarm system. An audible walktest will momentarily sound the Notification Appliance Circuits in the building and store the walktest information in a file at the panel. A silent walktest will not sound the NACs but will store the walktest information in a file which can be viewed at the panel. Disabled NAC devices will not activate during walktest.

Alarm/Shorted Condition

When in audible Walktest, the panel responds to each new alarm and activates its programmed control outputs for four seconds, if those outputs have been programmed for silenceable activation. It also stores each alarm in the walktest history file which can be sent to an optional printer. The stored display will be the same as if the device actually activated except the colon (:) in the time stamp is replaced with an asterisk (*).

Open Condition

Addressable devices as well as all main circuit board NACs are monitored for fault conditions during Walktest mode. When a new trouble condition occurs, the FACP will activate all NACs and control modules programmed for Walktest, then shut them off after eight seconds.

While in Walktest, the trouble relay is activated and the system Trouble LED flashes (as in all of the Program and status change operations). The alarm relay is not activated.

4.22 Read Status

Read Status functions do not require a password. The control panel will continue to provide fire protection while in Read Status mode. This mode can be entered while the control panel is in alarm or trouble. If a new alarm or trouble occurs during these functions, the Read Status is exited to prevent confusion.

Read Status Entry

When the operator presses the control panel *Enter* key, the LCD will display the following:

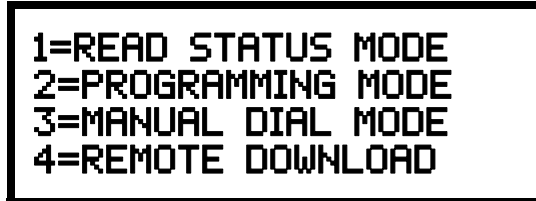

```
1=READ STATUS MODE
2=PROGRAMMING MODE
3=MANUAL DIAL MODE
4=REMOTE DOWNLOAD
```

Pressing *1*, while this screen is being displayed, will cause the control panel to enter the Read Status mode which allows the user to view and print the programmed features and status of the control panel.

The following screens will be displayed:

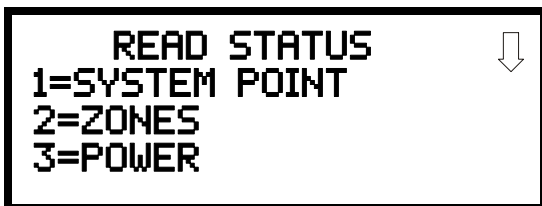

Read Status Screen #1



Read Status Screen #2

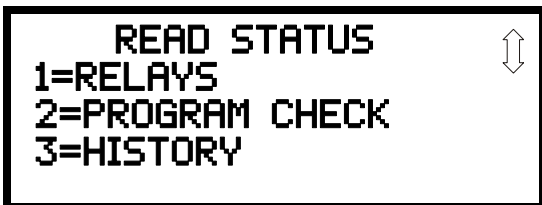

Read Status Screen #3

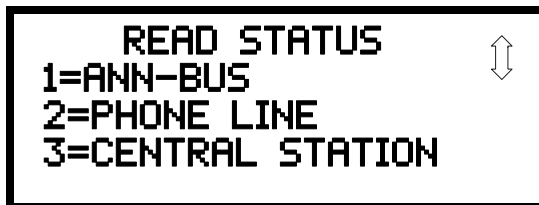

Read Status Screen #4



Read Status Screen #5

4.22.1 System Point

Pressing *I* while viewing Read Status Screen #1 will cause the following screen to be displayed:

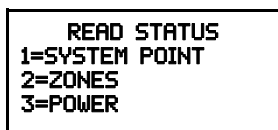

Read Status Screen #1

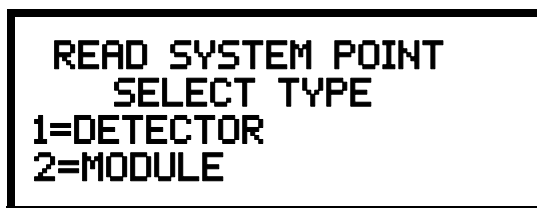

The operator selects the type of device which is to be viewed by pressing *1* for Detector or *2* for Module. If *1* is pressed, the display will change to the following screen:

```

READ SYSTEM POINT
ENTER DETECTOR#
***

```

Entering the three digit detector address will cause the control panel to display the current status of the selected device. For example, if a detector with address *001* on the SLC loop is entered, a display similar to the following will appear:

```

NORMAL SMOKE(PHOTO)
NORTH CLASSROOM
      Z005
      V  10001

```

The information in the preceding display includes:

- *NORMAL* - the present status (could also be ALARM, TROUBL, DISABL, etc.)
- *SMOKE (PHOTO)* - the device type which is a photoelectric smoke detector (could also be ION for ionization smoke detector)
- *NORTH CLASSROOM* - the Adjective/Noun label for this device
- *Z005* - the first of five possible assigned software zones
- *ID001* - *I* = SLC Loop, *D* = Detector, *001* = Address 001
- *V* - Alarm Verification Enabled (*V* = Yes, * = No)
- *S* - Silenceable for control modules (*S* = Yes, * = No)
- *W* - Walktestable for control and monitor modules (*W* = Yes, * = No)

Pressing the down arrow key, while viewing the screen shown above, will allow the operator to view additional programming information about the selected device, such as:

- Enable/Disable Status
- Device Type
- Alarm Verification On/Off (for detectors)
- Walktest Yes/No
- PAS (Positive Alarm Sequence) Yes/No (for detectors only)
- Pre-Signal Yes/No (for detectors and monitor modules)
- Zone Assignments (five maximum)
- Adjective/Noun descriptor
- Silenceable Yes/No (for control modules)

4.22.2 Zones

Pressing 2 while viewing Read Status Screen #1 will cause the following screens to be displayed:

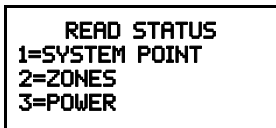

Read Status Screen #1



Zones Screen #1

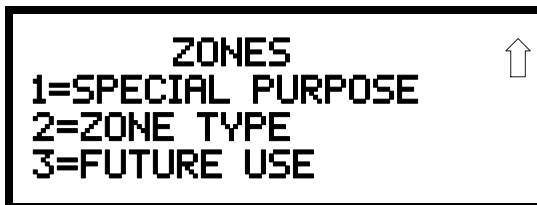

Zones Screen #2

From the preceding screens, the control panel operator can view:

- *Zones Installed* - all software zones programmed into the system (20 maximum)
- *Zones Enabled* - all software zones that are enabled
- *Zones Disabled* - all software zones that have been disabled
- *Special Purpose* - on or off programming for Special Purpose Zones 17 reserved for PAS, 18 reserved for Pre-signal and 19 reserved for Two Stage Operation
- *Zone Type* - the Type assigned to each installed zone (default is Alarm)

4.22.3 Power

Pressing 3 while viewing Read Status Screen #1 will cause the following screens to be displayed:

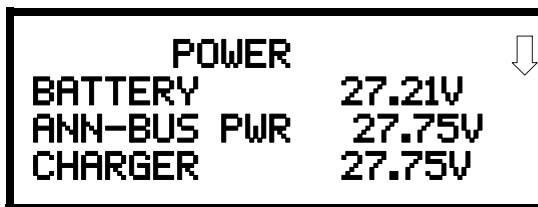

Power Screen #1

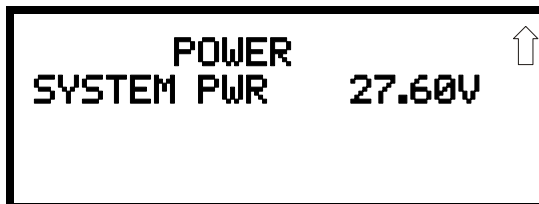

Power Screen #2

A real-time display of the control panel voltages can be used to determine if a problem exists in the system.

The following table lists the circuit being measured, possible conditions and their respective voltage ranges:

Circuit	Condition	Voltage Range
Battery	Normal Battery (nominal)	27.05 to 28.15 VDC
	Low Battery	17.7 to 20.4 VDC
	No Battery	0 to 17.6 VDC
ANN-BUS Power	Normal	21.25 to 27.50 VDC
Charger	Normal	21.87 to 29.84 VDC
System Power	Nominal	27.60 VDC

4.22.4 Trouble Reminder

READ STATUS
1=TROUBLE REMINDER
2=TIMERS
3=NAC

Read Status Screen #2

Pressing 1 while viewing Read Status Screen #2 will display the following screen:

```

TROUBLE REMINDER
TROUBLE REM      ON
  
```

The screen indicates whether the Trouble Reminder feature is On or Off. The factory default setting is *Trouble Rem OFF*.

4.22.5 Timers

Pressing 2 while viewing Read Status Screen #2 will cause the following Timer screens to be displayed:

```

          TIMERS
PAS DELAY      000
PRE SIGNAL     000
WATERFLOW     000
  
```

```

          TIMERS
AC LOSS DELAY  2
  
```

These screens will indicate the delay time, in seconds, for each of the first three possible delay options. The AC Loss Delay time is displayed in hours.

4.22.6 NAC

Pressing *3* while viewing Read Status Screen #2 will display the following screen:

```
          NAC
1=NAC 1
2=NAC 2
```

The operator can press *1* to view the programmed options for NAC 1 or *2* to view the programmed options for NAC 2. The resulting screens will display the following information:

- Enable/Disable Status
- Circuit Type (Bell, Strobe, etc.)
- Silenceable/Nonsilenceable
- Auto Silence Enable/Disable and time delay (in minutes)
- Coding Selection (Temporal, Steady, etc.)
- Zone Assignments
- Silence Inhibit Enabled/Disabled
- Synchronization Type (System Sensor, Wheelock, or Gentex)

4.22.7 Relays

Pressing *1* while viewing Read Status Screen #3 will display the following screen:

```
  READ STATUS
1=RELAYS
2=PROGRAM CHECK
3=HISTORY
```

Read Status Screen #3

```
          RELAY
1=RELAY 1
2=RELAY 2
3=RELAY 3
```

The operator can view the programmed option for each relay by pressing the corresponding number key.

4.22.8 Program Check

Pressing 2 while viewing Read Status Screen #3 will cause a screen similar to the following to be displayed:

```
PROGRAM CHECK
1=NACS NO INPUT
2=ZONES NO INPUT
3=ZONES NO OUTPUT
```

Pressing 1 while viewing the Program Check screen will display a screen which will indicate if any input zones have not been programmed to one of the Notification Appliance Circuits. Use the up and down arrow keys to view all NACs.

Pressing 2 while viewing the Program Check screen will display a screen which will indicate if any output zones have not been programmed to at least one input zone. Use the up and down arrow keys to view all zones.

Pressing 3 while viewing the Program Check screen will display a screen which will indicate if any input zones have not been programmed to at least one output zone. Use the up and down arrow keys to view all zones.

4.22.9 History

Pressing 3 while viewing Read Status Screen #3 will display the following screen:

```
HISTORY
1=VIEW ALL
2=VIEW ALARMS
3=VIEW OTHER EVENTS
```

The operator can view all events which have been stored in the history file, only alarms or other events, such as troubles or supervisories, by pressing the corresponding number key.

4.22.10 ANN-BUS

Pressing *1* while viewing Read Status Screen #4 will display the following screens:

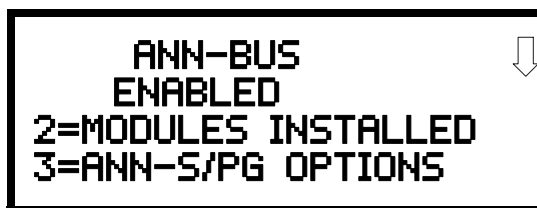

ANN-BUS Screen #1

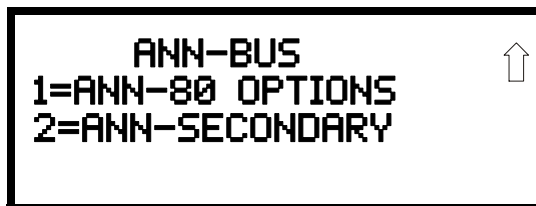

ANN-BUS Screen #2

Pressing *2* for *Modules Installed*, while viewing ANN-BUS Screen #1 will display screens with ANN-BUS Addresses 1 through 8. Selecting an address will display information about the device which has been assigned that address.

Pressing *3* for *ANN-S/PG Options*, while viewing ANN-BUS Screen #1 will display screens detailing the setting for the ANN-SPG printer installed. This information includes:

- Port Parallel/Serial
- Printer Supervision Yes/No
- Off Line Timer setting
- Baud Rate
- Data Bits
- Parity
- Stop Bits

Pressing *1* for *ANN-80 Options*, while viewing ANN-BUS Screen #2 will display screens detailing the settings for this device. The information includes:

- Piezo Enable/Disable
- Lock Enable/Disable
- Acknowledge Button Enable/Disable
- Silence Button Enable/Disable
- Reset Button Enable/Disable
- Drill Button Enable/Disable

Pressing *2* for *ANN-SECONDARY Options*, while viewing ANN-BUS Screen #2 will display screens detailing the settings for this device and would display the following screen:

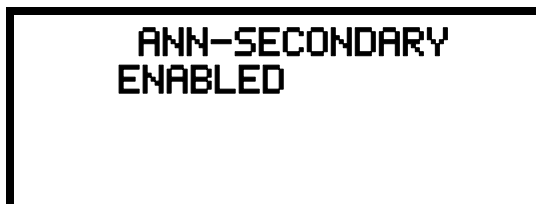

ANN-SECONDARY Screen #2

4.22.11 Phone Line

Pressing 2 while viewing Read Status Screen #4 will display the following screen:

```

PHONE LINE
PRIMARY TOUCHTONE
SECONDARY TOUCHTONE
  
```

This screen indicates the both the Primary and Secondary phone lines have been configured for touchtone dialing operation.

4.22.12 Central Station

Pressing 3 while viewing Read Status Screen #4 will display the following screens:

```

READ STATUS
1=ANN-BUS
2=PHONE LINE
3=CENTRAL STATION
  
```

Read Status Screen #4

```

CENTRAL STATION
REPORTING      ENABLED
REPORT        BOTH
CALL LIMIT    10
  
```

Central Station Screen #1

```

CENTRAL STATION
1=PRIMARY
2=SECONDARY
3=REPORT STYLE
  
```

Central Station Screen #2

Central Station Screen #1 indicates whether the Central Station Reporting is enabled or disabled, if the Reports will be sent to one or both the Primary and Secondary Central Station phone numbers and the Call Limit for DACT trouble calls within a 24 hour period. Central Station Screen #2 provides information on the Primary and Secondary Central Station programming which includes:

- Test Time Interval
- Account Code
- 24 Hour Test Time
- Phone Number
- Communication Format
- Event Codes

4.22.13 Service Terminal

Pressing *1* for *Ring Count*, while viewing Read Status Screen #5 will display the following screens:

```

READ STATUS
1=RING COUNT
2=PRINT
3=TIME-DATE

```

Read Status Screen #5

```

SERVICE TERMINAL
RING COUNT      03

```

Service Terminal Screen

4.22.14 Print

To print program data or control panel status, press *2* while viewing Read Status Screen #5. The following screens will be displayed:

```

READ STATUS
1=SERVICE TERMINAL
2=PRINT
3=TIME-DATE

```

Read Status Screen #5

```

PRINT
1=HISTORY
2=WALKTEST LOG
3=WALKTEST SUMMARY

```

Print Screen #1

```

PRINT
1=DETECTOR DATA
2=DACT SUMMARY
3=EXIT PRINTING

```

Print Screen #2

Pressing *1* while viewing Print Screen #1 allows the user to print the History file which will detail all of the system activities since the file was last cleared from memory.

Pressing *2* while viewing Print Screen #1 allows the user to print the Walktest log which will detail all of the system activations during walktest since the log was last cleared. Refer to “Walktest” on page 106 for additional information on the display.

Pressing *3* while viewing Print Screen #1 allows the user to print the Walktest summary. This screen will display a total of the tested detectors, tested modules, untested detectors and untested modules for the current walktest session. Refer to “Walktest” on page 106 for additional information on the display.

Pressing *1* while viewing Print Screen #2 allows the user to print the detector data for each addressable smoke detector connected to the system. A printout, similar to the following example, will be generated if an optional printer is connected to the FACP.

DEVICE #	DEVICE TYPE	% DRIFT COMP	CHAMBER	TIME/DATE
1D001	SMOKE (PHOTO)	20	1281	12:01AM 01-08-2010
1D002	SMOKE (PHOTO)	20	1281	12:01AM 01-08-2010
1D003	SMOKE (PHOTO)	21	1259	12:01AM 01-08-2010
1D004	SMOKE (PHOTO)	20	1309	12:02AM 01-08-2010
1D005	SMOKE (PHOTO)	21	1281	12:02AM 01-08-2010
1D006	SMOKE (PHOTO)	20	1322	12:02AM 01-08-2010
1D007	SMOKE (PHOTO)	20	1280	12:02AM 01-08-2010
1D008	SMOKE (PHOTO)	20	1215	12:02AM 01-08-2010
1D009	SMOKE (PHOTO)	20	1310	12:02AM 01-08-2010

Chamber Value

The Chamber value should be within the indicated range for the following smoke detectors:

- SD350(T), SD355(T), D350P(R), D355P(R), SD300(T), AD350, and AD355 Addressable Photoelectric Smoke Detectors: **405 - 2100** (obscuration of 1.00%/ft to 3.66%/ft.)
- CP350, CP355 and CP300 Addressable Ionization Smoke Detectors: **750 - 2100** (obscuration of 0.50%/ft. to 1.44%/ft.)

If the addressable smoke detector's Chamber reading is not within the acceptable range, clean the detector and check the Chamber value again. If the reading is still not within the acceptable range, immediately replace the detector.

Drift Compensation

Drift compensation uses software algorithms that identify and compensate for long-term changes in the data readings from each addressable smoke detector. These long-term changes in detector data readings are typically caused by dirt and dust accumulation inside the smoke chamber. Drift compensation performs the following functions:

- Samples each photoelectric smoke detector every 6 seconds and each ionization smoke detector every 3 seconds
- Allows a smoke detector to retain its original ability to detect actual smoke and resist false alarms, even as dirt and dust accumulate
- Reduces maintenance requirements by allowing the control panel to automatically perform the periodic sensitivity measurements required by NFPA Standard 72

The FACP software also provides filters to remove transient noise signals, usually caused by electrical interference.

Maintenance Alert

The software determines when the drift compensation for a detector reaches an unacceptable level that can compromise detector performance. When a detector reaches an unacceptable level, the control panel indicates a maintenance alert. Table 4.1 summarizes the three levels of maintenance alert:

Maintenance Level	FACP Status Displays	Indicates
Low Chamber Value	INVREP	A hardware problem in the detector
Maintenance Alert	DIRTY1	Dust accumulation that is near but below the allowed limit. <i>DIRTY 1</i> indicates the need for maintenance before the performance of the detector is compromised
Maintenance Urgent	DIRTY2	Dust accumulation above the allowed limit.

Table 4.1 Maintenance Alert Levels

Figure 4.1 illustrates a graphic representation of the maintenance levels:

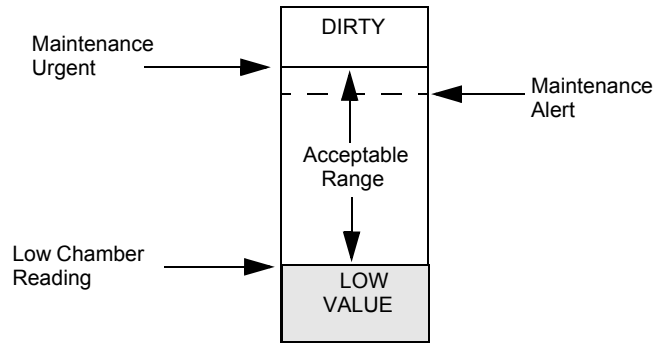

Figure 4.1 Diagram of Maintenance Levels

Pressing 2 while viewing Print Screen #2 allows the user to print the DACT summary which will detail all of the onboard DACT settings. Refer to “Onboard DACT” on page 120 for additional information on the display.

Pressing 3 while viewing Print Screen #2 exits the user from the print menu.

4.22.15 Time-Date

The operator can view the daylight savings time and the month and week when daylight savings time will begin and end. Pressing 3 while viewing Read Status Screen #5 will display the following screens:

```

READ STATUS
1=SERVICE TERMINAL
2=PRINT
3=TIME-DATE
    
```

Read Status Screen #5

```

DAYLIGHT SAVINGS  ↓
ENABLED           YES
START MONTH      MAR
START WEEK       WEEK 2
    
```

```

DAYLIGHT SAVINGS  ↑
END MONTH        NOV
END WEEK         WEEK 1
    
```

Notes

Section 5: Central Station Communications

The control panel transmits zone and system status reports to Central Stations via the public switched telephone network. Two supervised telephone line connections are made to interface the control panel to the telephone lines. Two optional 7 foot telephone cords are available for this purpose and can be purchased separately.

The control panel supervises both telephone lines for proper voltage. A delay of two minutes will occur before a fault in either phone line connection is reported as a trouble. When a fault is detected, an audible trouble signal will sound, the yellow trouble LED will blink, the LCD display will indicate the phone line trouble and the trouble condition will be reported to the Central Station over the remaining operational phone line.

The control panel comes with line seizure capability provided for both the primary and secondary telephone line interfaces. Any time that the control panel needs to make a call to a Central Station, line seizure will disconnect any local premises phones sharing the same telephone line.

All transmissions to the Central Stations will be sent over the primary phone line. In the event of noisy phone lines, transmissions will be sent over the backup secondary phone line.

Two phone numbers must be programmed, the primary Central Station phone number and the secondary Central Station phone number. All system reports will be transmitted to the primary Central Station phone number. Reports will automatically be sent to the secondary Central Station phone number if attempts to transmit to the primary Central Station phone number are unsuccessful. If 10 total attempts to communicate are unsuccessful, a Communicator Failure report will be displayed. Note that as an option, *all* reports may also be sent to the secondary Central Station phone number.

The MS-9050UD meets NFPA 72 National Fire Code reporting requirements for: (a) the type of signal, (b) condition and (c) location of the reporting premises. The general priority reporting structure is:

1. Zone Alarms and Restores
2. Zone Troubles and Restores
3. System Troubles and Restores
4. 24-hour Test

The control panel is capable of reporting detailed messages depending upon the format in use. Table 5.1 shows the reporting structure for all formats.

	Format	Format	Format	Format
Report	3+1/4+1/Standard 4+1 Express	3+1/4+1/Expanded	4+2/Standard 4+2 Express	4+2/Expanded
Alarm	SSS(S) A	SSS(S) A AAA(A) Z	SSSS AA2	SSSS AZ
Alarm Restore	SSS(S) RA	SSS(S) RA RARARA(RA) Z	SSSS RARA2	SSSS RAZ
Zone Trouble (Zone Open)	SSS(S) TZ	SSS(S) TZ TZTZ(TZ) Z	SSSS TZTZ2	SSSS TZZ
Zone Trouble Restore	SSS(S) RTZ	SSS(S) RTZ RTZRTZRTZ(RTZ) Z	SSSS RTZRTZ2	SSSS RTZZ
System Trouble	SSS(S) TS	SSS(S) TS TSTSTS(TS) Y	SSSS TSTS2	SSSS TSY
System Trouble Restore	SSS(S) RTS	SSS(S) RTS RTSRTSRTS(RTS) Y	SSSS RTSRTS2	SSSS RTSY
Zone Disable	SSS(S) DZ	SSS(S) DZ DZDZDZ(DZ) Z	SSSS DZDZ2	SSSS DZZ
Zone Disable Restore	SSS(S) RDZ	SSS(S) RDZ RDZRDZRDZ(RDZ) Z	SSSS RDZRDZ2	SSSS RDZZ
Low Battery	SSS(S) L	SSS(S) L LLL(L) L2	SSSS LL2	SSSS LL2
Low Battery Restore	SSS(S) RL	SSS(S) RL RLRLRL(RL) RL2	SSSS RLRL2	SSSS RLRL2
AC Loss	SSS(S) P	SSS(S) P PPP(P) P2	SSSS PP2	SSSS PP2
AC Loss Restore	SSS(S) RP	SSS(S) RP RPRPRP(RP) RP2	SSSS RPRP2	SSSS RPRP2
Fire Drill	SSS(S) FD	SSS(S) FD FDFDFD(FD) FD2	SSSS FDFD2	SSSS FDFD2
Fire Drill Restore	SSS(S) RFD	SSS(S) RFD RFDRFDRFD(RFD) RFD2	SSSS RFDRFD2	SSSS RFDRFD2
Supervisory Condition	SSS(S) V	SSS(S) V VVV(V) Z	SSSS VV2	SSSS VZ
Supervisory Condition Restore	SSS(S) RV	SSS(S) RV RVRVRV(RV) Z	SSSS RVRV2	SSSS RVZ
Test Report	SSS(S) X	SSS(S) X	SSSS XX2	SSSS XX2
Upload or Download	SSS(S) UD	SSS(S) UD	SSS UDUD2	SSS UDUD2

Table 5.1 Format Selection

Refer to Table 5.2 for an explanation of each letter code in Table 5.1. Refer to Table 5.3 for a list of compatible receivers.

Where	
SSS or SSSS	= Subscriber ID
A	= Alarm (1st digit)
A2	= Alarm (2nd digit)
Z	= Zone Number
RA	= Alarm Restore (1st digit)
RA2	= Alarm Restore (2nd digit)
TZ	= Zone Trouble (1st digit)
TZ2	= Zone Trouble (2nd digit)
RTZ	= Zone Trouble Restore (1st digit)
RTZ2	= Zone Trouble Restore (2nd digit)
TS	= System Trouble (1st digit)
TS2	= System Trouble (2nd digit)
RTS	= System Trouble Restore (1st digit)
RTS2	= System Trouble Restore (2nd digit)
DZ	= Zone Disable (1st digit)
DZ2	= Zone Disable (2nd digit)
RDZ	= Zone Disable Restore (1st digit)
RDZ2	= Zone Disable Restore (2nd digit)
L	= Low Battery (1st digit)
L2	= Low Battery (2nd digit)
RL	= Low Battery Restore (1st digit)
RL2	= Low Battery Restore (2nd digit)
P	= AC Loss (1st digit)
P2	= AC Loss (2nd digit)
RP	= AC Loss Restore (1st digit)
RP2	= AC Loss Restore (2nd digit)
FD	= Fire Drill (1st digit)
FD2	= Fire Drill (2nd digit)
RFD	= Fire Drill Restore (1st digit)
RFD2	= Fire Drill Restore (2nd digit)
V	= Supervisory Condition (1st digit)
V2	= Supervisory Condition (2nd digit)
RV	= Supervisory Condition Restore (1st digit)
RV2	= Supervisory Condition Restore (2nd digit)
X	= Test Report (1st digit)
X2	= Test Report (2nd digit)
Y	= A trouble corresponding to the following:
7	= Ground Fault
8	= Low Battery
9	= not used
A	= Telco Primary Line Fault
B	= Telco Secondary Line Fault
C	= Main Bell Fault, Annunciator Bell
D	= Communication Fault to Primary Number
E	= Communication Fault to Secondary Number
F	= System Off Normal Fault/System Fault (Slave Operation, see Chapter 6)
UD	= Upload/download (1st digit)
UD2	= Upload/download (2nd digit)

Table 5.2 Format Selection Address Explanation

NOTE: For Expanded Reporting, the control panel automatically adds the digit corresponding to the zone number and the second digit corresponding to any system trouble condition. Only the first digit is programmable.

5.1 Transmittal Priorities

The integral communicator transmits highest priority events first. Events, in terms of priority, are listed below in descending order:

1. Alarms (highest priority level)
 - ✓ Pull stations
 - ✓ Waterflow
 - ✓ Smoke detector
 - ✓ Other alarm types
2. Supervisory Zone
3. System Troubles
 - ✓ Zone disabled
 - ✓ Fire drill
 - ✓ AC fail (after delay)
 - ✓ Zonal faults
 - ✓ Earth fault
 - ✓ Low battery
 - ✓ Telephone line fault
 - ✓ Notification Appliance Circuits fault
 - ✓ Communication trouble
 - ✓ Annunciator trouble
 - ✓ System off normal
4. Restoral Reports
 - ✓ Zone alarm
 - ✓ Supervisory
 - ✓ Zone(s) enabled
 - ✓ Fire drill
 - ✓ AC
 - ✓ Zone fault
 - ✓ Earth
 - ✓ Battery
 - ✓ Telephone line
 - ✓ Notification Appliance Circuits
 - ✓ Communication
 - ✓ Annunciator trouble
 - ✓ System off normal
5. 24 Hour Test (lowest priority)

Red LEDs are provided on the circuit board to identify which telephone line is activated. Also, a green LED labeled *Kissoff* will turn on whenever the control panel has successfully transmitted reports to the Central Station. The *Kissoff* LED may turn on several times during communications with a Central Station.

The table below shows UL listed receivers which are compatible with the MS-9050UD.

Format	FBI CP220FB (1)	Ademco 685 (2)	Silent Knight 9000 (3)	Silent Knight 9800 (4)	Osborne Hoffman 2000E (5)	Radionics 6600 (6)	Surgard System III(7)	Surgard MLR-2(8)	Surgard MR-2000(9)	Ademco MX8000(10)
4+1 Ademco Express	✓	✓		✓	✓	✓	✓	✓	✓	✓
4+2 Ademco Express	✓	✓		✓	✓	✓	✓	✓	✓	✓
3+1/Standard/1800/2300	✓	✓	✓	✓	✓				✓	✓
3+1/Expanded/1800/2300	✓	✓	✓	✓	✓				✓	✓
3+1/Standard/1900/1400	✓	✓	✓	✓	✓				✓	✓
3+1/Expanded/1900/1400	✓	✓	✓	✓	✓				✓	✓
4+1/Standard/1800/2300		✓	✓	✓	✓		✓	✓	✓	✓
4+1/Expanded/1800/2300		✓	✓	✓	✓		✓	✓	✓	✓
4+1/Standard/1900/1400		✓	✓	✓	✓		✓	✓	✓	✓
4+1/Expanded/1900/1400		✓	✓	✓	✓		✓	✓	✓	✓
4+2/Standard/1800/2300	✓	✓	✓	✓	✓	✓	✓	✓	✓	✓
4+2/Expanded/1800/2300	✓	✓	✓	✓	✓	✓	✓	✓	✓	✓
4+2/Standard/1900/1400	✓	✓	✓	✓	✓	✓	✓	✓	✓	✓
4+2/Expanded/1900/1400	✓	✓	✓	✓	✓	✓	✓	✓	✓	✓
Ademco Contact ID	✓	✓		✓	✓	✓	✓	✓	✓	✓
Not Used										

Table 5.3 Compatible UL Listed Receivers

1. With version 3.9 software
2. With 685-8 Line Card with Rev. 4.4d software
3. With 9002 Line Card Rev. 9035 software or 9032 Line Card with 9326A software
4. With 124077V2.00 Receiver and 126047 Line Card Rev. M
5. With V.7301 Receiver S/W
6. With 01.01.03 Receiver S/W and Line Card 01.01.03
7. Surgard System III software version 1.6
8. Surgard MLR-2 software version 1.86
9. With DSP4016 and V1.6 Line Card
10. With 124060V206B and 124063 Line Card Rev. B

IMPORTANT! It is the installer’s responsibility to ensure that the Digital Alarm Communicator/Transmitter is compatible with the Central Station Receiver, utilized by the monitoring service, prior to installation. The Compatibility Table provides a list of compatible receivers and associated software versions for the receivers. Changes in the hardware and/or software by the receiver manufacturers may affect the receiver compatibility with the FACP DACT. After completing the installation, communication between the DACT and Central Station Receiver must be tested and verified.

Section 6: Local/Remote Site Upload/Download

The control panel may be programmed or interrogated off-site via the public switched telephone network. Any personal computer with Windows® XP or greater, with a 2400 baud compatible modem and Fire-Lite Upload/Download software kit P/N PK-CD, may serve as a Service Terminal. This allows download of the entire program or upload of the entire program, history file, walktest data, current status, time and date.

The control panel may also communicate to a local PC at the job-site. The PC must be connected to TB3 as shown on page 10, using cable P/N: PRT/PK-CABLE.

Important: *Remote modification of FACP programming requires that the panel be enabled for remote download (refer to “Remote Download” on page 177). Remote interrogation of panel programming, history logs, detector status, etc., is possible without enabling the remote download option.*

CAUTION: To prevent the 'request for upload/download' message(s) from being reported to the Central Station(s), make certain to disable all upload/download reports back to both Central Stations (refer to “Central Station” on page 122).

After the downloading process, the fire protection may be inactive for up to 2 minutes while the fire panel re-initializes.

After successfully downloading a program, make certain to perform the following steps:

1. Review all programmed entries and compare to intended program data
2. Test all affected panel operations
3. Immediately correct any problems found

6.1 Remote Download

NFPA 72 requirements state that a technician must be on-site and at the control panel whenever the PS-Tools programming utility is used to download any information to the FACP. For this reason, a new option has been added to the FACP which allows an individual at the FACP to enter a password and either enable the proprietary mode where downloading will be allowed at any time or access a specific password protected screen where downloading will be allowed regardless of the current proprietary setting. The Remote Download option can be selected from the main menu screen as shown below:

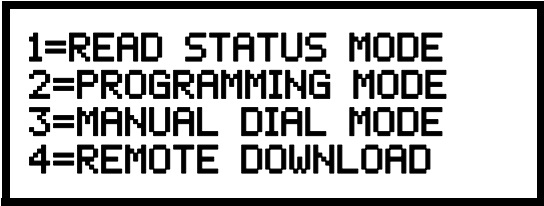

```
1=READ STATUS MODE
2=PROGRAMMING MODE
3=MANUAL DIAL MODE
4=REMOTE DOWNLOAD
```

Pressing 4 for Remote Download while viewing the main menu will cause the following screen to be displayed:



```
REMOTE DOWNLOAD
ENTER PASSWORD
*****
```

The Remote Download password (default 00000) must be entered to access the Remote Download feature. Note that the default password can be changed using the Password Change option (refer to “Password Change” on page 136). Entering the correct password will cause the following screen to be displayed:



```
REMOTE DOWNLOAD
1=PROPRIETARY      NO
2=ACCEPT DOWNLOAD
```

Pressing 1 for *Proprietary No* (factory default setting), while viewing the Remote Download screen, will cause the display to toggle from *Proprietary No* to *Proprietary Yes*. Each press of the 1 key will cause the display to toggle between *Proprietary No* and *Proprietary Yes*. Selecting *Proprietary Yes* will program the FACP to allow remote programming downloads from the PS-Tools programming utility at all times without the need to access the Remote Download screen.

Pressing 2 for *Accept Download* will cause the following screen to be displayed:



```
*ALLOWING DOWNLOADS*
IF YOU EXIT THIS
SCREEN DOWNLOADS
WILL BE DISABLED!
```

While this screen is displayed, remote programming downloads are allowed regardless of the Proprietary setting. Exiting this screen will disable any further downloads to the FACP. Also, following 30 minutes of inactivity (including up/downloading), the Accept Download screen will time-out, causing the display to return to the System All Normal screen.

6.2 Transferring a Program

The first time that the control panel is contacted, a secret code is loaded in by a Service Terminal. Future upload or download requests cause verification of the secret code by the control panel before processing of data is allowed. If the secret code is not verified, the control panel will terminate the request.

While the control panel is communicating with the remote Service Terminal, one of the DACT's red phone line active LEDs and the green *Kissoff* LED will remain on steady. These LEDs do not light for local (direct connect) programming.

In order to download to the panel, the following must be true:

- ✓ The control panel must be in the Normal Mode of operation. Downloading is not allowed if the panel is in any other mode.
- ✓ There cannot be any active communications ongoing with a Central Station receiver.
- ✓ All active events must be successfully 'kissed-off' by the Central Station(s). The communicator must be in a standby state with no new information waiting to be transmitted to a Central Station.

6.3 Security Features

Upload and download with the control panel have been carefully designed to include key security features to ensure proper functionality. Any time a transfer is initiated, the control panel and the Service Terminal will communicate and transfer data before contacting a Central Station. When the data transfers are completed and the control panel disconnects from the Service Terminal, the control panel will call the Central Station and report one of the following conditions:

- Upload/download request received
- Upload and/or download request successful
- Upload/download failed

The key features are listed and explained in the following sections.

Secret Code Verification

A secret code is stored in the control panel by a Service Terminal to prevent unauthorized access. The secret code is created at the Service Terminal by the master user and cannot be viewed or changed by anyone other than a master user. Viewing of the secret code is prohibited at the control panel. Prior to allowing an upload or download of data, the control panel will verify the secret code transmitted by the Service Terminal.

Time-out at Control Panel

Upon answering an incoming (modem) call on the primary Central Station phone line, the control panel will listen for a modem connection signal. If this signal is not received within 30 seconds, the control panel will disconnect the call. Upon successful connection (secret code verified), if no communication occurs within five minutes, the panel will disconnect the call.

Whether a PC is connected locally (at the job-site) or remotely (modem), 2 minutes of inactivity will result in an upload/download time-out. Upon time-out, transfer activity will be reported to the Central Station (if enabled) and the connection will be terminated.

Error Checking

As each block of data is received by the control panel, it is checked for accuracy. If an error is detected, the block is retransmitted until correct, up to a maximum of four times. If the Secret Code is not verified and four errors occur, the call is disconnected and the report that the upload/download was not successful is called to the Central Station(s).

Central Station Data Protection

The primary and secondary Central Station phone numbers, communications format, account code, test time and programmable event codes are vital Central Station information. These blocks of data are protected from partial programming due to faulty phone connections, line noise and other errors. This prevents the panel from being confused due to a wrong phone number, account code, test time and most critical formatting errors.

Section 7: Power Supply Calculations

7.1 Overview

This section contains instructions and tables for calculating power supply currents in alarm and standby conditions. This is a four-step process, consisting of the following:

1. Calculating the total amount of AC branch circuit current required to operate the system
2. Calculating the power supply load current for non-fire and fire alarm conditions and calculating the secondary (battery) load
3. Calculating the size of batteries required to support the system if an AC power loss occurs
4. Selecting the proper batteries for your system

7.2 Calculating the AC Branch Circuit

The control panel requires connection to a separate, dedicated AC branch circuit, which must be labeled **FIRE ALARM**. This branch circuit must connect to the line side of the main power feed of the protected premises. No other non-fire alarm equipment may be powered from the fire alarm branch circuit. The branch circuit wire must run continuously, without any disconnect devices, from the power source to the control panel. Overcurrent protection for this circuit must comply with Article 760 of the National Electrical Codes as well as local codes. Use 14 AWG (2.00 mm²) wire with 600 volt insulation for this branch circuit.

Use Table 7.1, to determine the total amount of current, in AC amperes (A), that must be supplied to the system.

Device Type	Number of Devices		Current Draw (AC amps)		Total Current per Device
MS-9050UD or MS-9050UDE	1	X	3.0 or 1.5	=	
	[]	X	[]	=	
Sum Column for AC Branch Current Required				=	

Table 7.1 AC Branch Circuit Requirements

7.3 Calculating the System Current Draw

7.3.1 Overview

The control panel must be able to power all internal and external devices continuously during the non-fire alarm condition. To calculate the non-fire alarm load on the system power supply when primary power is applied, use Calculation Column 1 in Table 7.3 on page 182. The control panel must support a larger load current during a fire alarm condition. To calculate the fire alarm load on the power supply, use Calculation Column 2 in Table 7.3 on page 182. The secondary power source (batteries) must be able to power the system during a primary power loss. To calculate the non-fire alarm load on the secondary power source, use Calculation Column 3 in Table 7.3 on page 182.

When calculating current draw and the battery size, note the following:

- ‘Primary’ refers to the main power source for the control panel
- ‘Secondary’ refers to the control panel’s backup batteries
- All currents are given in amperes (A). Table 7.2 shows how to convert milliamperes and microamperes to full amperes.

To convert...	Multiply	Example
Milliamperes (mA) to amperes (A)	mA x 0.001	3 mA x 0.001 = 0.003A
Microamperes (µA) to amperes (A)	µA x 0.000001	300 µA x 0.000001 = 0.0003 A

Table 7.2 Converting to Full Amperes

7.3.2 How to Use Table 7.3 on page 182 to Calculate System Current Draw

Use Table 7.3 on page 182 to calculate current draws as follows:

1. Enter the quantity of devices in all three columns.
2. Enter the current draw where required. Refer to the Fire-Lite Device Compatibility Document for compatible devices and their current draw.
3. Calculate the current draws for each in all columns.
4. Sum the total current for each column.
5. Copy the totals from Column 2 and Column 3 to Table 7.4 on page 183.

Following are the types of current that can be entered into Table 7.3 on page 182:

- ✓ **Calculation Column 1** - The primary supply current load that the control panel must support during a non-fire alarm condition, with AC power applied
- ✓ **Calculation Column 2** - The primary supply current load that the control panel must support during a fire alarm condition, with AC power applied
- ✓ **Calculation Column 3** - The standby current drawn from the batteries in a non-fire alarm condition during a loss of AC power

Table 7.3 contains columns for calculating current draws. For each column, calculate the current and enter the total (in amperes) in the bottom row. When finished, copy the totals from Calculation Column 2 and Calculation Column 3 to Table 7.4 on page 183.

Device Type	Calculation Column 1 Primary, Non-Fire Alarm Current (amps)			Calculation Column 2 Primary, Fire Alarm Current (amps)			Calculation Column 3 Secondary, Non-Fire Alarm Current (amps)		
	Qty	X [current draw] =	Total	Qty	X [current draw] =	Total	Qty	X [current draw] =	Total
Main Circuit Board	1	X[0.120]=	0.120	1	X[0.200]=	0.200	1	X[0.120]=	0.120
4XTMF	[]	X[0.005]=		[]	X[0.011] ¹ =		[]	X[0.005]=	
ANN-SEC Card	1 max	X[0.003]=		1 max	X[0.003]=		1 max	X[0.003]=	
4-wire Detector Heads	[]	X[] ² =		[]	X[]=		[]	X[]=	
Power Supervision Relays ³	[]	X[0.025]=		[]	X[0.025]=		[]	X[0.025]=	
CP350 & CP355	[]	X[0.00030]=		maximum alarm draw for all devices	0.400	[]	X[0.00030]=		
SD350 & SD355	[]	X[0.00030]=	[]			X[0.00030]=			
SD350T & SD355T	[]	X[0.00030]=	[]			X[0.00030]=			
AD350 & AD355	[]	X[0.00030]=	[]			X[0.00030]=			
H350 & H355	[]	X[0.00030]=	[]			X[0.00030]=			
H350R & H355R	[]	X[0.00030]=	[]			X[0.00030]=			
H355HT	[]	X[0.00030]=	[]			X[0.00030]=			
D355PL	[]	X[0.00030]=	[]			X[0.00030]=			
B200SR ⁴	[]	X[0.0005]=	[]			X[0.001]=			
B224RB Relay Base	[]	X[0.00050]=	[]			X[0.00050]=			
B224BI Isolator Base	[]	X[0.00045]=	[]			X[0.00045]=			
MMF-300	[]	X[0.00050]=	[]			X[0.00040]=			
MMF-300-10	[]	X[0.00350]=	[]			X[0.00350]=			
MDF-300	[]	X[0.00075]=	[]			X[0.00075]=			
MMF-301	[]	X[0.000375]=	[]			X[0.000375]=			
MMF-302	[]	X[0.00027]=	[]			X[0.00027]=			
MMF-302-6	[]	X[0.00200]=	[]			X[0.00200]=			
BG-12LX	[]	X[0.00023]=	[]			X[0.00023]=			
CMF-300	[]	X[0.00039]=	[]			X[0.00039]=			
CMF-300-6	[]	X[0.00225]=	[]			X[0.00225]=			
CRF-300	[]	X[0.00027]=	[]	X[0.00027]=					
CRF-300-6	[]	X[0.00145]=	[]	X[0.00145]=					
I300	[]	X[0.00040]=	[]	X[0.00040]=					
ANN-80(C)	[]	X[0.0370]=	[]	X[0.0400]=	[]	X[0.0150]=			
ANN-I/O	[]	X[0.0350]=	[]	X[0.2000]=	[]	X[0.0350]=			
ANN-RLY	[]	X[0.0150]=	[]	X[0.0750]=	[]	X[0.0150]=			
ANN-(R)LED	[]	X[0.0280]=	[]	X[0.0680]=	[]	X[0.0280]=			
ANN-S/PG	[]	X[0.0450]=	[]	X[0.0450]=	[]	X[0.0450]=			
NAC #1			[]	X[]=					
NAC #2			[]	X[]=					
Sum each column⁵ for totals	Primary Non-Alarm =			Primary Alarm =			Secondary Non-Alarm =		

Table 7.3 System Current Draw Calculations

- 1 If using the Reverse Polarity Alarm output, add 0.005 amps; if using the Reverse Polarity Trouble output, add another 0.005 amps.
- 2 Refer to the Device Compatibility Document for standby current.
- 3 Must use compatible listed Power Supervision Relay.
- 4 Maximum alarm current for each sounder base is 0.035 amps which must be supplied by aux. 24VDC source.
- 5 Total current draw listed above cannot exceed 2.7 amps.

7.4 Calculating the Battery Size

Use Table 7.4 to calculate the total Standby and Alarm load in ampere hours (AH). This total load determines the battery size (in AH), required to support the control panel under the loss of AC power. Complete Table 7.4 as follows:

1. Enter the totals from Table 7.3 on page 182, Calculation Columns 2 and 3 where shown.
2. Enter the NFPA Standby and Alarm times (refer to 'NFPA Requirements' below).
3. Calculate the ampere hours for Standby and Alarm, then sum the Standby and Alarm ampere hours.
4. Multiply the sum by the derating factor of 1.2 to calculate the proper battery size (in AH).
5. Write the ampere hour requirements on the Protected Premises label located inside the cabinet door.

Secondary Standby Load (total from Table 7.3 Calculation Column 3) []	Required Standby Time (24 hours) X []	= AH
Primary Alarm Load (total from Table 7.3 Calculation Column 2) []	Required Alarm Time (for 5 min., enter 0.084, for 10 min., enter 0.168) X []	= AH
Sum of Standby and Alarm Ampere Hours		= AH
Multiply by the Derating Factor		X 1.2
Battery Size, Total Ampere Hours Required		= AH

Table 7.4 Total Secondary Power Requirements at 24 VDC

7.4.1 NFPA Battery Requirements

- NFPA 72 Local and Proprietary Fire Alarm Systems require 24 hours of standby power followed by 5 minutes in alarm.
- NFPA 72 Central, Auxiliary and Remote Station Fire Alarm Systems require 60 hours of standby followed by 5 minutes in alarm. Batteries installed in a system powered by a generator need to provide at least 4 hours of standby power.

7.4.2 Selecting and Locating Batteries

Select batteries that meet or exceed the total ampere hours calculated in Table 7.4. The control panel can charge batteries in the 7 AH to 18 AH range. The control panel cabinet is capable of housing batteries up to 18 AH. Batteries larger than 18 AH require a UL listed external battery charger and cabinet such as the BB-26, BB-55F, or other UL-listed external battery cabinet.

Appendix A: Software Zones

A.1 Correlations

Setup and configuration of an addressable system is different than a conventional system. In a conventional system, assignment of input devices (smoke detectors, pull stations, heat detectors, etc.) to zones is accomplished through wiring. The wiring is direct from clearly marked panel terminals to any device assigned to a particular zone. Connection of output devices (horns, bells, strobes, etc.) in a conventional system is accomplished by direct wiring of the output devices to Notification Appliance Circuit terminals.

In an addressable system, a minimum of a single pair of wires (SLC communication loop) is used to connect all addressable input and output devices. Communications between the FACP (Fire Alarm Control Panel) and all addressable devices takes place over the wire pair which originates from the FACP. Software programming is used to configure the system as opposed to direct wiring. Zone assignments are created via software means, hence the term *software zones*.

Setup of an MS-9050UD software zone is accomplished by panel programming. Each addressable device can be assigned to a maximum of five software zones. Each software zone, however, may have from 1 to 50 addressable input and output devices assigned to it.

Monitor modules, control modules and detectors comprise a group of 50 addresses, each device having a unique address from 1 to 50. Be careful not to duplicate addresses between devices. Refer to the following page for an example of zoning.

In the example on the following page:

- Zone 01 has the following addressable devices assigned to it:
 - ✓ SD355 smoke detectors with addresses *01* and *02*
 - ✓ MMF-300 monitor module with address *03*
 - ✓ MMF-302 monitor module with address *04* and *05*
 - ✓ CMF-300 control modules with addresses *06*, *07*, *10*, *11*, and *13*
- Zone 02 has the following addressable devices assigned to it:
 - ✓ MMF-302 monitor module with addresses *04* and *05*
 - ✓ CP355 smoke detectors with addresses *15* and *16*
 - ✓ CMF-300 control modules with addresses *20*, *11*, and *21*
- Zone 03 has the following addressable devices assigned to it:
 - ✓ SD355 smoke detectors with addresses *22*, *24*, and *25*
 - ✓ MMF-302 control module with address *30*
 - ✓ CMF-300 control modules with addresses *11*, *31*, and *32*

The example points out some of the key assignment features of the MS-9050UD. Addresses of detectors, monitor modules and control modules are not duplicated. The control module with address 11 is assigned to three software zones (providing floor above and floor below). Be careful to properly plan the installation prior to installing any devices.

Correlation of Input and Output Zones

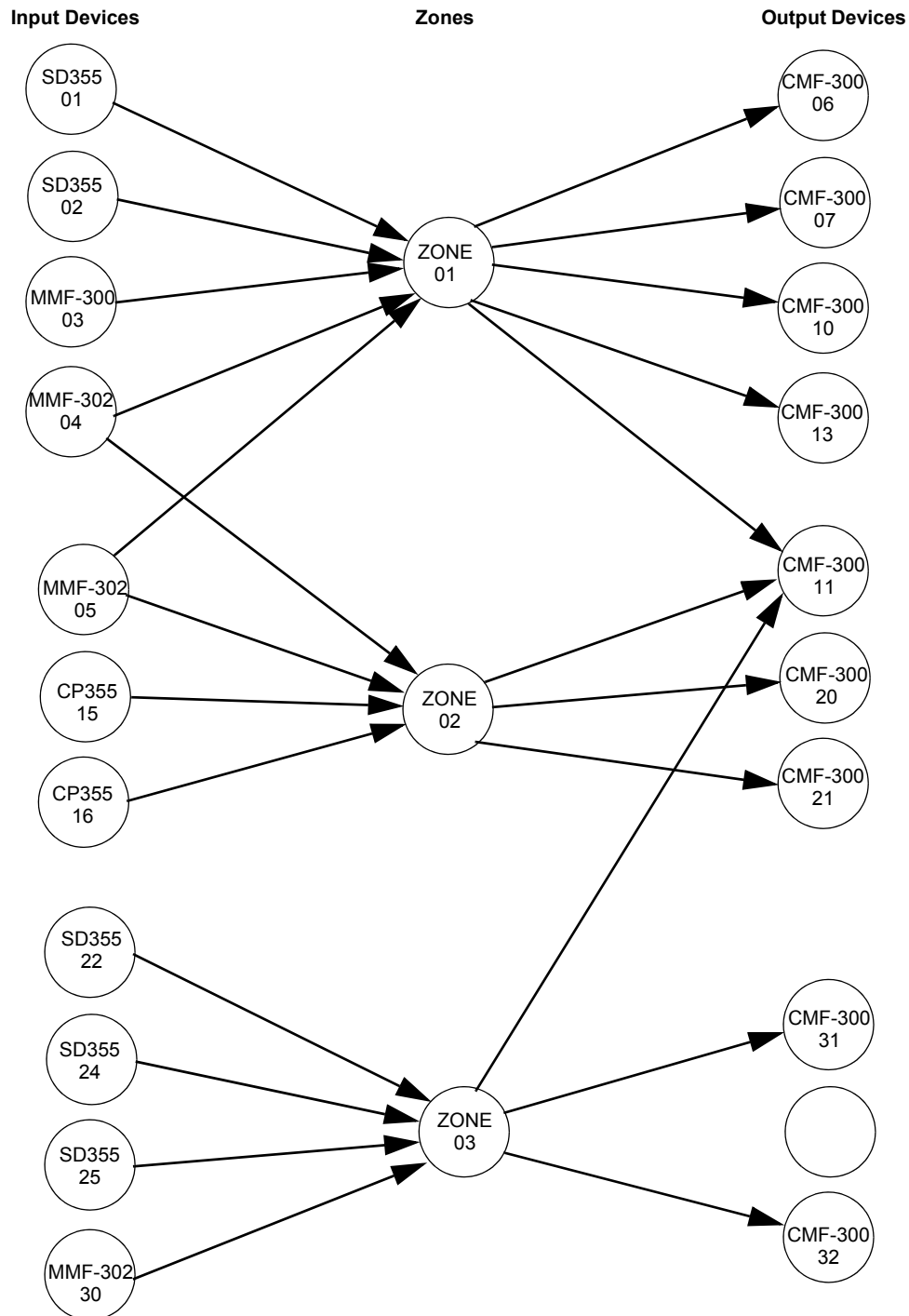

The zone correlations which are shown graphically above are also presented in Table A.1 on page 186.

ADDRESSABLE DEVICE ZONE ASSIGNMENT			
Address	Device Type	Zone Number	ADJ/NOUN
01	SD355	1	FIRST HALL
02	SD355	1	ELEV. LOBBY
03	MMF-300	1	
04	MMF-302	1, 2	
05	MMF-300	1, 2	
06	CMF-300	1	
07	CMF-300	1	
08			
09			
10	CMF-300	1	
11	CMF-300	1, 2, 3	
12			
13	CMF-300	1	
14			
15	CP355	2	2ND FLOOR
16	CP355	2	ROOM 210
17			
18			
19			
20	CMF-300	2	
21	CMF-300	2	
22	SD355	3	3RD FLOOR
23			
24	SD355	3	MEZZANINE
25	SD355	3	MECH. ROOM
26			
27			
28			
29			
30	MMF-302	3	
31	CMF-300	3	
32	CMF-300	3	
33			
34			
35			
36			
37			
38			
39			
40			
41			
42			
43			
44			
45			
46			
47			
48			
49			
50			

Table A.1 Detector Programming Sheet Example

ADDRESSABLE DEVICE ZONE ASSIGNMENTS			
Address	Device Type	Zone Number	ADJ/NOUN
01			
02			
03			
04			
05			
06			
07			
08			
09			
10			
11			
12			
13			
14			
15			
16			
17			
18			
19			
20			
21			
22			
23			
24			
25			
26			
27			
28			
29			
30			
31			
32			
33			
34			
35			
36			
37			
38			
39			
40			
41			
42			
43			
44			
45			
46			
47			
48			
49			
50			

Table A.2 Blank Programming Sheet

ADDRESSABLE DEVICE ZONE ASSIGNMENTS			
Address	Device Type	Zone Number	ADJ/NOUN
01			
02			
03			
04			
05			
06			
07			
08			
09			
10			
11			
12			
13			
14			
15			
16			
17			
18			
19			
20			
21			
22			
23			
24			
25			
26			
27			
28			
29			
30			
31			
32			
33			
34			
35			
36			
37			
38			
39			
40			
41			
42			
43			
44			
45			
46			
47			
48			
49			
50			

Table A.3 Blank Programming Sheet

Appendix B: Default Programming

The following table provides a list of the programming options and their factory default settings.

Program Option	Factory Default	Program Option	Factory Default
Master Password	00000	NAC 1 & 2 Enable	Enabled
Maintenance Password	11111	NAC 1 & 2 Silenceable	Yes
Detector Programming	Not Installed	NAC 1 & 2 Type	Bell
Detector Type	Smoke-Photo	NAC 1 & 2 Sync Type	System Sensor
Detector Verification	Off	NAC 1 & 2 Autosilence	0
Detector Walktest	Yes	NAC 1 & 2 Coding	Steady
Detector PAS	No	NAC 1 & 2 Zones	Zone 000 only
Detector Presignal	No	NAC 1 & 2 Silence Inhibit	No
Detector Zone Assign.	000 only	Relay 1	Alarm
Detector Adj/Noun	none	Relay 2	Trouble (fixed)
Module Programming	Not Installed	Relay 3	Supervisory
Module Type	Monitor	Trouble Call Limit	0
Module Walktest	Yes	ANN-BUS Enabled	No
(not used)		Onboard DACT Enabled	No
Module Presignal	No	Ring Count	0
Module Zone Assign.	000 only	Central Station Reporting	Disabled
Module Adj/Noun	none	DACT Backup Reporting	First Available
Zone 0 Enable	Enabled	DACT Report Style	By Point
Zone 1 Enable	Enabled	Central Station 1 & 2 Account Code	0000
Zone 2 Enable	Enabled	Central Station 1 & 2 Test Time	0000
Zone 3 Enable	Enabled	Central Station 1 & 2 Test Time Interval	24 Hour
.....through.....	Central Station 1 & 2 Phone Number	
Zone 19 Enable	Enabled	Central Station 1 & 2 Format	Ademco Contact ID
Zone 0 Type	Monitor	Line 1 Touchtone/Rotary	Touchtone
.....through.....		Line 2 Touchtone/Rotary	Touchtone
Zone 19 Type	Monitor	Supervise Phone Line 2	Yes
Special Purpose Zones 17, 18, 19	No	ANN-BUS Enabled	No
Loop Style	Style 4	ANN-S/PG Port	Parallel
Loop Protocol	CLIP (fixed)	ANN-S/PG Baud	9600
Trouble Reminder	Off	ANN-S/PG Data Bits	7
Banner		ANN-S/PG Parity	Even
Time Format	12 Hr	ANN-S/PG Stop Bits	1
Hours Setting	12	ANN-S/PG Offline Timer	60
Minutes Setting	00	ANN-S/PG Printer Supervision	No
AM-PM Setting	AM	ANN-80 Piezo Enabled	Yes
Month Setting	01	ANN-80 Lock Enabled	Yes
Day Setting	01	ANN-80 Acknowledge Button Enabled	Yes
Year Setting	06	ANN-80 Silence Button Enabled	Yes
Canadian Option	Off	ANN-80 Reset Button Enabled	Yes
AC Loss Delay	2 Hours	ANN-80 Drill Button Enabled	Yes
Daylight Savings	Enabled	ANN-I/O Point/Zone	Zone

Month Start Daylight Savings	March	ANN-I/O Range	00-19
Week Start Daylight Savings	Week 2	ANN-I/O Active LEDs Only	
Month End Daylight Savings	November	ANN-RLY Relay 1	Zone 1
Week End Daylight	Week 1through.....
Verification	OFF	ANN-RLY Relay 10	Zone 10
Waterflow Silenceable	No	ANN-LED Point/Zone	Zone
PAS Timer	0	ANN-LED Alarms/ATS (Alarm, Trbl, Supv)	ATS
Presignal Timer	0	ANN-LED Range	0 - 9
Waterflow Retard Timer	0		

Appendix C: NFPA Standard-Specific Requirements

The MS-9050UD has been designed for use in commercial, industrial and institutional applications and meets the requirements for service under the National Fire Protection Association (NFPA) Standards outlined in this Appendix. The minimum system components required for compliance with the appropriate NFPA standard are listed below:

MS-9050UD Control Panel

Contains the main control board, cabinet (backbox and door), main power supply transformer and power supply.

Batteries

Refer to “Power Supply Calculations” on page 180, for Standby Power Requirements.

Initiating Devices

Connected to one of the control panel's Initiating Device Circuits

Notification Appliances

Connected to the control panel's Notification Appliance Circuits via a control module.

The additional equipment listed below is needed for compliance with the NFPA 72 standards:

NFPA 72 NATIONAL FIRE ALARM STANDARDS FOR:

NFPA 72 Central Station Service (Protected Premises Unit) or Remote Station Service

Onboard Digital Alarm Communicator Transmitter for connection to a compatible listed Central Station DACR or Protected Premises Receiving Unit. This unit must be installed as outlined in “Digital Alarm Communicator/Transmitter” on page 17.

OR

4XTMF Transmitter Module for connection to the Fire-Lite RS82 Remote Station Receiver. See Figure C.2, “Remote Station Connection Using 4XTMF Module,” on page 193, for installation instructions for this unit.

NFPA 72 Auxiliary Fire Alarm System

4XTMF Transmitter Module for connection to a compatible listed Local Energy Municipal Box. This unit must be installed as illustrated in the section titled “4XTMF Transmitter Module Installation” on page 33 and as outlined in Figure C.1, “Municipal Box Connected to 4XTMF Transmitter Module,” on page 192.

NFPA 72 Proprietary Fire Alarm System

MS-9050UD Alarm, Trouble and Supervisory contacts connected to Transmitter(s). See Figure C.3, “Proprietary Protective Signaling System,” on page 194, for installation instructions for this unit.

NFPA 72 Auxiliary Fire Alarm System

All connections are power-limited and supervised. This application is not suitable for separate transmission of sprinkler supervisory or trouble conditions.

Notes:

1. 3 ohms maximum loop resistance allowed for wiring from control panel to Municipal Box.
2. Cut JP28 on the MS-9050UD main circuit board to supervise placement of 4XTMF module and circuit.
3. Remove JP2 on the MS-9050UD main circuit board to enable FACP Supervisory relay.
4. Refer to “4XTMF Transmitter Module Installation” on page 33 for detailed information.

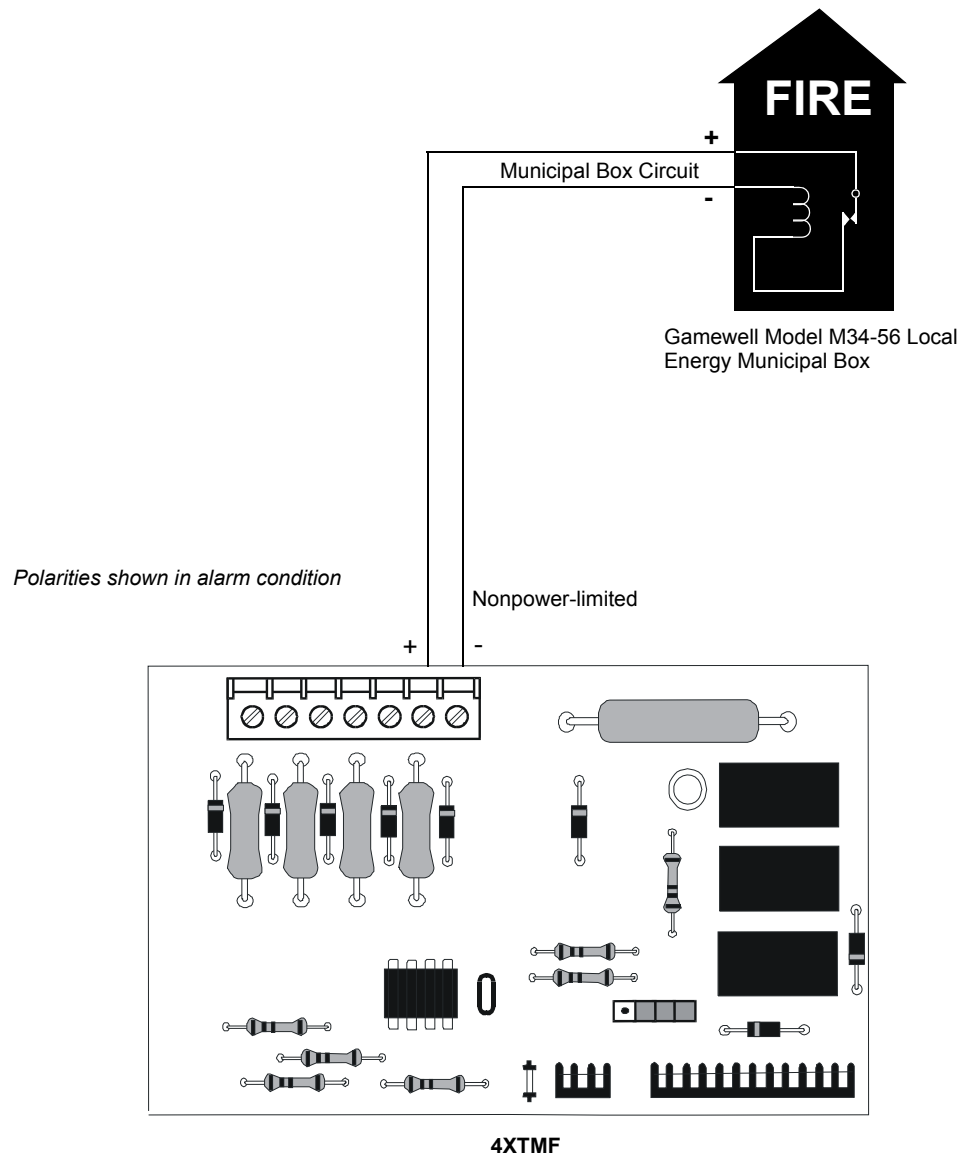

Figure C.1 Municipal Box Connected to 4XTMF Transmitter Module

NFPA 72 Remote Station Protective Signaling System

Notes:

1. Cut Jumper JP28 on the MS-9050UD main circuit board to supervise placement of the 4XTMF module.
2. Refer to “4XTMF Transmitter Module Installation” on page 33 for detailed information.

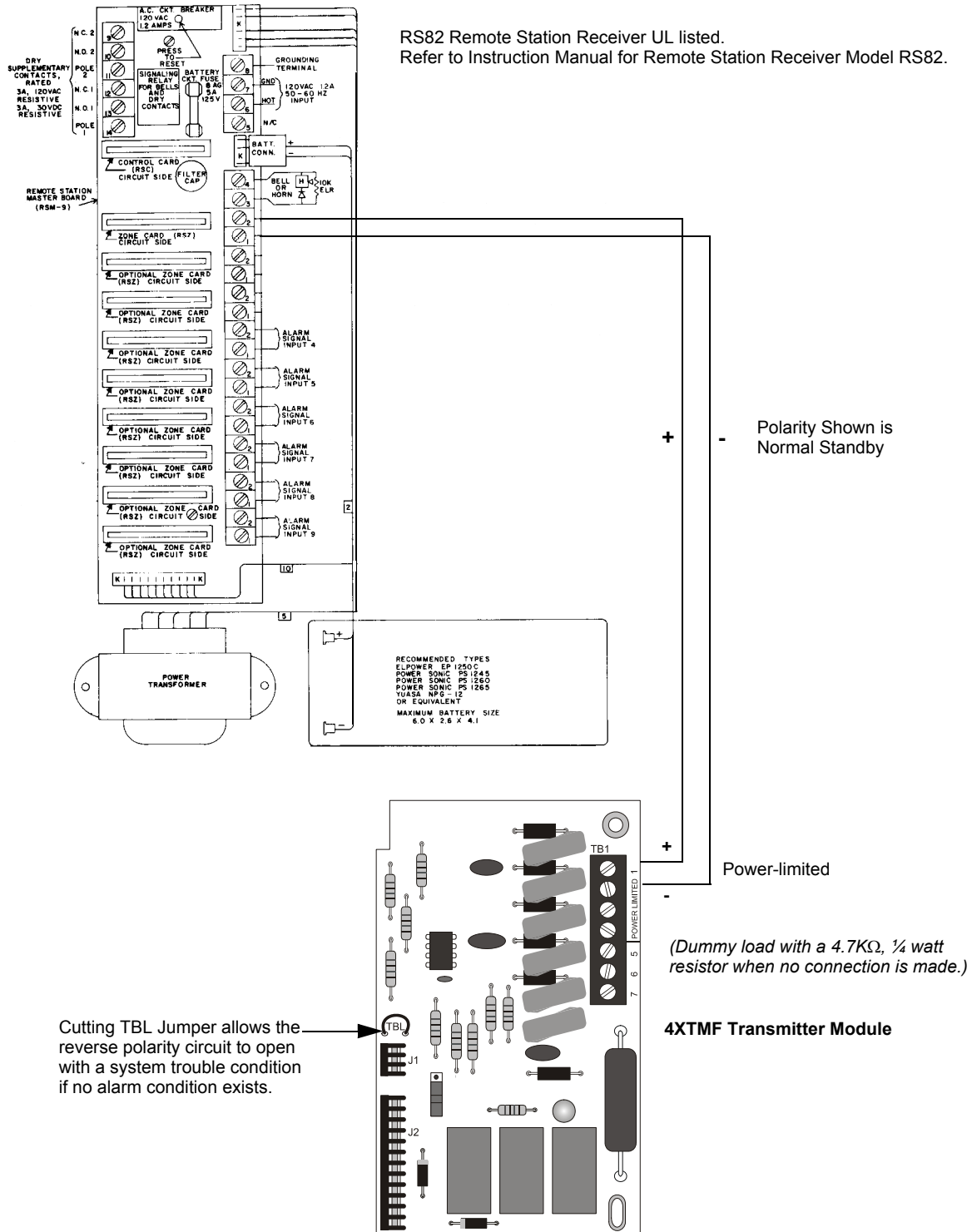

Figure C.2 Remote Station Connection Using 4XTMF Module

NFPA 72 Proprietary Protective Signaling Systems

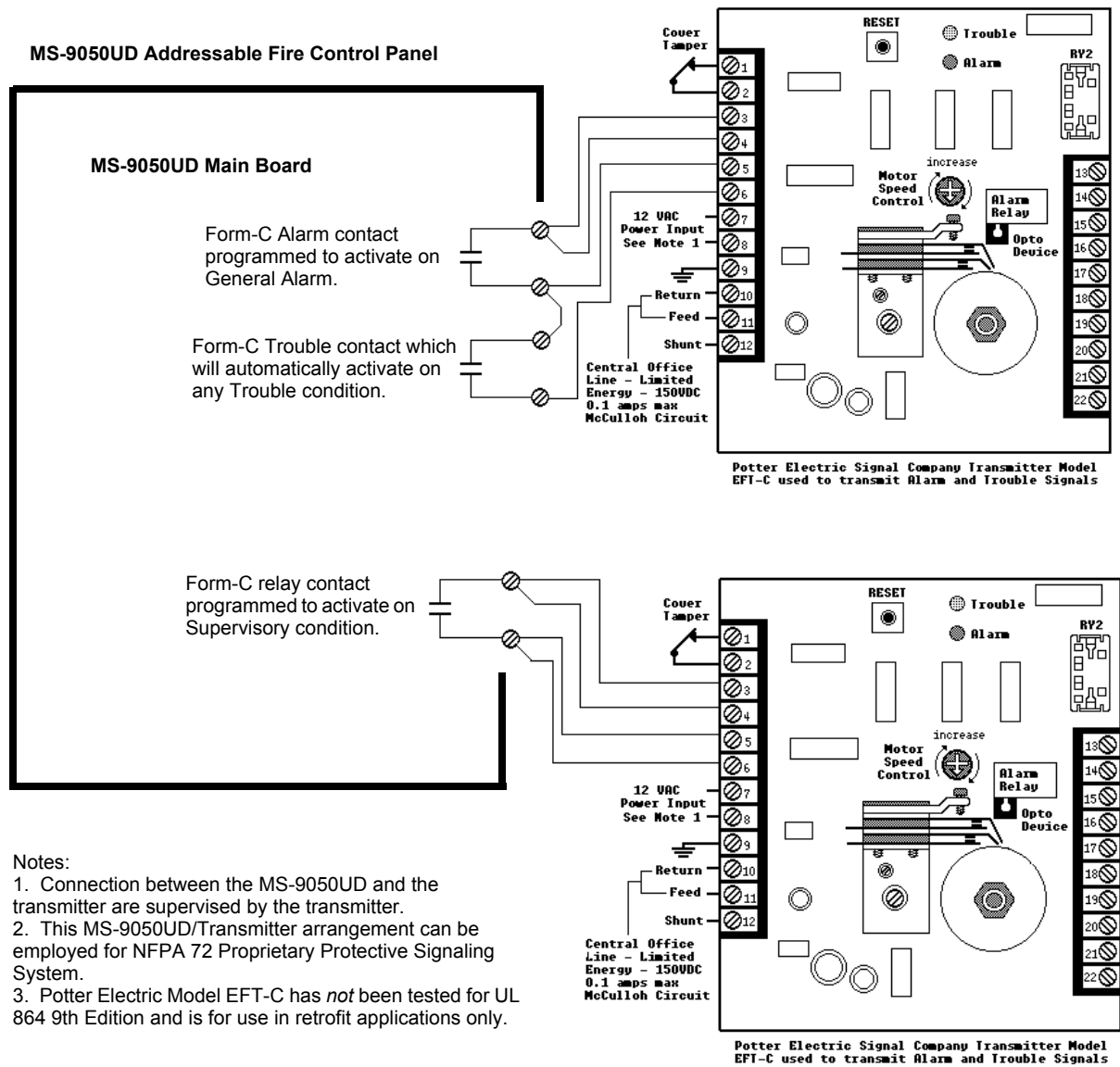

Figure C.3 Proprietary Protective Signaling System

C.1 Central Station/Remote Station Transmitter: Connection to FACP Dry Contacts

The dry contacts of the FACP programmable relays can be used to trip a UL-864 Listed Central Station/Remote Station Transmitter. The FACP contacts must be supervised by the Central Station/Remote Station Transmitter module using End-of-Line Resistors (ELRs) with a value determined by the Transmitter manufacturer. Power is also provided by the Central Station/Remote Station Transmitter manufacturer. Refer to the Central Station/Remote Station Transmitter manufacturer’s manual for details.

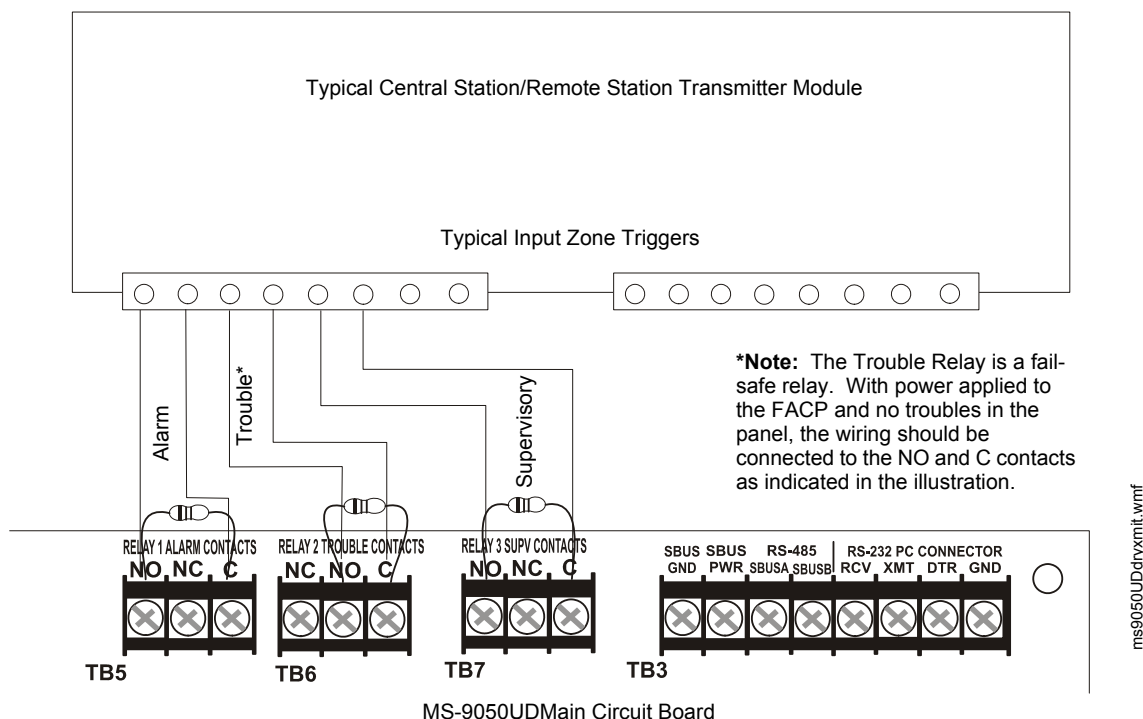

Figure C.4 FACP Dry Contacts Connection to Central Station/Remote Station Transmitter

C.2 MBT-1 Municipal Box Trip - Silenceable

The following figure illustrates the connection of the MBT-1 (Municipal Box Trip) between the FACP and a Local Energy Municipal Box. The use of an addressable control module programmed for *General Alarm* and *Silenceable* allows silencing of the Municipal Box without resetting the panel or box.

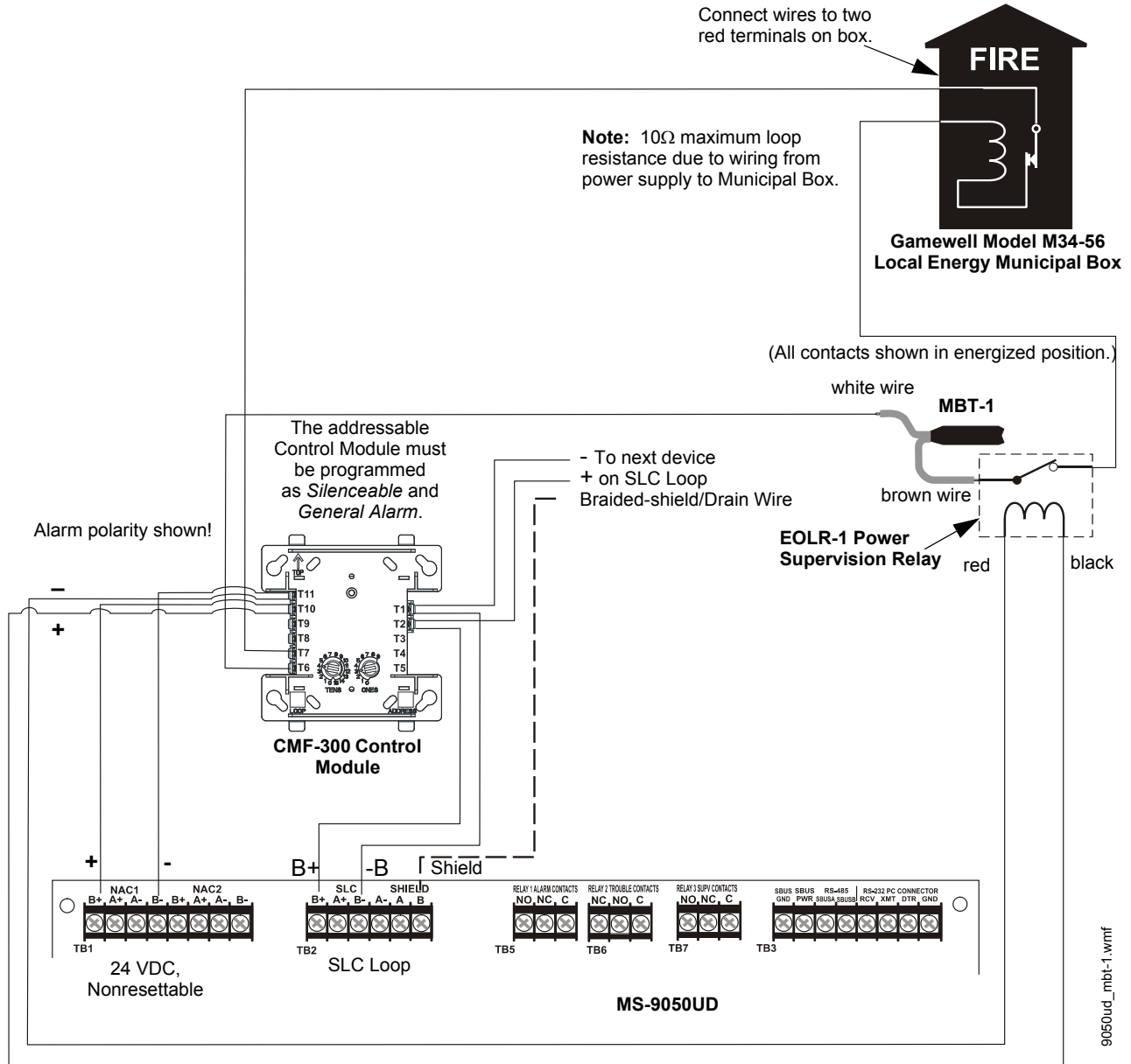

Figure C.5 MBT-1 Silenceable

Notes

Appendix D: FACP with Keltron

The following figure illustrates the connections between the FACP and Keltron Receiver/Transmitter.



CAUTION: POSSIBLE EQUIPMENT DAMAGE

FOR REASONS OF WIRING DIAGRAM CLARITY, TERMINAL DESIGNATIONS OF KELTRON MODULES ARE NOT SHOWN IN ACTUAL ORDER. FOLLOW KELTRON MANUAL AND MODULE MARKINGS FOR EXACT TERMINAL LOCATIONS TO PREVENT SEVERE MODULE DAMAGE!

IMPORTANT! All connections between the FACP and Keltron modules must be made within 20 feet and enclosed within conduit or equivalently protected against mechanical injury.

Keltron 95M3158 TTM-RPS

1. Terminals 7 and 8: Remote station alarm/trouble inputs.
2. Terminals 9 and 10: Sprinkler supervisory input.

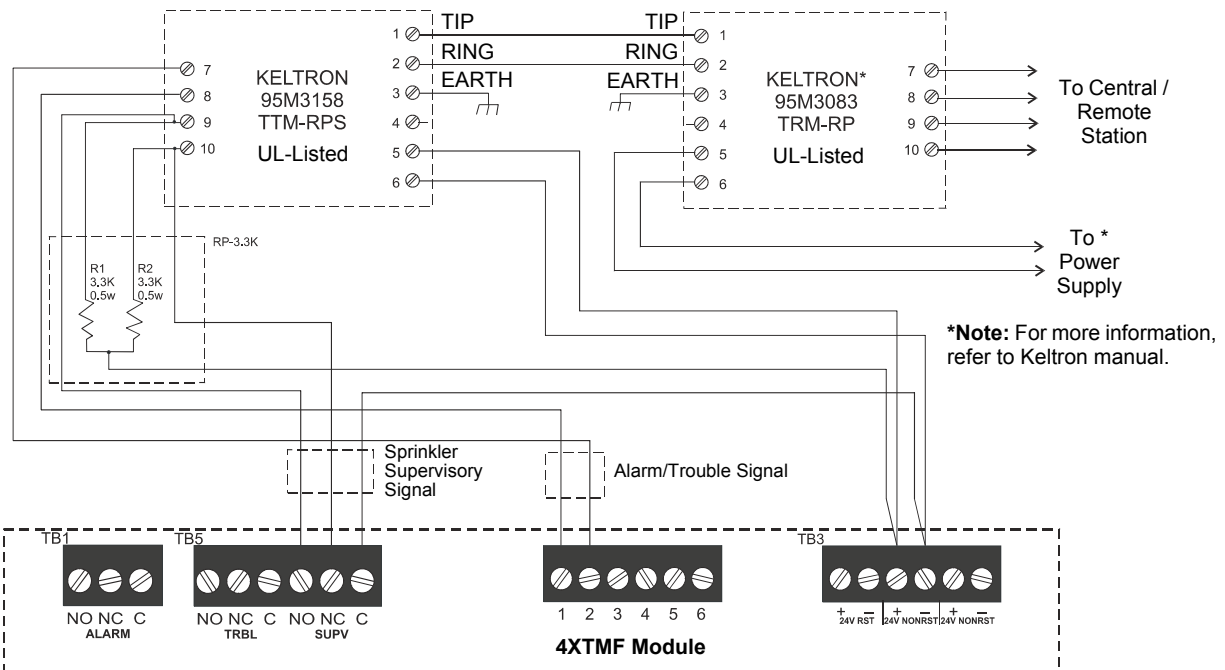

Note: Cut TBL jumper on 4XTMF module to send alarm/trouble signal from the same pair or terminals.

Fire Alarm Control Panel
(terminal blocks are not shown in their actual positions in order to clarify wiring connections)

Figure D.1 FACP With Keltron Wiring

Appendix E: Wire Requirements

T-tapping of the SLC loop wiring is allowed for 2-wire (Style 4) configurations. The total resistance of any branch cannot exceed 40 ohms. The total wire length of all branches cannot exceed 10,000 feet (3,000 m).

Connecting external system accessories to the MS-9050UD main circuits must be carefully considered to ensure proper operation. It is important to use the correct type of wire, wire gauge and wire run length for each MS-9050UD circuit. Reference the charts below to specify wire requirements and limitations for each MS-9050UD circuit.

SLC Loop Using Twisted, Unshielded Wire

While shielded wire is not required, it is recommended that all SLC wiring be twisted-pair to minimize the effects of electrical interference. Use the following table to determine the specific wiring requirements for the SLC when various wire is used.



NOTE: If the SLC loop is to be run in conduit with Notification Appliance Circuits, the risk of encountering problems can be greatly reduced by exclusively employing electronic sounders (such as MA/SS-24D) instead of more electronically noisy notification appliances such as electromechanical bells or horns

CIRCUIT CONNECTIONS		WIRE REQUIREMENTS		
Circuit Type	Circuit Function	Wire Type and Limitations	Recommended Max. Distance Feet (meters)	Wire Gauge and Compatible Brands
SLC loop (power-limited)	Connects to Addressable Devices	Twisted, shielded pair 40 ohms maximum per length of Style 6 and 7 loops. 40 ohms per branch maximum for Style 4 loops	10,000 (3,000 m) 8,000 (2,400 m) 4,875 (1,450 m) 3,225 (980 m)	12 AWG (3.25 mm ²): Genesis 4410, Signal 98230, Belden 9583, WPW999 14 AWG (2.00 mm ²): Genesis 4408 & 4608 Signal 98430, Belden 9581, WPW995 16 AWG (1.30 mm ²): Genesis 4406 & 4606 Signal 98630, Belden 9575, WPW991 <u>Direct Burial Cable</u> Isotec NP713110VNQ-S 18 AWG (0.75 mm ²): Genesis 4402 & 4602 Signal 98300, Belden 9574, WPW975 <u>Direct Burial Cable</u> Isotec NP714110VNQ-S
		Twisted, unshielded pair 40 ohms maximum per length of Style 6 and 7 loops. 40 ohms per branch maximum for Style 4 loops	10,000 (3,000 m) 8,000 (2,400 m) 4,875 (1,450 m) 3,225 (980 m)	12 AWG (3.25 mm ²): Belden 5020UL & 6020UL, Genesis WG-4315 & WG-4515 14 AWG (2.00 mm ²): Belden 5120UL & 6120UL, Genesis WG-4313 & WG-4513 16 AWG (1.30 mm ²): Belden 5220UL & 6220UL, Genesis WG-4311 & WG-4511 18 AWG (0.75 mm ²): Belden 5320UL & 6320UL, Genesis WG-4306 & WG-4506
		Untwisted, unshielded pair ¹	3,000 (900 m)	12-18 AWG (3.25 - 0.75 mm ²) using listed wire
ANN-BUS (EIA-485) (power-limited)	Connects to annunciator modules	Twisted pair with a characteristic impedance of 120 ohms or less	6,000 (1,800 m)	refer to Table 2.1, "Wiring Distances," on page 37.
EIA-232 (power-limited)	connects to PC computer	Twisted, shielded pair	50 (15 m)	18 AWG (0.75 mm ²) minimum
MMF-300 and MMF-301 (power-limited)	Initiating Device Circuit: Contact Closure	Maximum loop wire resistance is 1500 ohms	2,500 (760 m)	12-18 AWG (3.25 - 0.75 mm ²)
MMF-302 (power-limited)	Initiating Device Circuit: Two-wire Modules	No more than a 2.4 volt drop allowed at end of circuit. Maximum loop wire resistance is 25 ohms	2,500 (760 m)	12-18 AWG (3.25 - 0.75 mm ²)
CMF-300 (power-limited)	Notification Appliance Circuit	In alarm, no more than a 1.2 volt drop allowed at end of circuit	Distance limitation set by 1.2 volt maximum line drop	12-18 AWG (3.25 - 0.75 mm ²)

Table E.1 FACP Wire Specifications

1 When using untwisted, unshielded wire, full conduit is recommended for optimum EMI/RFI protection.

E.1 NAC Wiring

The following table lists NAC wiring requirements for the FACP.

NAC Load (Amps)	Max. allowable total loop resistance (ohms)	CLASS-B Max. allowable wire pair length (feet)				CLASS-A Max. allowable wire pair length (feet)			
		AWG 12 solid	AWG 14 solid	AWG 16 solid	AWG 18 solid	AWG 12 solid	AWG 14 solid	AWG 16 solid	AWG 18 solid
0.25	13.20	3420	2150	1350	849	1710	1075	675	425
0.5	6.60	1710	1075	675	425	855	537	337	212
0.75	4.40	1140	717	450	283	570	358	225	142
1	3.30	855	537	337	212	427	269	169	106
1.25	2.64	684	430	270	170	342	215	135	85
1.5	2.20	570	358	225	142	285	179	112	71
1.75	1.89	489	307	193	121	244	154	96	61
2	1.65	427	269	169	106	214	134	84	53
2.25	1.47	380	239	150	94	190	119	75	47
2.5	1.32	342	215	135	85	171	107	67	42

Table E.2 NAC Wiring Requirements for FACP

*Calculations are based on Direct-Current Resistance data for **uncoated copper wire**, per National Electrical Code (2005 Edition) Table 8, Conductor Properties.*

Appendix F: HVAC Control

The FACP can be programmed to shut down a building's HVAC fans in the event of a fire. The fans cannot be restarted until the fire alarm condition has been cleared and the FACP has been reset to a normal (non-alarm) condition.

IMPORTANT! *This HVAC feature is not to be used for smoke control. It is only designed to shut down fans during a fire alarm condition.*

F.1 Control Module Operation

F.1.1 HVAC SHUTDN

The **HVAC SHUTDN** type code can be assigned to any addressable control relay module for the purpose of shutting down HVAC fans during a fire alarm condition. Devices connected to a module with this type code are unsupervised. To program this feature in the FACP:

- Program the **HVAC SHUTDN** type code to the control relay module which will be used to shut down the fans (refer to *Type* under the section titled “Edit Module Screen for Control Modules” on page 78).
- Program the control relay module to a software zone and program alarm input devices which, when activated are to cause fan shutdown, to the same software zone (refer to *Zone Assignment* under the section titled “Edit Module Screen for Control Modules” on page 78).
- Monitor the control relay module using an addressable monitor module programmed for *Trouble Monitor*. The monitor module label should be programmed to indicate HVAC SHUTDOWN. When the control relay module is active (HVAC SHUTDN), the monitor module will indicate a trouble condition at the FACP and the display should indicate that the HVAC is shut down.

Once activated, the HVAC SHUTDN control module remains activated, even if the FACP is silenced or reset. After the alarm condition on the FACP has been cleared and the panel reset, the HVAC SHUTDN control relay module remains activated and the fans remain off. The monitor module programmed for *Trouble Monitor* which is being used to supervise the control relay module, will indicate a trouble condition at the control panel and the LCD should display that the HVAC is shut down. The fans can only be restarted when the HVAC SHUTDN control relay module is deactivated by the HVAC RESTART module.

F.2 Monitor Module Operation

F.2.1 HVAC RESTART

The **HVAC RESTART** type code can be assigned to any addressable monitor module for the purpose of resetting (deactivating) the HVAC SHUTDN control relay module and turning the fans back on. The **HVAC RESTART** monitor module acts globally throughout the FACP system and therefore is not programmed to a particular software zone. To program this feature in the FACP:

- Program the **HVAC RESTART** type code to the monitor module which will be used to deactivate the HVAC SHUTDN control relay module and restart the fans (refer to *Type Monitor* under the section titled “Edit Module Screen for Monitor Module” on page 69).

The HVAC RESTART monitor module does not latch when activated. Pressing a switch connected to the monitor module will deactivate the HVAC SHUTDN control relay module *only if there are no alarm conditions*. The HVAC SHUTDN control relay module can be deactivated if trouble conditions exist on the FACP.

F.2.2 HVAC OVERRIDE

The **HVAC OVERRIDE** type code can be assigned to any addressable monitor module for the purpose of overriding or preventing the HVAC SHUTDOWN control relay modules from activating. The **HVAC OVERRIDE** monitor module acts globally throughout the FACP system and therefore is not programmed to a particular software zone. To program this feature in the FACP:

- Program the **HVAC OVERRIDE** type code to the monitor module which will be used to override the HVAC SHUTDOWN control relay module and prevent the fans from turning off (refer to Type Monitor under the section titled “Edit Module Screen for Monitor Module” on page 69).

The HVAC OVERRIDE monitor module does not latch when activated. Activating a switch connected to the monitor module will override all HVAC SHUTDOWN control relay modules in the system, preventing the HVAC SHUTDOWN modules from activating and causing the FACP LCD to display an active HVAC OVERRIDE module and turn on the Supervisory LED. Releasing the switch will allow the HVAC SHUTDOWN control relay modules to activate with subsequent alarms, turning off the fans.

As an example, pressing the HVAC OVERRIDE switch with no alarms in the system will prevent the fans from being turned off when an alarm does occur. As long as the switch is activated, the fans will not shutdown for any alarms. If the system is still in alarm when the switch is released, the fans will not shutdown unless another alarm occurs after the switch is released.

Important! *If an alarm exists in the system and HVAC Shutdown has already occurred, HVAC OVERRIDE will have no effect on the HVAC SHUTDOWN control relay modules. HVAC OVERRIDE will prevent HVAC Shutdown from occurring only if it is initiated prior to an alarm condition.*



NOTE: Activation of the HVAC OVERRIDE module causes a supervisory event that will be communicated to the Central Station if enabled.

Appendix G: Ademco Contact ID Format Event Code Descriptions

This appendix describes the various Event Codes and their messages which are available for the Ademco Contact ID Format.

G.1 Transmission Format Between DACT and Receiver

The transmission string for the Ademco Contact ID Format is as follows:

SSSS 18 QXYZ GG CCC where

SSSS = Four digit Subscriber ID Account Code
 18 = Identifies transmission as Contact ID to the receiver at the Central Station
 Q = Event Qualifier where 1 = New Event and 3 = New Restore
 XYZ = Event code
 GG = Group number
 CCC = Zone/Point number

Notes:

1. **18**, which is used in the reporting structure to identify the transmission as Contact ID, is not printed out in the alarm and trouble report.
2. **GG** Group Number is fixed at '00' and cannot be changed.
3. **CCC** for Zone or Point Number:
 - ✓ Zone Number is transmitted as '00' for zone 0 up to '19' for zone 19
 - ✓ Point Number is transmitted as '01' for point/address 1 up to '50' for point/address 50

G.2 Ademco Contact ID Typical Printout

A typical printout from a Central Station receiver (such as the Ademco 685) of alarm and trouble reports in the Ademco Contact ID Reporting Structure follows:

<u>Time</u>	<u>Date</u>	<u>Rcvr/Line ID</u>	<u>SSSS</u>	<u>QXYZ</u>	<u>GG</u>	<u>CCCC</u>
11:28	03/25	11	7777	E110	00	C001 - general fire alarm on zone one
11:28	03/25	11	7777	E111	00	C002 - smoke detector alarm on zone two
11:28	03/25	11	7777	E380	00	C003 - fault on zone three
11:28	03/25	11	7777	E570	00	C009 - Zone nine disabled
11:28	03/25	11	7777	R110	00	C001 - Zone one alarm restored
11:28	03/25	11	7777	R111	00	C002 - smoke detector zone two restored
11:28	03/25	11	7777	R380	00	C003 - zone three fault restored
11:28	03/25	11	7777	R570	00	C009 - zone nine reenabled
11:28	03/25	11	7777	E158	00	C006 - high temperature, zone six
11:28	03/25	11	7777	E151	00	C007 - gas detected, zone seven

Notes:

1. **11** is an example of a Receiver/Line Card, showing which receiver and line card the message was transmitted to.
2. **Q**, which is the Event Qualifier for the reporting structure, is printed out in the report as an E for New Event or R for New Restore.

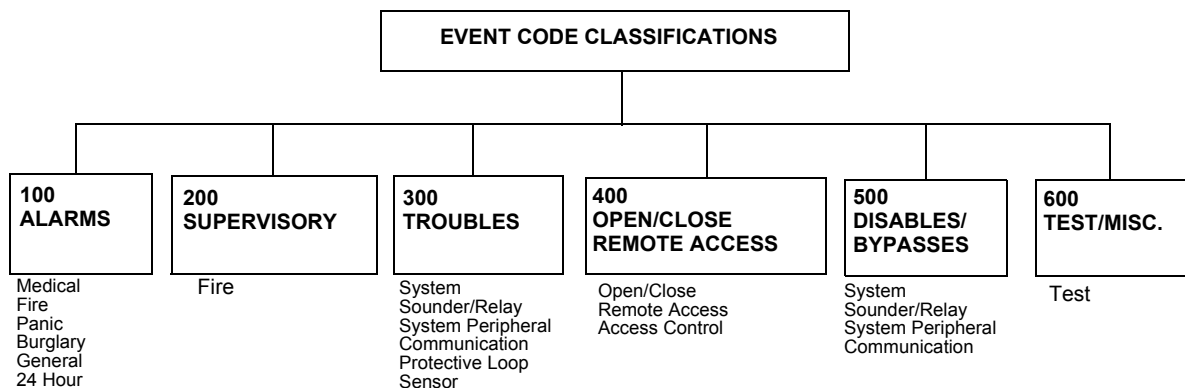

EVENT

MESSAGE

Medical Alarms - 100

- 100 Medical
- 101 Pendant Transmitter
- 102 Fail to report in

- EMERG - Personal Emergency - #
- EMERG - Personal Emergency - #
- EMERG - Fail to Check-in - #

Fire Alarms - 110

- 110 Fire Alarm
- 111 Smoke
- 112 Combustion
- 113 Waterflow
- 114 Heat
- 115 Pull Station
- 116 Duct
- 117 Flame
- 118 Near Alarm

- FIRE - Fire Alarm - #
- FIRE - Smoke Detector - #
- FIRE - Combustion - #
- FIRE - Waterflow - #
- FIRE - Heat Sensor - #
- FIRE - Pull Station - #
- FIRE - Duct Sensor - #
- FIRE - Flame Sensor - #
- FIRE - Near Alarm - #

Panic Alarms - 120

- 120 Panic Alarm
- 121 Duress
- 122 Silent
- 123 Audible

- PANIC - Panic - #
- PANIC - Duress - #
- PANIC - Silent Panic - #
- PANIC - Audible Panic - #

Burglar Alarms - 130

- 130 Burglary
- 131 Perimeter
- 132 Interior
- 133 24-Hour
- 134 Entry/Exit
- 135 Day/Night
- 136 Outdoor
- 137 Tamper
- 138 Near Alarm

- BURG - Burglary - #
- BURG - Perimeter - #
- BURG - Interior - #
- BURG - 24-Hour
- BURG - Entry/Exit - #
- BURG - Day/Night - #
- BURG - Outdoor - #
- BURG - Tamper - #
- BURG - Near Alarm - #

General Alarms - 140

- 140 General Alarm
- 141 Polling loop open

- ALARM - General Alarm - #
- ALARM - Polling Loop Open - #

EVENT	MESSAGE
142 Polling loop short	ALARM - Polling Loop Short - #
143 Expansion module failure	ALARM - Exp. Module Fail - #
144 Sensor tamper	ALARM - Sensor Tamper - #
145 Expansion module tamper	ALARM - Exp. Module Tamper - #
<u>24-Hour Non-Burglary - 150 and 160</u>	
150 24-Hour Non-Burg	ALARM - 24-Hr. Non-Burg - #
151 Gas detected	ALARM - Gas Detected - #
152 Refrigeration	ALARM - Refrigeration - #
153 Loss of heat	ALARM - Heating System - #
154 Water leakage	ALARM - Water Leakage - #
155 Foil break	ALARM - Foil Break - #
156 Day trouble	ALARM - Day Zone - #
157 Low bottled gas level	ALARM - Low Gas Level - #
158 High Temp	ALARM - High Temperature - #
159 Low Temp	ALARM - Low Temperature - #
161 Loss of air flow	ALARM - Air Flow - #
<u>Fire Supervisory - 200 and 210</u>	
200 Fire supervisory	SUPER. - Fire Supervisory - #
201 Low water pressure	SUPER. - Low Water Pressure - #
202 Low CO2	SUPER. - Low CO2
203 Gate valve sensor	SUPER. - Gate Valve - #
204 Low water level	SUPER. - Low Water Level - #
205 Pump activated	SUPER. - Pump Activation - #
206 Pump failure	SUPER. - Pump Failure - #
<u>System Troubles - 300 and 310</u>	
300 System trouble	TROUBLE - System Trouble
301 AC loss	TROUBLE - AC Power
302 Low system battery	TROUBLE - System Low Battery
303 RAM checksum bad	TROUBLE - RAM Checksum (restore not applicable)
304 ROM checksum bad	TROUBLE - ROM Checksum (restore not applicable)
305 System reset	TROUBLE - System Reset (restore not applicable)
306 Panel program changed	TROUBLE - Prog. Change (restore not applicable)
307 Self-test failure	TROUBLE - Self Test Failure
308 System shutdown	TROUBLE - System Shutdown
309 Battery test failure	TROUBLE - Battery Test Failure
310 Ground fault	TROUBLE - Ground Fault - #
311 No battery	TROUBLE - No Battery
<u>Sounder/Relay Troubles - 320</u>	
320 Sounder/Relay	TROUBLE - Sounder/Relay - #
321 Bell 1	TROUBLE - Bell/Siren #1
322 Bell 2	TROUBLE - Bell/Siren #2
323 Alarm relay	TROUBLE - Alarm Relay
324 Trouble relay	TROUBLE - Trouble Relay
325 Reversing relay	TROUBLE - Reversing Relay
326 Bell 3	TROUBLE - Bell/Siren #3
327 Bell 4	TROUBLE - Bell/Siren #4

EVENT	MESSAGE	
<u>System Peripheral Troubles - 330 and 340</u>		
330 System peripheral	TROUBLE - Sys. Peripheral - #	
331 Polling loop open	TROUBLE - Polling Loop Open	
332 Polling loop short	TROUBLE - Polling Loop Short	
333 Expansion module failure	TROUBLE - Expansion Module Failure - #	
334 Repeater Failure	TROUBLE - Repeater Failure - #	
335 Local printer paper out	TROUBLE - Printer Paper Out	
336 Local printer failure	TROUBLE - Local Printer	
<u>Communication Troubles - 350 and 360</u>		
350 Communication	TROUBLE - Communication Trouble	
351 Telco 1 fault	TROUBLE - Phone Line #1	
352 Telco 2 fault	TROUBLE - Phone Line #2	
353 Long range radio transmitter fault	TROUBLE - Radio Transmitter	
354 Fail to communicate	TROUBLE - Fail to Communicate	
355 Loss of radio supervision	TROUBLE - Radio Supervision	
356 Loss of central polling	TROUBLE - Central Radio Polling	
<u>Protection Loop Troubles - 370</u>		
370 Protection loop	TROUBLE - Protection Loop - #	
371 Protection loop open	TROUBLE - Protection Loop Open - #	
372 Protection loop short	TROUBLE - Protection Loop Short - #	
373 Fire trouble	TROUBLE - Fire Loop - #	
<u>Sensor Troubles - 380</u>		
380 Sensor trouble	TROUBLE - Sensor Trouble - #	
381 Loss of supervision - RF	TROUBLE - RF Sensor Supervision - #	
382 Loss of supervision - RPM	TROUBLE - RPM Sensor Supervision - #	
383 Sensor tamper	TROUBLE - Sensor Tamper - #	
384 RF transmitter low battery	TROUBLE - RF Sensor Batt. - #	
<u>Open/Close - 400</u>		
400 Open/Close	OPENING	CLOSING
401 Open/Close by user	OPENING - User #	CLOSING - User #
402 Group Open/Close	OPENING - Group User #	CLOSING - Group User #
403 Automatic Open/Close	OPENING - Automatic	CLOSING - Automatic
404 Late Open/Close	OPENING - Late	CLOSING - Late
405 Deferred Open/Close	Opening not used	Closing not used
406 Cancel	OPENING - Cancel	CLOSING - Cancel
407 Remote arm/disarm	OPENING - Remote	CLOSING - Remote
408 Quick arm	Opening not applicable	CLOSING - Quick Arm
409 Keyswitch Open/Close	OPENING - Keyswitch	CLOSING - Keyswitch
<u>Remote Access - 410</u>		
411 Callback request made	REMOTE - Callback Requested (restore not applicable)	
412 Success - download/access	REMOTE - Successful Access (restore not applicable)	
413 Unsuccessful access	REMOTE - Unsuccessful Access (restore not applicable)	
414 System shutdown	REMOTE - System Shutdown	
415 Dialer shutdown	REMOTE - Dialer Shutdown	
416 Success - upload/access	REMOTE - Successful Access (restore not applicable)	

EVENT	MESSAGE
<u>Access Control - 420</u>	
421 Access denied	ACCESS - Access Denied - User # (restore not used)
422 Access report by user	ACCESS - Access Granted - User # (restore not used)
 <u>System Disables - 500 and 510</u>	
 <u>Sounder/Relay Disables - 520</u>	
520 Sounder/Relay disable	DISABLE - Sounder/Relay - #
521 Bell 1 disable	DISABLE - Bell/Siren - #1
522 Bell 2 disable	DISABLE - Bell/Siren - #2
523 Alarm relay disable	DISABLE - Alarm Relay
524 Trouble relay disable	DISABLE - Trouble Relay
525 Reversing relay disable	DISABLE - Reversing Relay
526 Bell 3 disable	DISABLE - Bell/Siren - #3
527 Bell 4 disable	DISABLE - Bell/Siren - #4
 <u>System Peripheral Disables - 530 and 540</u>	
 <u>Communication Disables - 550 and 560</u>	
551 Dialer disabled	DISABLE - Dialer Disable
552 Radio transmitter disabled	DISABLE - Radio Disable
 <u>Bypasses - 570</u>	
570 Zone bypass	BYPASS - Zone Bypass - #
571 Fire bypass	BYPASS - Fire Bypass - #
572 24-Hour zone bypass	BYPASS - 24-Hour Bypass - #
573 Burglar bypass	BYPASS - Burg. Bypass - #
574 Group bypass	BYPASS - Group Bypass - #
 <u>Test Misc. - 600</u>	
601 Manual trigger test	TEST - Manually Triggered (restore not applicable)
602 Periodic test report	TEST - Periodic (restore not applicable)
603 Periodic RF transmission	TEST - Periodic Radio (restore not applicable)
604 Fire test	TEST - Fire Test (restore not used)
605 Status report to follow	STATUS - Status Follows (restore not applicable)
606 Listen-in to follow	LISTEN - Listen-in Active (restore not applicable)
607 Walk test mode	TEST - Walk Test Mode
608 System abnormal test	TEST - System Abnormal Test

Appendix H: Canadian Application

H.1 ANN-LED Annunciator Installation for Canadian Applications

- The FACP is supplied with a Dress Panel and one ANN-LED annunciator.
- When installing and programming the FACP, the Canadian Option must be set to **ON** prior to any other panel programming (refer to “Canadian Option” on page 104 of the Programming Section of this manual).
- The optional, local ANN-LED annunciators must be adjacent and close-nipped to the FACP with the wiring in metal conduit.
- When using additional ANN-LED annunciators on the primary ANN-BUS circuit, a ground wire must be daisy-chained between circuit board mounting screws on each annunciator and then connected from the last annunciator board to the Earth Ground stud in the FACP backbox. This applies only to the *primary* ANN-BUS circuit.
- If remote indicators are desired, they must be connected to the secondary ANN-BUS circuit. This requires the use of the ANN-SEC option card.
- The installer must write in the *Date of Final Assembly* on the Master Marking and Warranty Label located on the FACP backbox door.
- To comply with CAN/ULC-S559-04, the 4XTMF option must be utilized along with the configuration shown in Figure H.3.

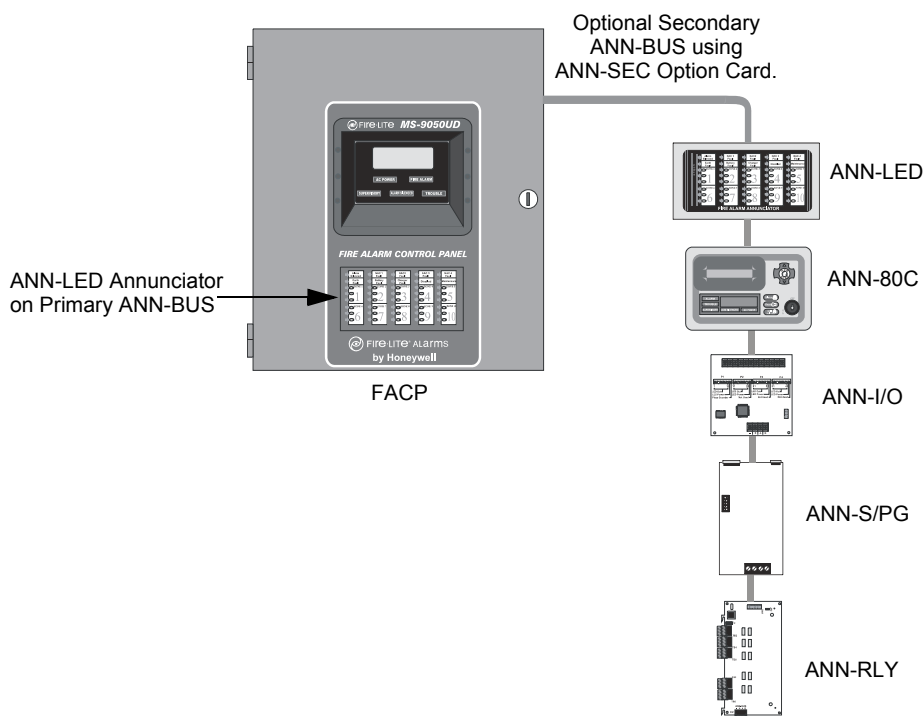

Figure H.1 FACP Minimum Configuration - Single ANN-LED Annunciator

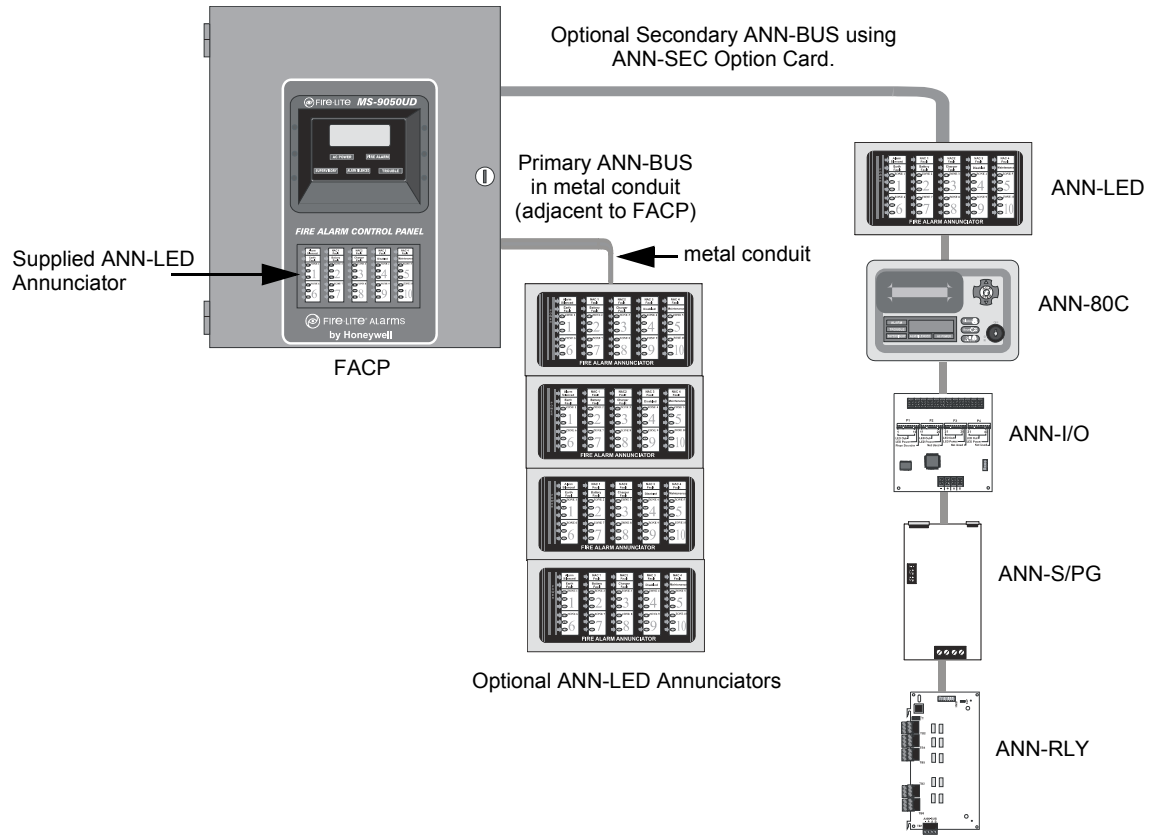

Figure H.2 FACP Maximum Configuration - Five ANN-LED Annunciators

ms_9050UDtoann_led4.wmf

Notes:

1. The CRF-300 and the MMF-300 must be mapped to the same zone which is programmed for supervisory operation.
2. No other device can be mapped to that supervisory zone.
3. Wire gauge must be 18AWG minimum.

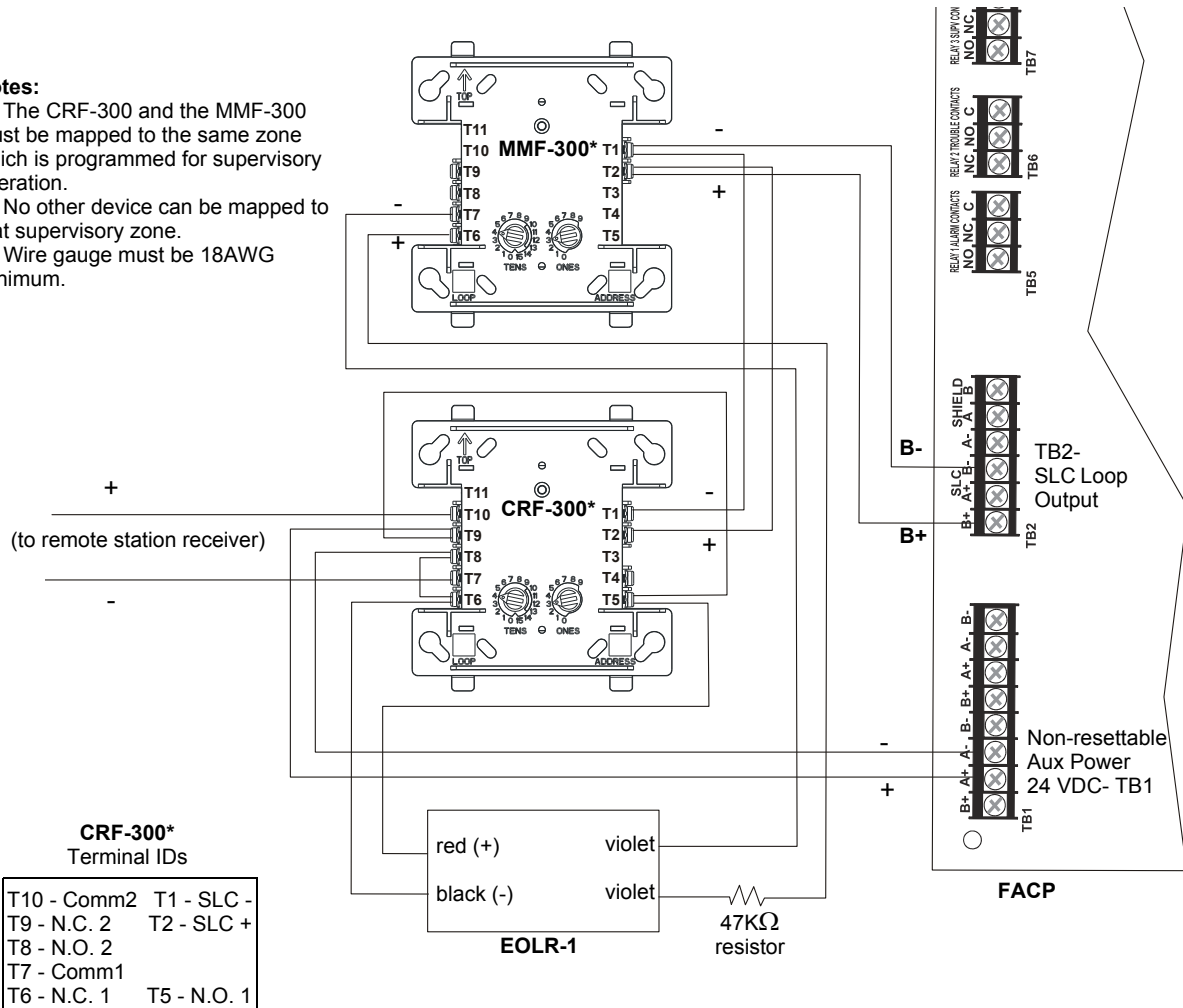

Figure H.3 Alternate Transmission for Supervisory Signals

H.2 AC Power Connections for Canadian Applications

For Canadian applications, an AC terminal block is supplied standard with the MS-9050UDC. The AC terminal block is factory installed on the bottom left of the circuit board chassis.



CAUTION: RISK OF ELECTRICAL SHOCK
 TURN OFF ALL POWER (AC & DC) BEFORE MAKING ANY CONNECTIONS.

Refer to the following illustrations for location and wiring information.

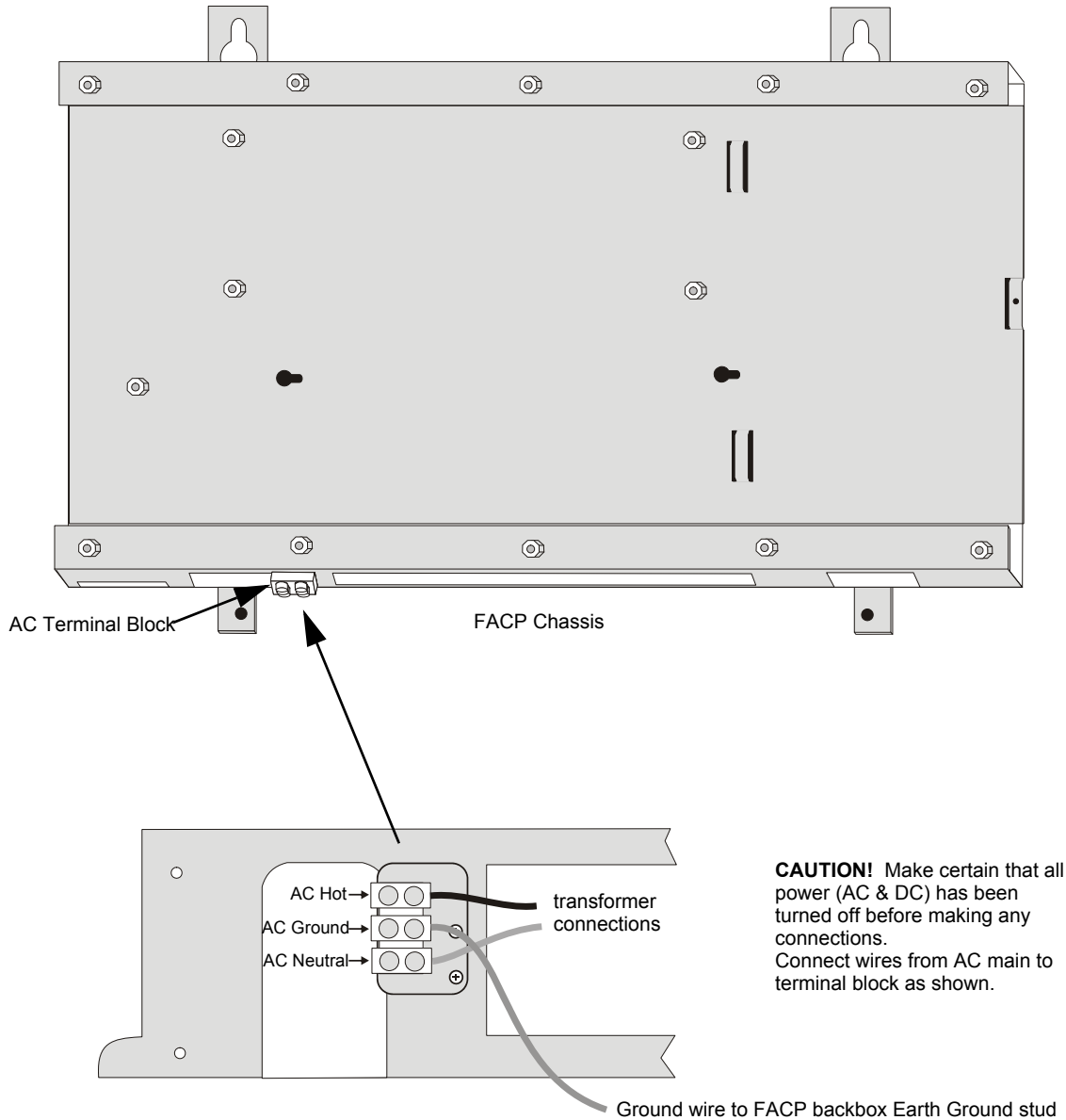

9050udchassis_acterm.wmf

9050udacterm.wmf

Figure H.4 AC Terminal Block Connections

Notes

Index

Numerics

- 24 Hour Test Time **126**
- 300 Series addressable devices **18**
- 4XTMF **13**
- 4XTMF module **192, 193**
 - installation steps **34**
- 4XTMF module installation **33**
- 4XTMF Transmitter Module **19**

A

- AC Branch Circuit
 - calculations **180**
- AC Loss Delay **97**
- AC Power **28**
 - current **14**
 - current, maximum **28**
 - voltage **14**
 - wiring **14, 28**
- Account Code **125**
- Acknowledge/Step **16, 148**
- add Detector **58**
- add Module **68**
- addressable **12**
- addressable detectors
 - see also detectors **13**
- addressable modules **18**
 - see also modules **13**
- addressing
 - see also device addressing **90**
 - see also module or detector addressing **18**
- Ademco Contact ID format **203**
- Adjective
 - control module **82**
 - list **65**
 - monitor module **75**
 - multiple entries **67**
- Adjective/Noun **64, 66**
 - control module **81**
 - monitor module **74**
- Alarm **151**
- Alarm Silence **16, 148**
- alarm verification **13, 62, 155, 158**
- ANN-80 LCD Annunciator **40**
- ANN-80C Indicator **40**
- ANN-BUS
 - EIA-485 **15**
 - guidelines **36**
 - Power **15**
 - Secondary **15**
- ANN-I/O LED Driver Module **45**
- ANN-LED Annunciator Module **48, 49**
- ANN-RLY Relay Module **49**

- ANN-S/PG Printer Module **43**
- ANN-SEC **15**
- ANN-SEC option card **35**
- Automatic Test Operation **155**
- Autoprogramming **13, 53, 57**
- Autosilence **13, 157**
 - NAC **100**

B

- backbox **18**
 - see also cabinet **27**
- Backup Reporting **123**
- Banner **90**
 - setting **91**
- battery **18**
 - cable connection **28**
 - charger **16**
 - charger capacity **14**
 - Charging Circuit **14**
 - see also secondary power **14, 28**
- battery box **20**
- battery charger **20**
 - external **20**
- BB-26
 - see also battery box **20**
- BB-55F
 - see also battery box **20**

C

- cabinet
 - dimensions **26, 27**
- cabinet mounting **24**
- Calculate System Current Draw **181**
- Calculating the Battery Size **183**
- call limit **52, 123**
- Canadian Applications **22**
- Canadian Option **90, 104**
- Central Station **122, 179**
 - account code **125**
 - communications **172**
 - phone number **126**
 - Phone Numbers **124**
 - report style **135**
- CHG-120F
 - see also battery charger **20**
- CHG-75
 - see also battery charger **20**
- Clasic Loop Interface Protocol **90**
- Class A **30**
- Class B **30**
- Clock Format **94**
- Coded Operation **156**

- Coding
 - NAC **101**
- coding
 - two stage operation **101**
- communications format **127, 128**
- Control Buttons **148**
- control module **18**
 - description display **84**
 - display **78**
 - edit **78**
 - enable/disable **79**
 - noun **83**
 - noun/adjective **81, 82**
 - silenceable **80**
 - type **79**
 - type codes **80**
- Correlations **184**
- current
 - AC Power **28**
 - availability **15**
- Current Draw Calculations **182**
- D**
- DACT
 - enable **120**
 - onboard **120**
- data
 - see also detector data and sensitivity **155**
- Data Entry
 - via computer keyboard **52**
 - via keypad **52**
- data values
 - see also detector data and sensitivity **13**
- Date setting **93**
- Daylight Savings Time **94**
- Default Programming **189**
- Delete Detector **59**
- Delete Module **69**
- Description
 - control module **84**
 - detector label **67**
 - monitor module **77**
- Detector
 - add **58**
 - adding description **64**
 - delete **59**
 - edit **59**
 - enable/disable **61**
 - screen display **60**
 - type **62**
 - verification **62**
- detector data **155, 169**
 - acceptable range **169**
 - printout **168**
- Detector Programming **58**
- Device Accessories **18**
 - device addressing **90**
 - dialer runaway **52, 123**
- Digital Communicator **21**
- dimensions
 - cabinet **26**
- DIRTY1 **169**
- DIRTY2 **169**
- Disable **86**
- Disable Point
 - Maintenance Level **140**
- Downloading **178, 179**
- dress panel **18, 19**
- drift compensation **13, 169**
 - definition **169**
- Drill **16, 148**
- E**
- edit
 - control module **78**
 - detector **59**
 - detector screens **60**
 - module, monitor **69**
- EIA **14**
- EIA-232
 - see also Printer/PC interface **13**
- Enable **85**
- Enable/Disable
 - control module **79**
 - detector **61**
 - module, monitor **71**
- End-of-Line Resistor Assembly **18**
- Enter key **55**
- EOL-C(R/W) Mounting Plate **19**
- Erase History **106**
- Error Checking **179**
- event code classification **204**
- event codes **128**
- exiting
 - programming **53, 54**
 - Read Status **53, 54**
- F**
- FACP
 - see also Fire Alarm Control Panel **12**
- Features **12**
- Fire Alarm Control Panel
 - see also FACP **12**
- Format Selection Address **173**
- Form-C relay **17, 29**
- G**
- general alarm zone **74**
 - see also zone Z00 **64**
- guidelines **36**

H

Hazard Condition **153**
 History **105**
 erase **106**
 Maintenance Level **141**
 view events **105**
 History file **13**
 HVAC Control **201**
 HVAC OVERRIDE **202**
 HVAC RESTART **201**
 HVAC SHUTDN **201**

I

Indicators **15**
 Installation **24**
 intelligent **12**
 Internet Protocol Communicator **20**
 Inventory **12**
 INVREP **169**
 IPDACT **20**

K

Key Panel **16**
 function keys **16**
 service/program keys **16**
 keyboard and keypad **52**

L

lamp test **16**
 LCD display **13, 15**
 LED
 AC Power **148**
 Alarm Silenced **149**
 Fire Alarm **149**
 Kiss-off **149**
 Primary Line Active **149**
 Secondary Line Active **149**
 see also Indicators **16**
 Supervisory **149**
 Trouble **149**
 Local Energy Municipal Box Service **33**
 Loop Setup **89**

M

Maintenance Alert **13, 155**
 levels **169**
 maintenance alert **169**
 Maintenance Program Level 2 **54, 139**
 Manual Dial Mode **135**
 Manual programming **53**
 Master Program Level 1 **54, 56**
 Medical Alert **154**
 Mode key **55**
 Module

add **68**
 addressing **18**
 delete **69**
 edit monitor **69**
 enable/disable **71**
 see also addressable modules **18**

Module Programming **68**

Monitor module **18**

adjective **75**
 enable/disable **71**
 noun **76**
 noun/adjective **74**
 type **72**
 type action **72**
 Type list **72**
 type selection **72**

Mounting

 cabinet **24**
 main circuit board **24**
 municipal box transmitter **33**

N

NAC **14, 16, 97, 99, 154**

 Auto Silence **100**
 coded **156**
 coding **101**
 current **14**
 End-of-Line Resistor **14**
 power **12**
 see also Notification Appliance Circuit **12, 30**
 silence inhibit **102**
 silenceable **99**
 Style configuration **30**
 Style Y wiring diagram **30**
 synchronized **155**
 type codes **99**
 voltage, operating **14**
 wiring Style **30**

NAC enable/disable **98**

NAC options **90**

NFPA 72 Auxiliary Fire Alarm System **191, 192**

NFPA 72 Central Station Service (Protected Premises Unit) or Remote Station Service **191**

NFPA 72 Proprietary Fire Alarm System **191**

NFPA 72 Proprietary Protective Signaling Systems **194**

NFPA 72 Remote Station Protective Signaling System **192**

NFPA Battery Requirements **183**

NFPA Standard **191**

nonpower-limited

 relay connections **29**

nonsilenceable

 waterflow **89, 104**

Normal **149**

normal display **53**
 Notification Appliance Circuit **14, 97**
 see also NAC **12, 30**

Noun
 list **66**
 monitor module **76**
 multiple entries **67**

O

Off-line Programming **53**
 Operating Instructions **148**

Operation
 alarm **151**
 disable/enable **155**
 hazard condition **153**
 medical alert **154**
 NAC **154**
 normal **149**
 process monitor **153**
 programmed zone **154**
 supervisory **152**
 trouble **150**
 waterflow **155**
 Option Modules **19, 33, 108**
 Options **12**
 Output Circuits **16**

P

PAS **63, 86, 156**
 see also Positive Alarm Sequence **13, 63**
 PAS BYPASS **157**
 PAS timer **95**
 Password **13, 54**
 change **136**
 Maintenance Level 2 **55, 139**
 Master Level 1 **55**
 PC interface **13**
 Phone Number **126**
 Piezo
 see also sounder **16**
 Point Program **57**
 Positive Alarm Sequence **63, 156**
 see also PAS **13**
 power
 NAC **12**
 power supply calculations **180**
 Power-up
 first time **54**
 Pre-signal **13, 63, 86**
 function **156**
 selection **73**
 Pre-signal Delay timer **96**
 Pre-signal timer **95**
 Primary Phone **121**
 primary power
 see also AC Power **28**

PRN-6F **44**
 Process Monitor **153**
 PROCMON AR **104**
 Program
 check **138**
 check correlations **138**
 clear **137**
 Program Check
 Maintenance Level **142**
 program keys
 see also Key Panel **16**
 Programming **52, 53**
 autoprogramming **53**
 exiting **53**
 factory default **189**
 Level 1 **54**
 Level 2 **54**
 manual **53**
 Master Level 1 **56**
 modules **68**
 off-line computer **53**
 via computer keyboard **52**
 via panel keypad **52**
 Programming Levels **54**
 Programming Screens **54**
 Programming Sheet **186, 187**
 Programming Utility
 see also PK-CD **20**
 Proprietary Yes
 see also Remote Upload **178**
 PS-Tools **20**

R

Read Status **53, 159**
 annunciators **167**
 exiting **53**
 history **165**
 NAC **164**
 power **162**
 Print **168**
 program check **165**
 relay **164**
 system point **160**
 Time-Date **170**
 timers **163**
 trouble reminder **163**
 zones **162**
 Real-Time Clock **155**
 Recall/Increment Function **67, 77, 84**
 Receivers **176**
 Relay **14, 17, 29, 103**
 connections **29**
 contact rating **14, 17, 29**
 fixed **29**
 Form-C **14, 103**
 programmable **12, 17, 29**

- programming **103**
- selections **103**
- trouble **12, 17, 29**
- Relay options **90**
- Remote Download **177**
- Remote Station Service **33**
- remote switch functions **13**
- REN
 - see also Ringer Equivalence Number **21**
- Report Style **135**
- Reporting Enable **122**
- Reset **16, 148**
- Ring Count **122**
- Ringer Equivalence Number **21**
- ROME Series **50**
- rules for ANN-BUS wiring **36**

S

- secondary ANN-BUS **15, 35**
- Secondary Phone **121**
- Secondary Power Requirements **183**
- Secret Code **179**
- Security Features **179**
- sensitivity **155, 169**
 - see also smoke detector sensitivity **155**
- Signal rate **13**
- Signaling Line Circuit
 - see also SLC **14**
- Silence Inhibit **13, 102, 157**
- Silenceable
 - control module **80**
 - NAC **99**
 - waterflow **104**
- Silenceable Alarm Relay **104**
- silenceable circuits
 - synchronized signals **99**
- Silenceable waterflow **89**
- SLC **13, 16**
 - current **14**
 - reference manual **14**
 - resistance **14**
 - see also Signaling Line Circuit **12, 14**
 - Style **16**
 - voltage **14**
 - wiring length **14**
- SLC Loop Protocol **90**
- SLC Style **89**
- smoke detector
 - chamber reading **169**
 - data **155, 169**
 - sensitivity **13, 155**
- Software Zones **12, 184**
- sounder **16**
- Specifications **14**
- strobe synchronization **13**
- Style **12**

- Style Y **30**
 - NC configuration **30**
- Style Z **30**
 - NAC configuration **30**
- subscreen **54**
- Supervisory **152**
- SUPERVISORY AR **104**
- supervisory relay
 - configuring for Transmitter Module **35**
- sync
 - programming **98**
 - see also synchronization **102**
- synchronization **155, 164**
 - by manufacturer **102**
 - programming **102**
 - see also strobe synchronization **13**
- synchronized **155**
- synchronized signals **155**
 - and silenceable circuits **99**
- System
 - Maintenance Level **144**
- System Point **160**
- System Setup **90**

T

- Telephone Circuitry **21**
- Telephone Company
 - Rights and Warnings **22**
- telephone line **31**
- Terminal **122**
- Test Time Interval **125, 126**
- Time and Date
 - Maintenance Level **144**
- Time setting **93**
- Time-Date setting **90, 93**
- Time-out **179**
- Timers **90**
- Total Comm Fault **130, 132, 134**
- Transmittal Priorities **175**
- Transmitter Module **33**
 - coil resistance **33**
 - current **33**
 - see also 4XTMF **19**
 - supervisory relay config. **35**
 - voltage **33**
- Trouble **150**
 - trouble call limit **52**
 - trouble display **150**
 - trouble relay **12**
 - Trouble Reminder **90, 157, 163**
 - Trouble Resound **90, 157**
 - trouble responses **150**
- Two Stage **86**
- two stage operation **101**
- Type
 - control module **79**

- detector **62**
- monitor module **72**
- NAC **99**
- type code
 - control module **80**
 - supervision **155**
 - verification **13**

U

- UL power-limited wiring requirements **31**
 - see also power-limited and nonpower-limited **29**
- Upload/Download **177**

V

- Verification
 - detector **62**
- Verify Loops **105**
- View Events **105**
- voltage
 - measurements **163**
 - ranges **163**

W

- Walktest **13, 63, 80, 106**
 - audible **106**
 - Maintenance Level **143**
 - operation **158**
 - selection **73**
 - silent **106**
- waterflow
 - nonsilenceable **89, 104**
 - silenceable **89, 104**
- Waterflow Delay timer **95, 96**
- Waterflow Retard Timer **158**
- Waterflow Silenceable **90**
- Wire Requirements **199**
- wiring
 - AC Power **28**
- wiring Style **12**

Z

- Z00 **64, 74**
- Z17
 - PAS zone **63**
- Z18 **64**
- Zone 17 **86**
- Zone 18 **86**
- Zone Assignment **64, 73, 102**
 - control module **81**
- Zone Setup **85**
 - Maintenance Level **145**
- zone type **88**
 - list **88**

- Zone Z17 **63**
- Zone Z18
 - pre-signal zone **64**
- Zones **162, 184**
 - see also software zones **12**
- Zones Disabled **87**
- Zones Enabled **87**
- Zones Installed **87**
- zones per device **64**

Manufacturer Warranties and Limitation of Liability

Manufacturer Warranties. Subject to the limitations set forth herein, Manufacturer warrants that the Products manufactured by it in its Northford, Connecticut facility and sold by it to its authorized Distributors shall be free, under normal use and service, from defects in material and workmanship for a period of thirty six months (36) months from the date of manufacture (effective Jan. 1, 2009). The Products manufactured and sold by Manufacturer are date stamped at the time of production. Manufacturer does not warrant Products that are not manufactured by it in its Northford, Connecticut facility but assigns to its Distributor, to the extent possible, any warranty offered by the manufacturer of such product. This warranty shall be void if a Product is altered, serviced or repaired by anyone other than Manufacturer or its authorized Distributors. This warranty shall also be void if there is a failure to maintain the Products and the systems in which they operate in proper working conditions.

MANUFACTURER MAKES NO FURTHER WARRANTIES, AND DISCLAIMS ANY AND ALL OTHER WARRANTIES, EITHER EXPRESSED OR IMPLIED, WITH RESPECT TO THE PRODUCTS, TRADEMARKS, PROGRAMS AND SERVICES RENDERED BY MANUFACTURER INCLUDING WITHOUT LIMITATION, INFRINGEMENT, TITLE, MERCHANTABILITY, OR FITNESS FOR ANY PARTICULAR PURPOSE. MANUFACTURER SHALL NOT BE LIABLE FOR ANY PERSONAL INJURY OR DEATH WHICH MAY ARISE IN THE COURSE OF, OR AS A RESULT OF, PERSONAL, COMMERCIAL OR INDUSTRIAL USES OF ITS PRODUCTS.

This document constitutes the only warranty made by Manufacturer with respect to its products and replaces all previous warranties and is the only warranty made by Manufacturer. No increase or alteration, written or verbal, of the obligation of this warranty is authorized. Manufacturer does not represent that its products will prevent any loss by fire or otherwise.

Warranty Claims. Manufacturer shall replace or repair, at Manufacturer's discretion, each part returned by its authorized Distributor and acknowledged by Manufacturer to be defective, provided that such part shall have been returned to Manufacturer with all charges prepaid and the authorized Distributor has completed Manufacturer's Return Material Authorization form. The replacement part shall come from Manufacturer's stock and may be new or refurbished. THE FOREGOING IS DISTRIBUTOR'S SOLE AND EXCLUSIVE REMEDY IN THE EVENT OF A WARRANTY CLAIM.

Warn-HL-08-2009.fm



World Headquarters
1 Firelite Place
Northford, CT 06472-1653 USA
203-484-7161
fax 203-484-7118

www.firelite.com

ISO 9001
CERTIFIED
ENGINEERING & MANUFACTURING
QUALITY SYSTEMS