



INSTALLATION MANUAL and USER'S GUIDE

System Model EWP-202C

Patent No.: U.S. 6,255,946 B1

The "E² - D²" is a Sophisticated High Quality 2-Channel Wireless Annunciator System with Entry & Exit Chime and Dual Counter.

1.0 DESCRIPTION

The E² - D² annunciator system is designed with superior dual counter active-infrared technology. The invisible dual infrared beam triggers a pleasant chime sound and registers a count on the digital counter when the infrared beam is interrupted. The transmitting signal differentiates among Entries and Exits making it an efficient device. The system counts the number of people that enter the facility and sounds a pleasant "ding dong" chime upon entering and a single "ding" sound upon exiting. Each event is counted, recorded and registered by the built-in digital counter and can be viewed and compared later in Entry/Exit modes. The annunciator is also equipped with an Alert Mode which sounds the built-in siren when triggered adding additional security.

2.0 FEATURES

- * 22 feet. detection range across doorway
- * Independent Entry/Exit counters
- * Wireless multifunction receiver
- * 200 ft. wireless RF transmission in open field
- * 2-Selective chime sounds per channel for distinctive Entry, Exit and Back door sounds
- * Chime volume control
- * Dual channel wireless receiver with status LED's
- * Wireless push-button included
- * Resettable 6-digit digital counter (up to 999999).
- * Power failure memory back-up
- * 16 million I.D. codes system
- * Advanced dual-infrared beam and superior wireless Technology

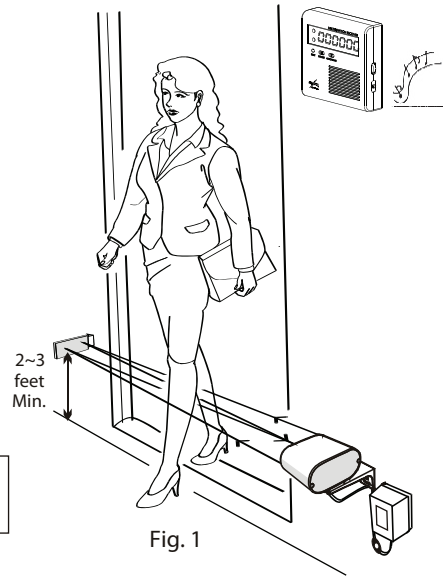

WARNING:
DO NOT INSTALL THE INFRARED SENSOR/TRANSMITTER UNDER 2 ft.

3.0 COMPLETE KIT PARTS LIST

- One (1) Wireless receiver with built-in chime and counter
- One (1) Infrared sensor/transmitter
- One (1) Wireless push-button
- One (1) Reflector
- Two (2) Power transformers (12V AC 20VA)
- One (1) 6-foot power cord
- One (1) 6-foot power cord with in-line Switch
- Mounting Brackets
- Mounting Screws and Washers

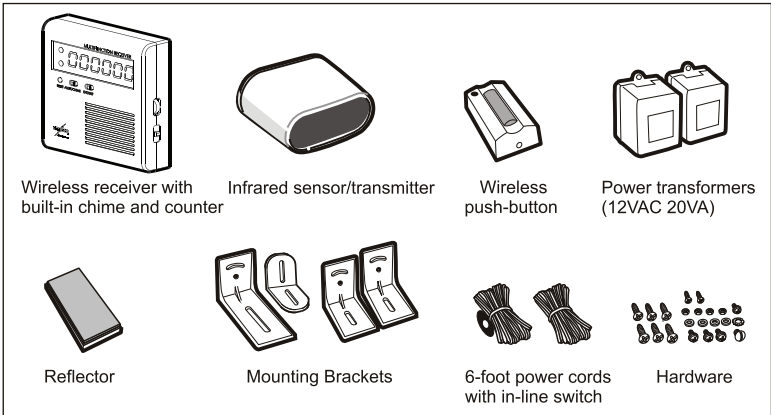

4.0 PLANNING THE INSTALLATION

It is very important that before starting the installation, you carefully read the installation instructions, and spend time planning the installation. Although installation of the system is not difficult, there are a number of steps that must be done correctly for the system to operate properly. **We suggest that the following steps be followed.**

- 1) Indoor use only
- 2) DO NOT mount the infrared sensor/transmitter facing directly into the sun light or bright lights as it may reduce the optimum operating distance.
- 3) The Wireless receiver, Infrared sensor/transmitters, wireless push button and Reflector should be mounted to a firm flat surface.
- 4) The wireless receiver should be installed at a level where it can be reached for counter reset and volume Adjustments.
- 5) The infrared sensor/transmitter, wireless receiver and wireless push button should be installed away from devices that may cause RF interference such as: electric motors, microwave ovens, refrigerators, and any other electric or electronic device that generates excessive electronic noise that may interfere with the normal operation of this device.
- 6) The infrared sensor/transmitter and reflector should be installed at a distance not to exceed the 20ft max detection range.
- 7) The wireless push button and Infrared sensor/transmitter must be mounted at a distance no greater than the maximum allowed range of 200ft in an open field between them and the wireless receiver..
- 8) The transmitting range will decrease when the following conditions exist: Steel reinforced concrete, walls with sheet-metal insulation, installing the units against a metal surface.
- 9) DO NOT install the infrared sensor/transmitter and reflector under 2-feet high.
- 10) DO NOT apply 117V AC directly, use only the transformers 12VAC 20VA provided in the kit.

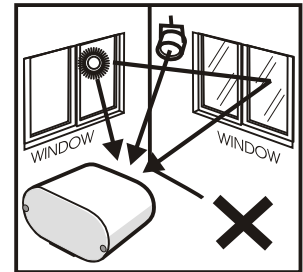
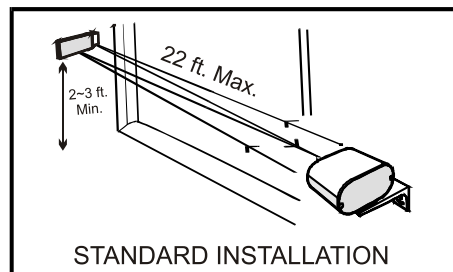
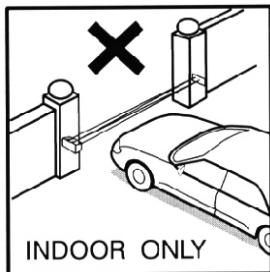

5.0 RECOMMENDED INSTALLATIONS

Dual bracket installation.

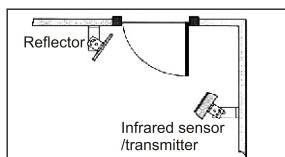

Fig. A

Direct wall mount

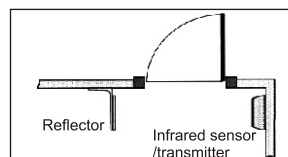

Fig. B

Single bracket installation.

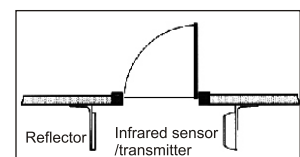

Fig. C

Installation NOT Recommended

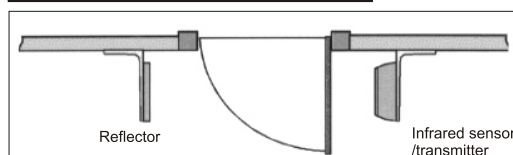

Fig. D

6.1 RECEIVER PRE-INSTALLATION TEST PROCEDURE

BEFORE INSTALLING THE WIRELESS RECEIVER IN A PERMANENT LOCATION THE FOLLOWING TEST SHOULD BE CONDUCTED.

1. Remove the screw from the bottom of the receiver and separate the front cover from the wireless receiver (refer to Fig. 7).
2. Locate the terminals labeled AC on the main board (refer to Fig. 8).
3. Using the 6-ft power cord connect the pre-stripped wires to the 12V AC 20VA transformer terminals (refer to Fig. 9). Strip the insulation on the opposite ends of the wires back approximately 1/4inch, and insert into receiver terminals labeled 12V AC input (Refer to Fig. 8).

NOTE: Prevent excess wires from lying across the floor, as you may trip over them. If necessary, use cable ties to keep the wires safely out of the way.

4. Connect the 12VAC 20VA power transformer to an AC power outlet. Make sure that the in-line switch is in the ON position, and the receiver power switch is in the ON position.
5. Turn the receiver volume control up.
6. Trigger the infrared sensor/transmitter by walking across the infrared beam. If the receiver chimes when the beam is interrupted you are within range. If NO sound is heard, you are out of range and the receiver must be installed closer to the infrared sensor/transmitter.

6.2 RECEIVER PERMANENT INSTALLATION

1. Secure the TOP mounting screw to the wall leaving some length of the screw out to hang the receiver (Refer to Fig. 10).
2. Align the receiver housing and secure the BOTTOM mounting screw firmly in place (Refer to Fig. 8).
3. Replace the receiver front cover and secure it using the screw provided (Refer to Fig. 7).

Note: Do not cut, curl or extend the antenna wire.

7.0 INSTALLING THE REFLECTOR

FOR PROPER OPERATIONS IT IS THE MOST IMPORTANT THAT YOU ALIGN THE REFLECTOR PROPERLY. THE SYSTEM WILL NOT FUNCTION OR GENERATE REPEATED CHIMES UNLESS THE REFLECTOR AND THE TRANCEIVER ARE PRECISELY ALIGNED.



THE REFLECTOR AND THE TRANCEIVER MUST PRECISELY FACE DIRECTLY TO RECEIVE BOTH OF THE REFLECTED INFRARED BEAMS.

IT IS NOT ALIGNED PROPERLY UNLESS BOTH OF THE ALIGNMENT LEDs LIGHT UP.

1. Make sure that the infrared transceiver is installed firmly facing the intended direction where the reflector is to be installed.
2. Plug in the transformer to power the unit.

THE CHIME MAY CONTINUOUSLY SOUND AFTER A WHILE DURING THE ALIGNMENT PROCEDURE UNTIL THE SYSTEM IS PROPERLY ALIGNED. HOWEVER THIS IS AN INDICATION OF MISALIGNMENT, NOT THE DEFECT.

- Assemble the bracket to the reflector with proper mounting screws provided together. **THE USE OF IMPROPER SCREWS MAY DAMAGE THE REFLECTOR.**

DO NOT SECURE THE BRACKET TO THE WALL AT THIS STAGE, WHICH MAY MAKE ALIGNMENT OF THE REFLECTOR DIFFICULT.

- Hold the reflector in front of the infrared transmitter and adjust the angle slowly **SO THAT BOTH OF THE ALIGNMENT INDICATOR LED LIGHT UP.**

If it is difficult to make both of the alignment LEDs ON then start at the closer distance and then move slowly behind to the Intended installation position maintaining the angle.

- Secure the reflector in place making sure the alignment LED's stay ON.

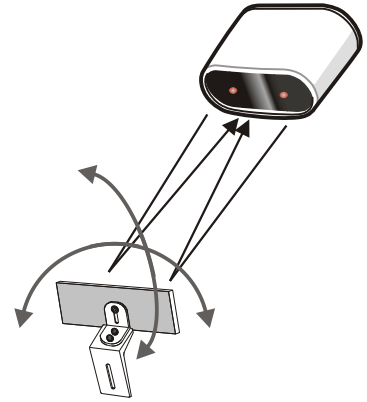

8.0 WIRELESS PUSH BUTTON INSTALLATION

- Select a suitable location for the wireless push button.
- Test the unit first to make sure you are within range of the receiver.
- Remove the screw from the bottom of the sensor/transmitter and separate the front cover (refer to Fig. 10).
- Using the 1/2 " sheet metal screws provided secure the back plate to a flat non-metal surface.
- Replace the front cover and secure it using the screw provided (refer to Fig.10).

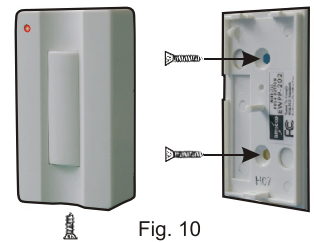

Note: The range between the wireless push button and the receiver is 200 ft. in open field. Installing the wireless push button against a metal surface will significantly reduced the range.

9.0 INFRARED SENSOR/TRANSMITTER OPERATION (EWPT-202)

AC : 12V AC input

CN1 Chime terminal output

- (-) : ground output
- (+V) : 12V DC output
- (OC) : (-) signal out when Exit
- (IC) : (-) signal out when Enter

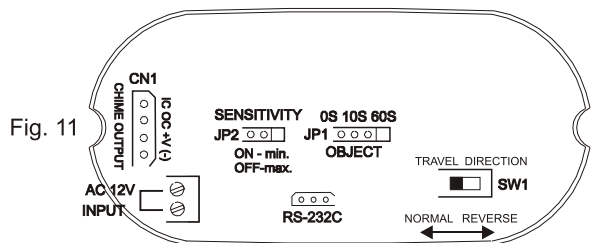

JP1: Blocked Infrared beam warning OFF 10sec. 60sec.

When the infrared beam is blocked the system will beep continuously for 10 seconds (factory setting). The system will chime continuously until the blockage is removed. Refer to above jumper for settings.

JP2: Sensitivity (Detection Range)

- JP2 OFF= 22ft. beam across doorway (factory setting).
- JP2 ON = 10ft beam across doorway

ON OFF

SW1: Travel Direction Switch

- Normal or Reverse
- Factory switch setting Normal mode

Normal Reverse

10.0 RECEIVER OPERATION (EWPR-202)

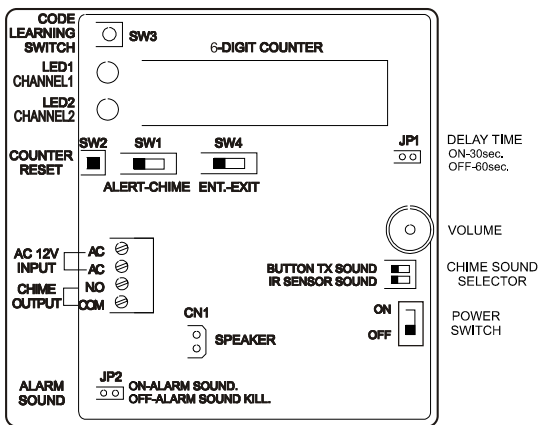

SW1 ALERT/CHIME:

" **Chime Mode** " announces arriving guests, customers, and visitors with the sound of a chime and generates a visual count every time the unit is triggered when entering or exiting.

" **Alert Mode** " alerts user of trespassers and activates the built-in siren when violated.

After setting the receiver to " Alert Mode " for the first time, the digital counter will display " AL 0 ", and the timer will allow you 30/60 seconds (selectable) to exit.

When re-entering the system must be deactivated prior to the 30/60 timer expiring or the alarm will sound.

To deactivate system slide the switch to the " CHIME " position.

ALERT MODE:

The Alert Mode is designed as a local alarm and it triggers the built-in siren for 50 seconds when the system is violated. The built-in entry and exit timer can be selected for 30 or 60 seconds.

SW2 COUNTER RESET:

Resets both Enter and Exit counters in the " CHIME MODE ".

Resets the alarm memory in the " ALERT MODE ".

SW3 CODE LEARNING SWITCH:

Adding additional sensor/transmitters

- 1) Enter the programming mode, Press and hold down the " CODE LEARNING SWITCH " for approx. 5 seconds or until you hear a single beep. The receiver memory will display the following:

The first digit is designated as channel-1 memory location and displays the number of infrared transmitter programmed on channel one.

The second digit is designated as channel-2 memory location and displays the number of wireless push-buttons programmed on channel two..

- 2) Activate the transmitter you wish to program. The display will show:
- 3) Exit the programming mode, Press and hold down the " CODE LEARNING SWITCH " for approx. 3 seconds.

Erasing all transmitter codes and reprogramming the receiver

- 1) Enter the programming mode, Press and hold down the " CODE LEARNING SWITCH " for approx. 10 seconds until the 2-channel LED's light-up and the digital display resets to the following.
- 2) Activate the transmitter you wish to program. The display will show:
- 3) Exit the programming mode, Press and hold down the " CODE LEARNING SWITCH " for approx. 3 seconds.

SW4 ENT./EXIT: Displays the " ENTRY " and " EXIT " counter readout.

JP1: ENTRY/EXIT DELAY TIMER:

Jumper ON : 30 seconds (factory setting).

Jumper OFF: 60 seconds

JP2: ALARM SOUNDER:

Jumper ON : generates a 50 seconds warble sound when alarm is triggered (factory setting).

Jumper OFF: silence the alarm warble sounder.

CHIME MODE: The Relay provides a dry contact closure for 2-seconds every time it detects an entry.
ALERT MODE: The Relay closes and stays close for the 50-seconds alarm duration unless disarmed.

CHIME SOUND SELECTOR:

Dip Switch 1 is designed to change the chime sound on the infrared sensor/transmitter only.

ON - Entry : HIGH FREQUENCY (Ding-Dong).
 Exit : HIGH FREQUENCY (Ding).

OFF - Entry : LOW FREQUENCY (Ding-Dong).
 Exit : HIGH FREQUENCY (Ding).

Dip Switch 2 is designed to change the chime sound on the wireless push-button sensor/transmitter only.

ON - Ding.
OFF - Ding-Dong.

CHANNEL1: LED comes ON when receiving a signal from infrared sensor/transmitter.

CHANNEL2: LED comes ON when receiving a signal from push-button sensor/transmitter.

TERMINAL BLOCK:

AC: 12V AC input

AC: 12V AC input

BUILT-IN RELAY

N.O. : Normally Open relay terminal.

COM: Common relay terminal.

10.1 FRONT PANEL CONTROLS

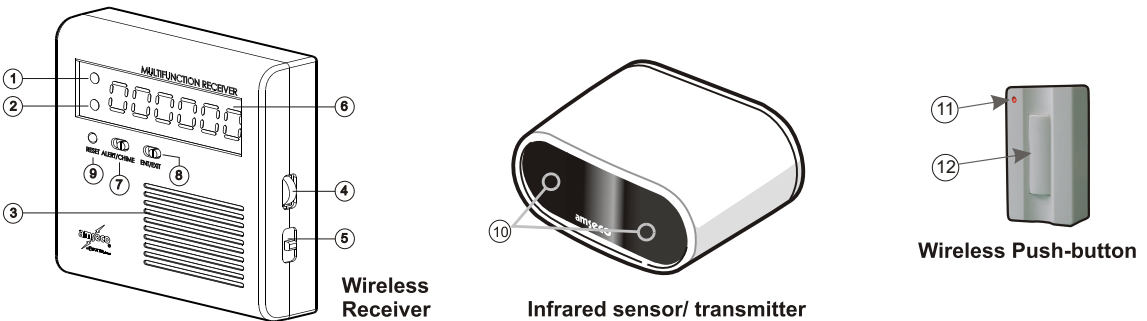

1. CHANNEL-1: Visual indicator (red LED) lights-up when the infrared sensor/transmitter is triggered.
2. CHANNEL-2: Visual indicator (red LED) lights-up when the wireless push button is activated.
3. BUILT-IN SPEAKER: Provides sound output, so you can hear the chime wherever is mounted.
4. VOLUME CONTROL: Adjusts the sound level output.
5. POWER SWITCH ON/OFF: Slide power switch up to turn receiver ON.
Slide power switch down to turn receiver OFF.
6. DIGITAL COUNTER: Displays the 6-digit easy viewing counter or alarm memory.
7. ALERT/CHIME: " Alert mode " use as a local warning device.
" Chime mode " use for annunciation of customers, guest and visitors.
8. ENTRY/EXIT: Displays the " ENTRY " counter only.
Displays the " EXIT " counter only.
9. RESET BUTTON: " Chime mode " Resets both ENTRY and EXIT counters to zero.
" Alert mode " Resets the alarm memory only.

INFRARED SENSOR/TRANSMITTER (EWPT-202)

10. ALIGNMENT LED's: 2-LED's provided for easier set-up.

WIRELESS PUSH-BUTTON (EWPP-202)

11. STATUS LED: Lights-up when transmitting.

12. BUTTON: Transmits (RF) signal when pressed.

11.0 WIRING OPTIONAL CM-4 CHIME

Infrared Sensor/Transmitter (EWPT-202)

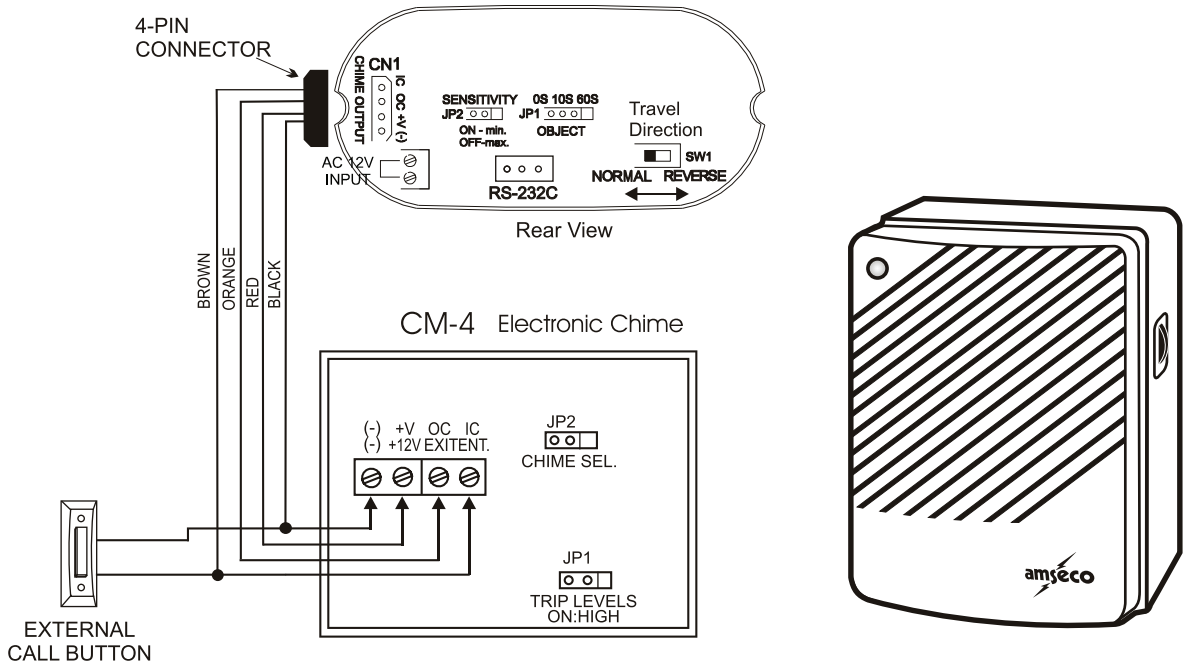

Refer to CM-4 Installation Instructions

12.0 TROUBLESHOOTING

Problem	Probable Cause	Solution
The chime does not sound when the infrared beam is interrupted.	1. The power may be off. 2. The sensor/transmitter may be out of range.	Turn the receiver power switch ON. Turn the volume control up. Install the receiver closer to the sensor/transmitter.
The chime sounds continuously	1. The infrared beam is blocked. 2. Alignment may be off.	Clear the infrared beam pathway. Refer to owners manual alignment procedure
The chime dings once when entered and twice when exit.	1. The travel direction switch is in the wrong position.	Refer to infrared sensor/transmitter installation instructions.
Counter displays the wrong characters	1. Receiver may be locked.	Turn the power switch OFF then back ON.

13.0 SPECIFICATIONS :

Part No/Model	EWPT-202	EWPP-202	EWPR-202
Description	Infrared Sensor / Transmitter	Wireless Push-button	Wireless Receiver
Detection method	Active Infrared	-	RF
Detection Range	10ft. JP2=ON	-	-
	22ft. JP2=OFF(factory setting)	-	-
Max. Transmission Range	200ft. Open field	200ft. Open field	-
Power Source	12V AC/20VA	12V DC battery included	12V AC/20VA
Power Consumption: Standby	500mA. (AC)	-	180mA. (AC)
	: In alarm	1Amp. (AC)	500mA. (AC)
Volume Control	-	-	0 ~ 85dB.
Chime Sounds selectable	-	Dip Switch : 2	Dip Switch : 1
Response Time	4m Sec.	-	-
Light Source	Infrared pulse beam 950nm	-	-
Wireless frequency	315MHz	315MHz	315MHz
Chime terminal output(-)	Ground	-	-
Chime terminal output(+V)	12V DC 1A output	-	-
Chime terminal output(OC)	Exit output(-) TR output 1A	-	-
Chime terminal output(IC)	Entry output(-) TR output 1A	-	-
Terminal 1	12V AC input	-	12V AC input
Terminal 2	12V AC input	-	12V AC input
Terminal 3	-	-	Relay dry contact N.O.(2sec)
Terminal 4	-	-	Relay dry contact COM(2sec)
Entry delay timer	-	-	JP1 ON=30 sec. (factory setting) JP1 OFF=60 sec.
Exit delay timer	-	-	JP1 ON=30 sec. (factory setting) JP1 OFF=60 sec.
Alarm Sound Duration	-	-	50 sec.
Alarm Sound ON/OFF	-	-	JP2 ON=Sound (factory setting) JP2 OFF=No Sound
Sensitivity	JP2 ON=Min JP2 OFF=Max (factory setting)	-	-
Travel Direction	Sw1 Selectable Normal or Reverse (factory setting : Normal)	-	-
Installation location	Indoor	Indoor	Indoor
Blocked infrared Beam Warning	JP1 selectable : OFF / 10sec/ 60sec (factory setting : 10sec)	-	-
Counter Memory	-	-	EEPROM
Security Codes Available	-	-	16 million
Programmable transmitter per channel	-	-	Four
Operating temperature	14°F~122°F (-10°C~50°C)	14°F~122°F (-10°C~50°C)	14°F~122°F (-10°C~50°C)
Weight	0.42 pound(190g)	1oz(28g)	0.5 pound (220g)
Dimension : (W x H x D)	3-7/32" x 2-5/16" x 4-5/16" (82 x 59 x 100mm)	1-7/32" x 11/16" x 2-3/16" (31 x 17 x 56mm)	1-5/16" x 4-11/16" x 4-11/16" (29 x 120 x 120mm)
Total Weight(w/box)	4.1 pound(1.85kg)	Carton Dimension	12-3/8" x 4-1/8" x 10-7/16" (315 x 105 x 265mm)

This device complies with part 15 of the FCC rules.

2010.08.23