

DS939 Ceiling Mount PIR Intrusion Detector

1.0 Specifications

- **Dimensions (HxDia):** 8.9 cm x 17.8 cm (3.5 in x 7 in)
- **Coverage:** 360° by 21 m (70 ft) diameter coverage when mounted on 3.7 to 7.6 m (12 to 25 ft) high ceilings. A coverage area of 12 m (40 ft) is available when mounted at 2.4 m (8 ft) and a coverage of 15 m (50 ft) is available when mounted at 3 m (10 ft). The pattern consists of 69 zones grouped into 21 barriers. Each barrier is 10.7 m (35 ft) long and 1.5 m (5 ft) wide at 10.7 m (35 ft). The barriers are divided into 3 groups of 7 barriers, each of which has a vertical adjustment for custom coverage.
- **Input Power:** 9.0 to 15.0 VDC; 12 mA standby, 39 mA in alarm with LEDs enabled. Use only a Listed Limited Power Source.
- **Standby Power:** There is no internal standby battery. 12 mAh is required for each hour of standby time needed. *For UL Listed Requirements, four hours of standby current (48 mAh) is required.* Standby power must be provided by a Listed Limited Power Source.
- **Sensitivity:** Low/High settings.
- **Alarm Relay:** Silent-operating Form "C" relay. Contacts rated 125 mA, 28 VDC, 3 watts maximum for DC resistive loads. The contacts transfer on alarm for a period of 4 seconds. Some countries require the relay to be connected to a SELV (Safety Extra-Low Voltage) circuit only. Do **not** use with capacitive or inductive loads.
- **Tamper:** Normally Closed (with cover in place) tamper switch. A wall (base) tamper is included. Contacts rated at 28 VDC, 125 mA, 3 watts maximum. Some countries require the switch to be connected to a SELV (Safety Extra-Low Voltage) circuit only. Connect tamper circuit to a 24-hour protection circuit.
- **Temperature Range:** The storage and operating range is -40° to +49°C (-40° to +120°F). *For UL Listed Requirements, the range is 0° to +49°C (+32° to +120°F).*
- **US Patent Numbers:** This detector is protected by one or more of the following: #4,764,755. Other patents pending.
- **Compliance:** This device complies with Part 15 of the FCC Rules and with RSS-210 of Industry and Science Canada. Operation is subject to the following two conditions:
(1) this device may not cause harmful interference, and
(2) this device must accept any interference received, including interference that may cause undesirable operation.
Changes or modifications not expressly approved by Bosch Security Systems can void the user's authority to operate the equipment.
- **Listings:** c-UL-US
C-Tick
INCERT B-509-0015

2.0 Installation Considerations

- **Never** install the detector in an environment that causes an alarm condition. Good installations start with the LED **OFF** when there is no target motion. It should never be left to operate with the LED in a constant or intermittent alarm (red) condition.
 - Avoid installations where rotating machines (e.g. ceiling fans) are normally in operation within the coverage pattern. Point the unit away from glass exposed to the outdoors and objects that may change temperature rapidly.
- Note:** The PIR detector will react to objects rapidly changing temperature within its field-of-view.
- For optimum detection, select a location likely to intercept an intruder moving *across* the coverage pattern.

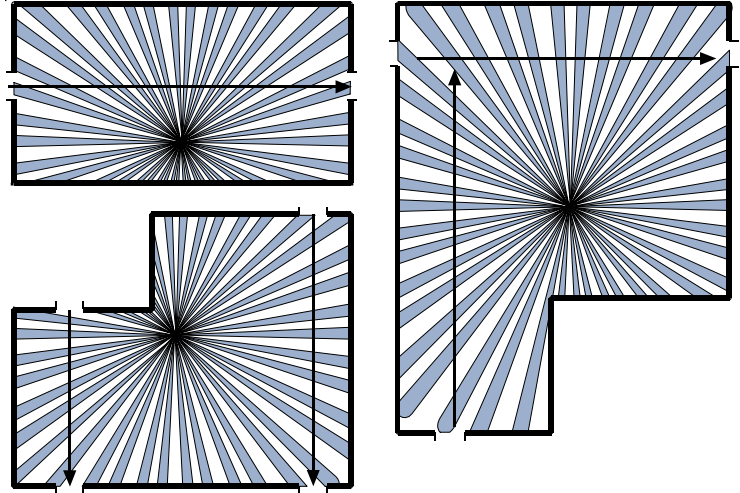

3.0 Mounting

- Recommended mounting height range is 3.7 to 7.6 m (12 to 25 ft). A coverage area of 12.2 - 21.3 m (40 to 70 ft) is available when mounted between 2.4 to 3.7 m (8 to 12 ft).
- The surface should be solid and vibration-free. (i.e. drop tiles should be secured if the area above the tiles is used as an air return for HVAC systems).
- To open the detector, locate the arrow on the cover of the detector
①. Turn a screwdriver in the recess between the cover and the base ②. One side of the cover will remain attached to the base of the detector.

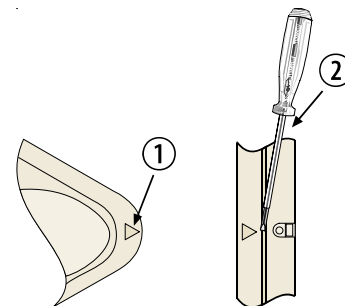

BOSCH

- If necessary, you may remove the base from the cover by pressing the two cover release tabs (3) inward while lifting the base away from the cover.

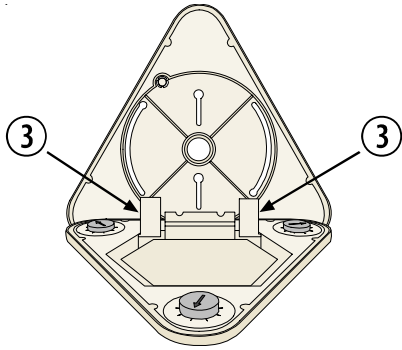

- Route wiring as necessary to the rear of the base and through the center hole.

Note: Be sure all wiring is de-energized before routing.

- Firmly mount the base. Depending on local regulations, the base may be directly surface mounted using anchors, mollies, or wing-nuts. It may also be mounted to standard 3.5 in. octagonal electrical box. The detector may also be connected directly to short lengths (short enough to avoid movement of the detector) of 1.27 cm (1/2 in) EMT.

Hint: Mounting to removable ceiling tiles is not recommended unless a sandwich is made of the base, ceiling tile, and a back plate behind the tile.

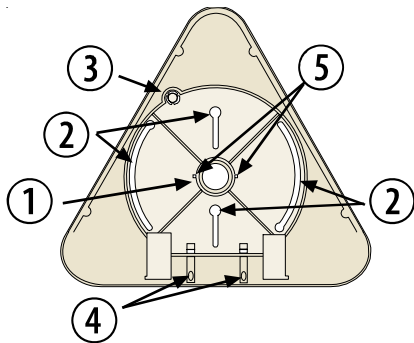

Mounting Base

- Wire entrance and/or EMT Mounting.
- Mounting holes.
- Tamper Post.
- Wire entrance for surface mounting.
- Holes for cable ties.

Note: Using the curved mounting slots (2) allows the detector to be rotated up to 60° to obtain the desired coverage.

- If ceiling tamper is desired, loosen the tamper post by cutting the 3 tabs (6) and mount the post to the ceiling using a #8 screw (7).

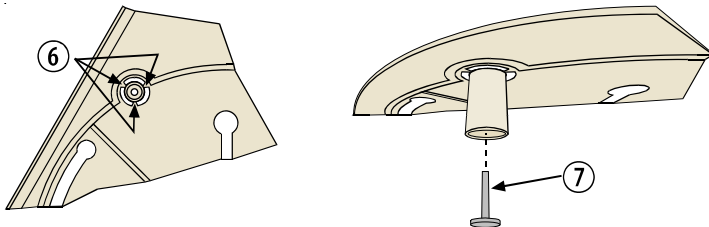

5.0 Wiring



Only apply power after all connections have been made and inspected. Do not coil excess wiring inside detector.

Note: Input power must use only a Listed Limited Power Source. Some countries require that the Alarm and Tamper Contacts be connected to a SELV (Safety Extra-Low Voltage) circuit only.

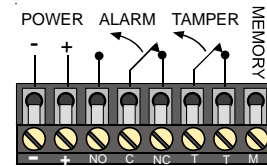

- Terminals 1 (-) & 2 (+):** Power limits are 9 to 15 VDC. Use no smaller than 0.8 mm (#22 AWG) wire pair between the unit and the power source.
- Terminals 3 (NO), 4 (C), & 5 (NC):** Alarm relay contacts rated 125 mA, 28 VDC maximum for DC resistive loads. Use terminals 4 & 5 for Normally Closed circuits. Do not use with capacitive or inductive loads.
- Terminals 6 (T) & 7 (T):** Normally Closed tamper contacts rated at 28 VDC, 125 mA.
- Terminal 8 (M):** The memory mode requires a supply voltage on Terminal 8 to be activated. See Section 8.1 for operation and wiring information.

6.0 LED Operation

The detector uses a red LED to indicate the various alarm and supervision conditions that may exist. See chart below.

LED	CAUSE
Steady red	Unit alarm
Steady green	PIR activation (walk test)
Flashing red	Warm-up period after power-up
Flashing red (4 pulse sequence)	Replace Unit

7.0 Feature Selection

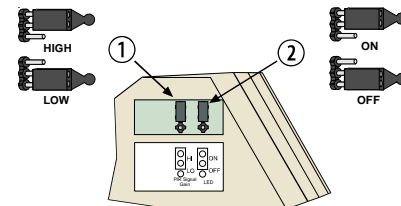

7.1 PIR Sensitivity Selection Pins (1)

For selection, place the plug across the appropriate pins. **No jumper across the "HIGH/LOW" pins puts the detector in a "High" setting.**

- Low Sensitivity (LO):** The recommended setting for most installations. This setting tolerates environment extremes. **The detector is shipped in Low Sensitivity mode.**
- High Sensitivity (HI):** Use in locations where adequate catch performance is not achieved in the Low Sensitivity mode. This setting tolerates only minor environmental changes.

Note: For UL Listed Requirements, set the PIR sensitivity to HIGH when installing the detector at heights of 3.7 m (12 ft) or higher.

7.2 LED On/Off Pins (2)

The ON position allows operation of the LED. If LED indication is not desired after setup and walk tests are completed, place in the OFF position. **No jumper across the "ON/OFF" pins disables the LED.**

- Walk test the unit from all directions to determine all the detection pattern boundaries.

Note: Wait at least 2 minutes after power up before walk testing.

8.0 Other Information

8.1 Memory, Day Mode, Night Mode and Remote Walk Test

Note: Memory, Night Mode and Remote Walk Test require a supply voltage on Terminal 8 to activate these features. This supply voltage must be between 6 and 18 VDC. You may use a switch as shown below:

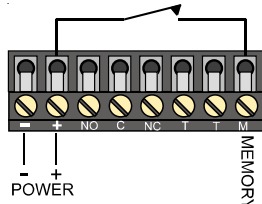

Or use an external power supply as shown below:

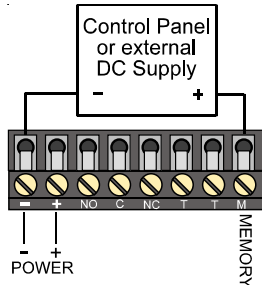

Note: Control voltage: +6 to +18 VDC = ON (Switch Closed)
0 VDC = OFF (Switch Open)

- **Day Mode:** The Day Mode disables the alarm memory and allows the LED (if activated) to operate normally.
- **Memory:** When the DS939 is in the Night Mode the memory is activated. This allows the detector to store an alarm for display at a later time.

Note: Memory mode requires that the LED jumper be in the ON position.

- **Night Mode:** The Night Mode enables the alarm memory and disables the LED operation.
- **Remote Walk Test:** This feature allows the LED operation to be remotely enabled via Terminal M for walk testing. This feature is used when the LED operation is disabled by having the LED jumper in the OFF position.

Desired Action	Control Voltage (Terminal M)	LED Jumper
Turn ON Night Mode	ON (for more than 20 sec)	ON
Turn OFF Night Mode/Display Stored Alarm	OFF (from Night Mode)	ON
To RESET Stored Alarm	ON (for more than 5 sec or enter Night Mode)	ON
Turn ON Remote Walk Test (if OFF)	ON (for more than 5 sec but less than 20 sec)	OFF
Turn OFF Remote Walk Test (if ON)	ON (for more than 1 sec but less than 20 sec)	OFF

8.2 Anti-Vandal Screw

- After the cover has been closed, the entire assembly can be secured together using the supplied anti-vandal screw ①.

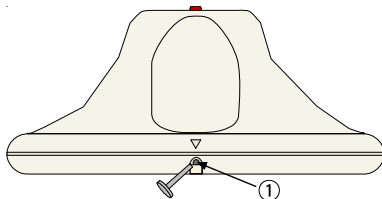

8.3 Maintenance

At least once a year, the range and coverage should be verified. To ensure continual daily operation, the end user should be instructed to walk through the far end of the coverage pattern. This ensures an alarm output prior to arming the system.

9.0 Coverage Pattern

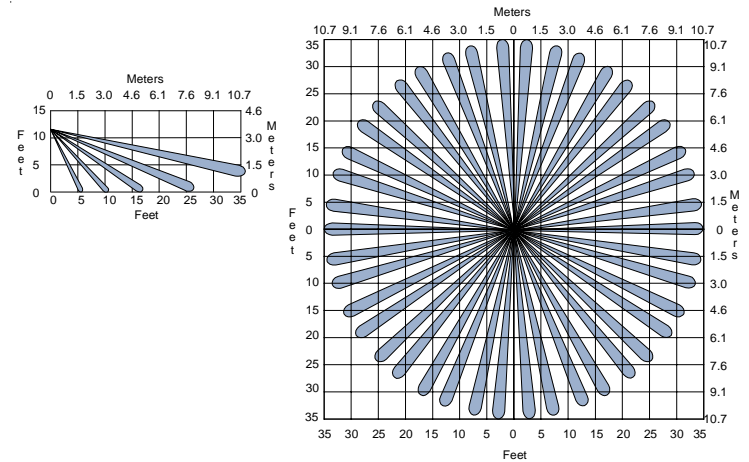

Coverage shown at 3.7 m (12 ft) mounting height.

10.0 Coverage Pattern Masking

The DS939 is provided with a set of masks to allow masking undesired areas. The masking kit contains two 120° and two 90° masks. The masks are designed to go on the **outside** of the detector. **Do not** attempt to open the detector to place the masks on the inside.

With the supplied masks, you can mask 90°, 120°, 180°, 210°, 240° or 330°. Some examples are shown below.

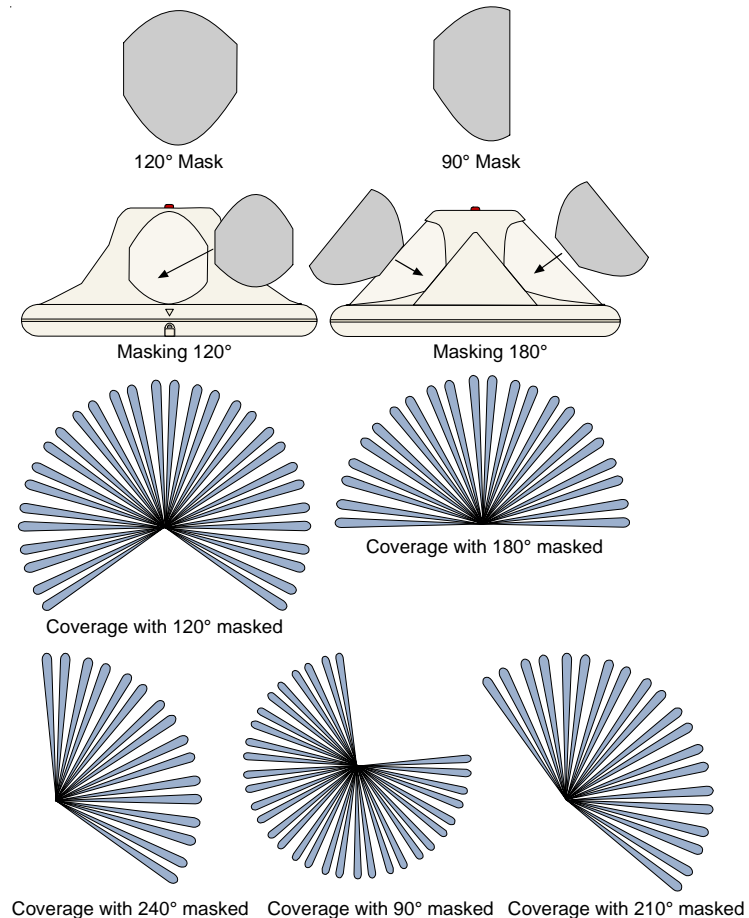

11.0 Optical Module Adjustment

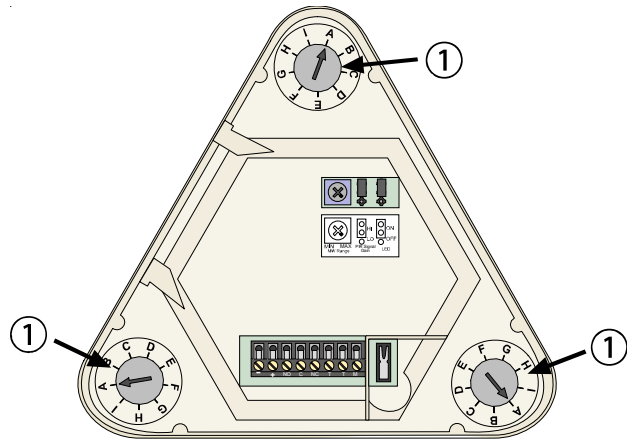
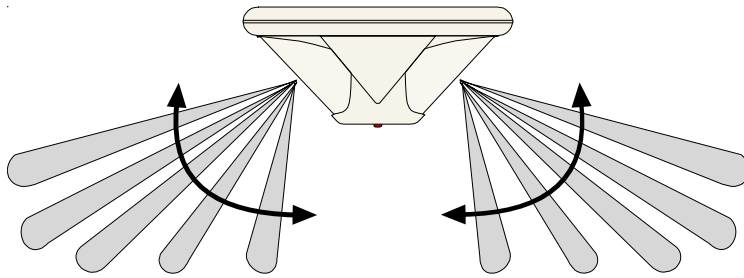

- The PIR zones of the DS939 are divided into three groups. Each of these 3 groups can be independently adjusted vertically to provide the best coverage within a room.

Only two coverage patterns are shown for clarity.

PIR vertical adjustment knobs ①

- Use the following chart to adjust the optical modules based on the mounting height of the detector. The range shown is the distance from the detector to the outside edge of the coverage pattern.

Maximum Range Meters (Feet)	Mounting Height Meters (Feet)											
	2.4 (8)	3 (10)	3.7 (12)	4.3 (14)	4.6 (15)	4.9 (16)	5.5 (18)	6.1 (20)	6.7 (22)	7.3 (24)	7.6 (25)	
3 (10)	C	A										
4.6 (15)	G	D	A	A								
6.1 (20)	I	G	D	B	A	A						
7.6 (25)		I	F	E	D	C	A	A				
9.1 (30)			H	F	E	E	C	B	A			
10.7 (35)			I	G	G	F	E	C	B	A	A	

- In installations where a targeted coverage is required for part of the area, the optical modules must be adjusted for the correct coverage. In the example below, the detector is mounted 3.7 m (12 ft) above the floor. The distance to one wall is 6.1 m (20 ft) and 10.7 m (35 ft) to the opposite wall. Using the chart above, the optical module for the 6.1 m (20 ft) range was set to "D" and the optical module for the 10.7 m (35 ft) was set to "I".

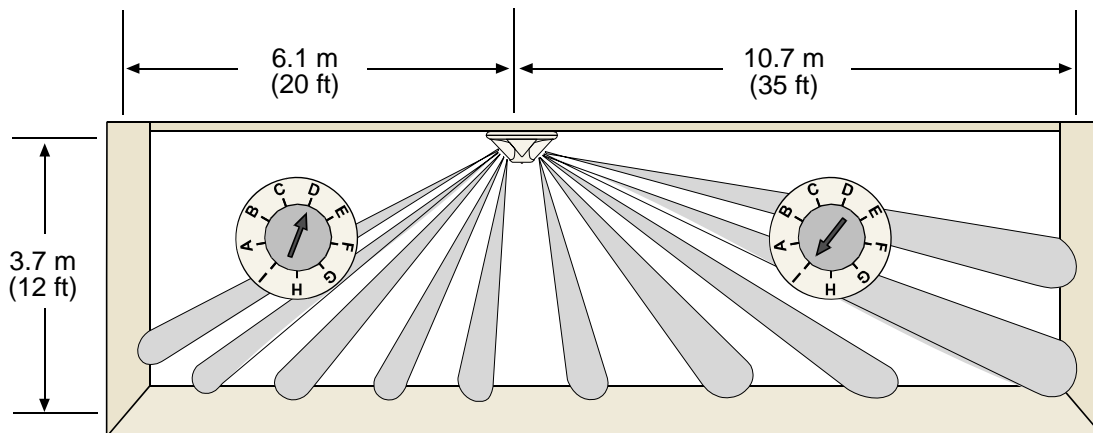

Only two coverage patterns are shown for clarity.

12.0 Remote Walk Test

1. Ensure that the LED jumper is ON. Refer to *Section 7.2* on page 2.
2. Wait at least 2 min after power-up before starting the Remote Walk Test. The red LED flashes until the detector stabilizes.
3. Watch the LED as you walk toward the edge of the detector's coverage pattern. The LED lights when you reach the outside edge of the coverage pattern. The red LED indicates an alarm.
4. Repeat *Step 3* from different directions until you have adequately verified the coverage pattern.

Note: If you cannot obtain the required coverage by performing *Steps 1-3* above, set the PIR sensitivity to HIGH to obtain maximum range. Refer to *Section 7.1* on page 2. Adjust the optical module accordingly, as described in *Section 11.0* on page 4. Repeat *Steps 2-4* to ensure proper coverage.

