



CX-ED2071/ED2079

'UNIVERSAL' LOW PROFILE GRADE 2 ELECTRIC STRIKES



CX-ED2079 AND STAINLESS STEEL FACEPLATES

FEATURES

- CENTERLINE LATCH ENTRY, FOR CYLINDRICAL LOCKSETS
- 1/2" - 5/8" (13MM - 16MM) LATCH PROJECTION
- FIELD SELECTABLE FAIL SAFE/FAIL SECURE OPERATION
- HORIZONTAL ADJUSTABILITY OF STRIKE BODY
- LOW PROFILE STRIKE BODY
- CX-ED2079: 12/24V STRIKE C/W 3 STAINLESS STEEL FACEPLATES ANSI SQUARE, HOLLOW METAL DOOR AND WOOD DOOR
- CX-ED2079-1: 12/24V STRIKE C/W 1 STAINLESS STEEL FACEPLATE ANSI SQUARE
- CX-ED2079: 8V - 16V STRIKE C/W 3 STAINLESS STEEL FACEPLATES ANSI SQUARE, HOLLOW METAL DOOR AND WOOD DOOR
- 5 YEAR WARRANTY

DESCRIPTION

Camden CX-ED2071 low profile grade 2 ANSI electric strike for cylindrical locksets provides exceptional value, for installations that require 8 - 16V AC/DC operation. CX-ED2071 includes 3 faceplates, selectable fail safe/fail secure operation and horizontal adjustment of the strike body.

Camden CX-ED2079 low profile 'Universal' grade 2 ANSI electric strike for cylindrical locksets provides exceptional value with 3 faceplates, and selectable 12/24V AC/DC voltage, fail safe/fail secure operation and horizontal adjustment of the strike body. UL 1034 Burglary Listed.

Camden CX-ED2079-1 Low profile 'Universal' grade 2 ANSI strike for cylindrical locksets, with (1) ANSI square faceplate, provides the best strike value.

APPLICATION

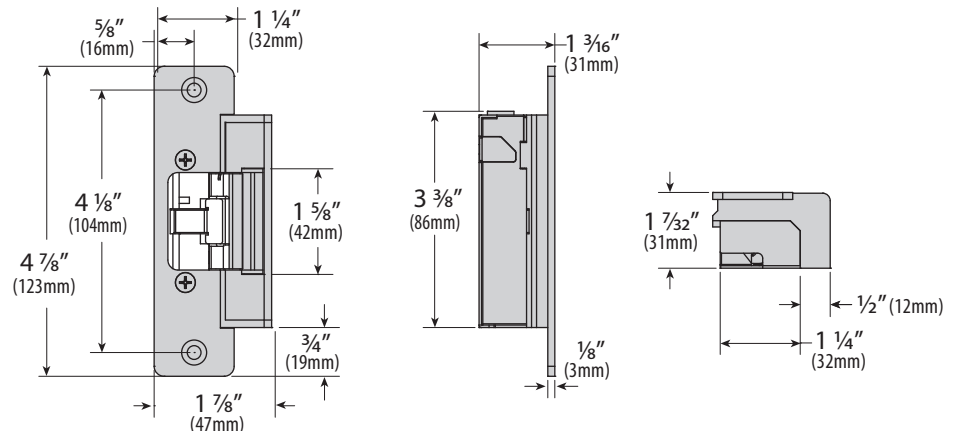

DOOR FRAME TYPES



COMPATIBLE LOCKSETS



CX-ED2071 & CX-ED2079 'UNIVERSAL' LOW PROFILE GRADE 2 ELECTRIC STRIKES

SPECIFICATIONS

VOLTAGE:	CX-ED2071: 8 - 16V, AC/DC, CX-ED2079: 12/24V, AC/DC
CURRENT DRAW:	CX-ED2071: 305MA@8VDC, 625MA@16VDC, 190MA@8VAC, 460MA@16VAC CX-ED2079: 300MA @12VDC, 150MA@24VDC
STATIC STRENGTH:	1,000 LBS.
DYNAMIC STRENGTH:	50 FT. LBS.
ENDURANCE:	CX-ED2071 & CX-ED2079: 700,000 CYCLES CX-ED2079: 250,000 CYCLES (UL VERIFIED)
MODE:	SELECTABLE FAIL SAFE FAIL SECURE
OPERATION:	AC - BUZZ DC - SILENT
DUTY:	CX-ED2071: INTERMITTENT, CX-ED2079: CONTINUOUS
MOUNTING:	NON-HANDED
DIMENSIONS:	3 3/8" H x 1 7/8" W x 1 7/32" D (86mm x 47mm x 31mm)



ORDERING INFORMATION

CX-ED2071: 'UNIVERSAL' ELECTRIC STRIKE, 8 - 16V AC/DC, FAIL SAFE/FAIL SECURE OPERATION, HORIZONTAL ADJUSTMENT, C/W 3 STAINLESS STEEL FACEPLATES (CX-ESP1B, ESP3B & ESP4B)

CX-ED2079*: 'UNIVERSAL' ELECTRIC STRIKE, 12/24V AC/DC, FAIL SAFE/FAIL SECURE OPERATION, HORIZONTAL ADJUSTMENT, C/W 3 STAINLESS STEEL FACEPLATES (CX-ESP1B, ESP3B & ESP4B)

CX-ED2079-1*: 'UNIVERSAL' ELECTRIC STRIKE, 12/24V, AC/DC, FAIL SAFE/FAIL SECURE OPERATION, HORIZONTAL ADJUSTMENT, C/W 1 STAINLESS STEEL FACEPLATE (EX-ESP1B)

FACEPLATES

INCLUDED IN PACKAGE

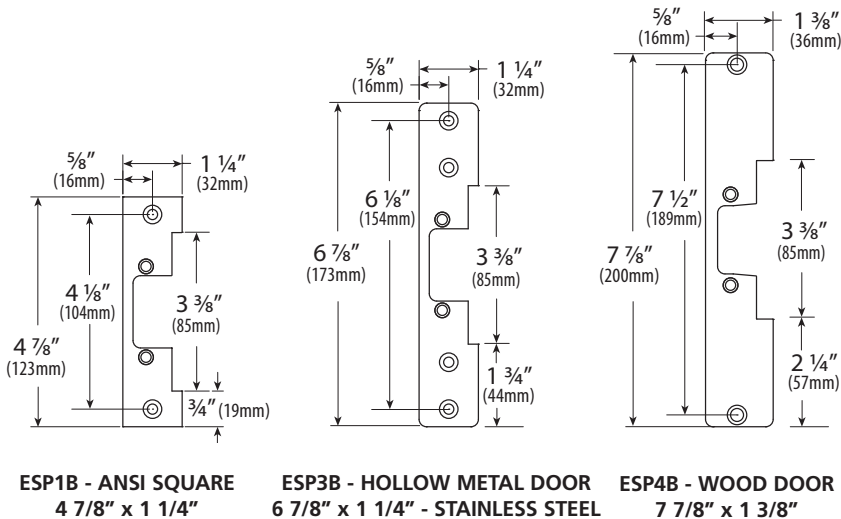

ADDITIONAL FACEPLATE

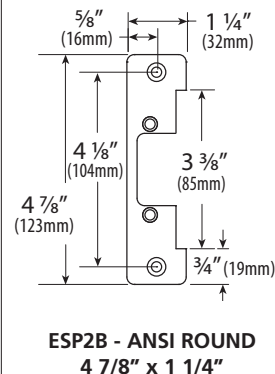

CX-JIG1



CX-ED-LIP1

CUTTING JIGS

CX-JIG1: JIG FOR INSTALLING ANSI ROUND FACEPLATES

CX-JIG2: JIG FOR HOLLOW METAL DOOR FACEPLATES

LIP EXTENSION BRACKETS

CX-ED-LIP1: 1" LIP EXTENSION FOR ANSI STRIKES (STACKABLE)

CX-ED-LIP2: 2" LIP EXTENSION FOR ANSI STRIKES