

SERIES 20 PRE LOAD STRIKES

CENTERLINE LATCH ENTRY, 1/2" - 5/8" LATCH PROJECTION (THROW)

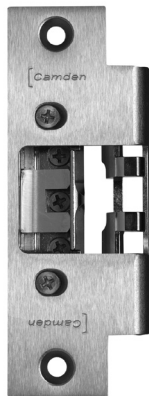

CX-EPD2000L



CX-EPD2850L

FEATURES

- PRE LOAD (FAIL SECURE ONLY)
AC 12-24V 20LBS. (9 KG.)
DC 12V 40LBS. (18 KG)
DC 24V 65LBS. (29.5 KG)
- EZ FIT™ 'NO CUT' MODEL CX-EPD2850L WITH BOTH VERTICAL AND HORIZONTAL FACEPLATE ADJUSTMENT
- STANDARD MODEL (CX-EPD2000L) OFFERS 4 FACEPLATE OPTIONS
- ADJUSTABLE KEEPER
- LATCH MONITORING, STANDARD
- STATIC STRENGTH 1,500LBS.
- SELECTABLE 12/24V AC/DC
- SELECTABLE FAIL SAFE/ FAIL SECURE
- REVERSIBLE FOR RIGHT OR LEFT HAND DOORS
- 5 YEAR LIMITED WARRANTY

DESCRIPTION

Camden Series 20 Pre Load electric strikes offer the highest pre load rating, 12/24V AC/DC operation, adjustable keeper, fail safe/fail secure operation, and latch monitoring. Latch cavity accommodates cylindrical locksets with 1/2" to 5/8" projection (1/8" door gap required) with a range of faceplates for installation in steel, aluminum and wood doors. EZ FIT™ CX-EPD2850L installs in a standard ANSI strike plate opening without the need to cut or drill the door frame. CX-EPD2850L also features horizontal and vertical faceplate adjustment.

DIMENSIONS

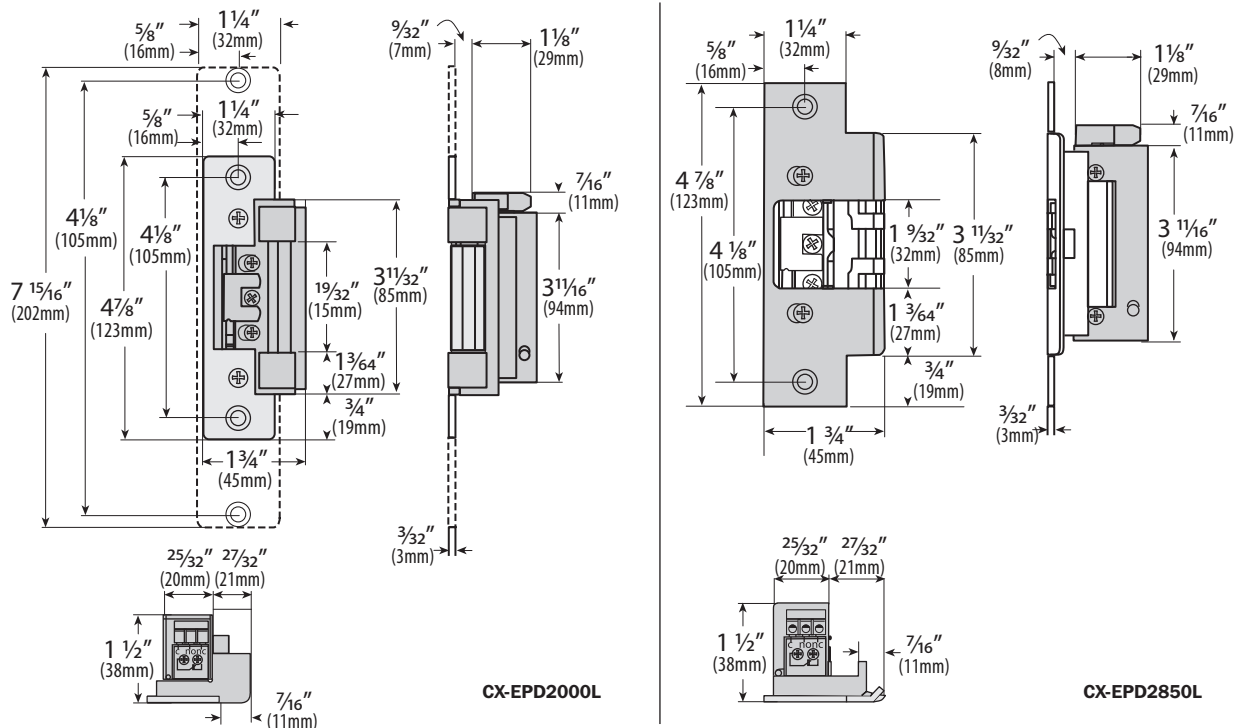

SERIES 20 PRE LOAD STRIKES

DOOR FRAME TYPES

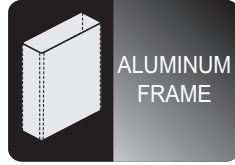
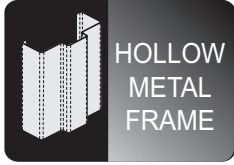

COMPATIBLE LOCKSETS



ORDERING INFORMATION

DESCRIPTION	MODEL	STRIKES COMPLETE WITH FACEPLATE			
		ANSI SQUARE 4 7/8" X 1 1/4"	ANSI ROUND 4 7/8" X 1 1/4"	HOLLOW METAL DOOR 6 7/8" X 1 1/4"	WOOD DOOR 7 15/16" X 1 1/4"
STANDARD BODY, FAIL SAFE/SEC, 12/24V AC/DC, LATCH MONITOR	CX-EPD2000L	CX-EPD2010L	CX-EPD2020L	CX-EPD2030L	CX-EPD2040L
EZ FIT™, FAIL SAFE/SEC, 12/24V AC/DC, LATCH MONITOR		CX-EPD2850L			

FACEPLATES

MODEL	DESCRIPTION
CX-ESP1	ANSI Square, 4 7/8" x 1 1/4", square corners
CX-ESP2	ANSI Round, 4 7/8" x 1 1/4", rounded corners
CX-ESP3	Hollow Metal Door, 6 7/8" x 1 1/4", rounded corners
CX-ESP4	Wood Door, 7 15/16" x 1 1/4", rounded corners

ESP1 - ANSI SQUARE

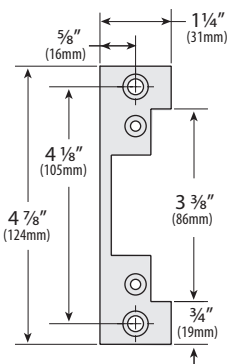

ESP2 - ANSI ROUND

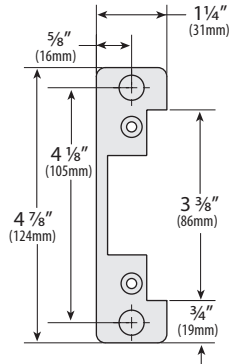

ESP3 - HOLLOW METAL DOOR

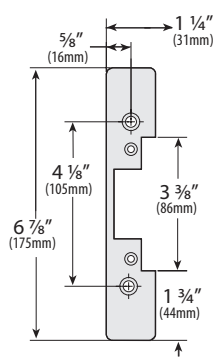

ESP4 - WOOD DOOR

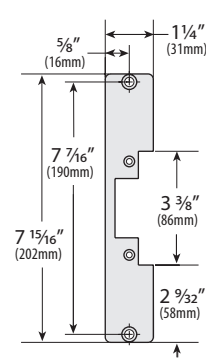

CROSS REFERENCE CHART

CAMDEN	RCI	ADAMS RITE	HES	ROFU	FOLGER ADAMS	VON DUPRIN	DYNALOCK
CX-EPD2000L	N/A	7400	7000	N/A	N/A	N/A	N/A