

SERIES 10
CENTERLINE LATCH ENTRY,
5/8" - 3/4" LATCH PROJECTION



SERIES 10



FEATURES

- BHMA GRADE 1
- FIELD SELECTABLE FAIL SECURE/FAIL SAFE
- DUAL VOLTAGE 12/24V AC OR DC
- UL 1034 BURGLARY-RESISTANT
- STATIC STRENGTH 1,500 LBS
- DYNAMIC STRENGTH 70 FT-LBS
- ENDURANCE RATING 250,000 CYCLES
- STRIKE DEPTH 1 1/2"
- LATCH MONITORING (OPTIONAL)
- FULLY REVERSIBLE FOR RIGHT OR LEFT-HAND DOORS
- CONTINUOUS DUTY OPERATION (DC)
- 5 YEAR WARRANTY
- FOUR FACEPLATE OPTIONS

DESCRIPTION

Designed for heavy-duty applications, the all-in-one SERIES 10 offers dual voltage and field selectable fail secure/fail safe operation. Deep latch cavity accommodates cylindrical locksets with a 5/8" to 3/4" throw (3/4" requires 1/8" door gap) in metal, wood or aluminum frames.

DIMENSIONS

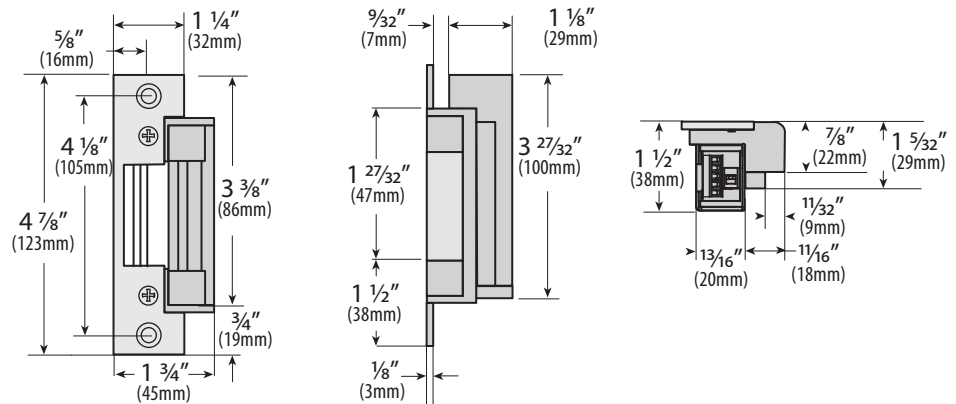

SERIES 10 ELECTRIC STRIKES

DOOR FRAME TYPES

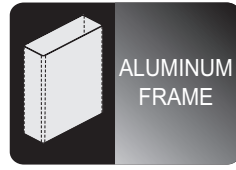
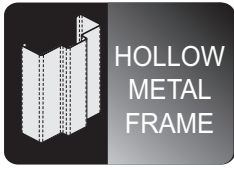

COMPATIBLE LOCKSETS



ORDERING INFORMATION

DESCRIPTION	MODEL	STRIKES COMPLETE WITH FACEPLATE			
		ANSI SQUARE 4 7/8" X 1 1/4"	ANSI ROUND 4 7/8" X 1 1/4"	HOLLOW METAL DOOR 6 7/8" X 1 1/4"	WOOD DOOR 7 15/16" X 1 1/4"
FAIL SAFE/FAIL SECURE VOLTAGE: 12/24V AC/DC AMPS .210 (12V), .105 (24V)	CX-ED1000	CX-ED1010	CX-ED1020	CX-ED1030	CX-ED1040
WITH LATCH MONITORING	CX-ED1000L	CX-ED1010L	CX-ED1020L	CX-ED1030L	CX-ED1040L

FACEPLATES

MODEL	DESCRIPTION
CX-ESP1	ANSI Square, 4 7/8" x 1 1/4", square corners
CX-ESP2	ANSI Round, 4 7/8" x 1 1/4", rounded corners
CX-ESP3	Hollow Metal Door, 6 7/8" x 1 1/4", rounded corners
CX-ESP4	Wood Door, 7 15/16" x 1 1/4", rounded corners

ESP1 - ANSI SQUARE

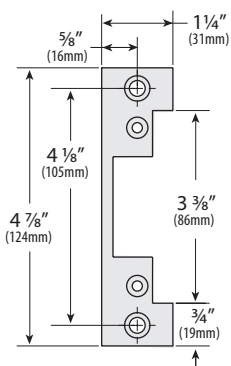

ESP2 - ANSI ROUND

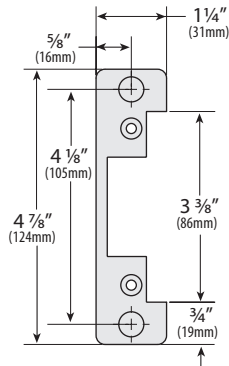

ESP3 - HOLLOW METAL DOOR

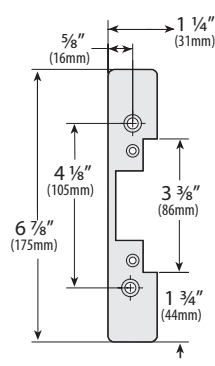

ESP4 - WOOD DOOR

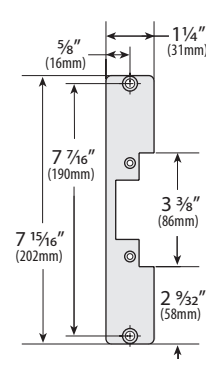

CROSS REFERENCE CHART

CAMDEN	RCI	ADAMS RITE	HES	ROFU	FOLGER ADAMS	VON DUPRIN	DYNALOCK
SERIES 10	6 SERIES	7160	5200 SERIES	2400 SERIES	N/A	5100 SERIES	1600 SERIES