

INSTRUCTION MANUAL

Intense-IR Camera

CVC5845DNV / CVC5845DNVW
CVC5945DNV / CVC5945DNVW



Contents

● Contents.....	1
● Precautions	2, 3
● Safety Instructions	4
● Package Contents.....	5
● Camera Installation	6-8
● Specifications.....	9, 10
● Camera Dimension	11
● OSD Menu Details	12-36
● Trouble Shooting.....	37

Precautions

Do not install the camera in extreme temperature conditions.

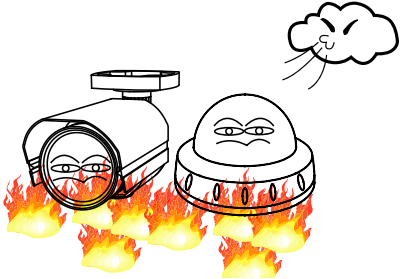

Only use the camera under conditions where temperatures are between -10°C and $+50^{\circ}\text{C}$. Be especially careful to provide ventilation when operating under high temperatures.

Do not install the camera under unstable lighting conditions.

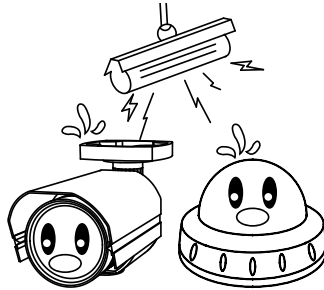

Severe lighting change or flicker can cause the camera to work improperly.

Do not touch the front lens of the camera.

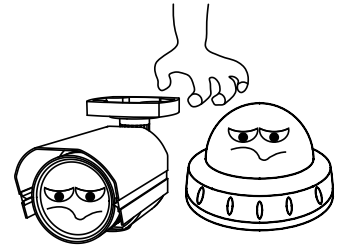

This is one of the most important parts of the camera. Be careful not to leave fingerprints on the lens cover.

Never keep the camera pointed directly at strong light.

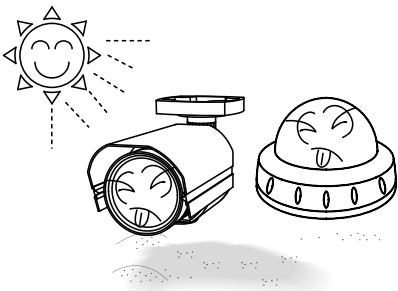

It can cause malfunctions to occur.

Do not drop the camera or subject it to physical shocks.

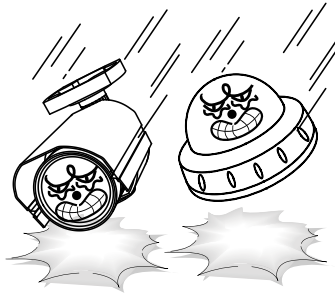

Housing damage can compromise weatherproof ratings.

Do not expose the camera to radioactivity.

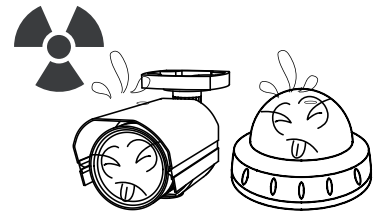

If exposed to radioactivity the CCD will fail.

NOTE

* If the camera is exposed to spotlight or object reflecting strong light, smear or blooming may occur.

* please check that the power satisfies the normal specification before connecting the camera.



The lightning flash with an arrowhead symbol, within an equilateral triangle is intended to alert the user to the presence of uninsulated dangerous voltage within the product's enclosure that may be of sufficient magnitude to constitute a risk of electric shock to persons.



The exclamation point within an equilateral triangle is intended to alert the user to the presence of important operating and maintenance (servicing) instructions in the literature accompanying the appliance.

INFORMATION - This equipment has been tested and found to comply with limits for a Class A digital device, pursuant to part 15 of the FCC Rules & CE Rules. These limits are designed to provide reasonable protection against harmful interference when the equipment is operated in a commercial environment. This equipment generates, uses, and can radiate radio frequency energy and, if not installed and used in accordance with the instruction manual, may cause harmful interference to radio communications. Operation of this equipment in a residential area is likely to cause harmful interference in which case the user will be required to correct the interference at his own expense.

WARNING - Changes or modifications not expressly approved by the manufacturer could void the user's authority to operate the equipment.

CAUTION : To prevent electric shock and risk of fire hazards:
⚠ Do NOT use power sources other than those specified.

This installation should be made by a qualified service person and should conform to all local codes.

Safety Instructions

Precautions for use

- ❶ This camera should be installed by qualified personnel only
- ❶ There are no user serviceable parts inside
- ❶ Do not disassemble this camera other than to make initial adjustments
- ❶ Use a UL approved regulated 24 volt AC or 12 volt DC power supply
- ❶ Use appropriate low voltage power cable to prevent fire or electrical shock
- ❶ Please insure that your installation area can support the weight of the camera

Please handle this camera carefully :

- ❶ Do not use a strong or abrasive detergent when cleaning the camera
- ❶ Do not install near cooling or heating device

Package Contents

Please make sure that the following items are included in the Package:

- 1) CVC5845DNV, CVC5845DNVW, CVC5945DNV, CVC5945DNVW
 - 1 Video Test Connector, Power Jack
 - 2 Wrenches
 - Set Screw
 - 3 Tapping Screws 4x25
 - 2 Hexagon Socket Screws M6x20

CAMERA INSTALLATION

CONNECT POWER CABLE

1. WHEN USING 12 VOLTS DC (constant voltage 500 mA)

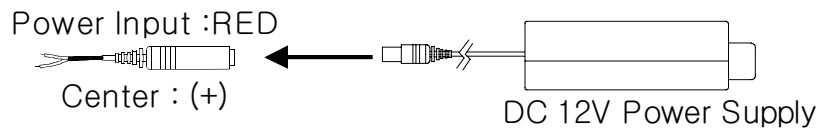

2. WHEN USING 24 VOLTS AC (40 Volt Amps)

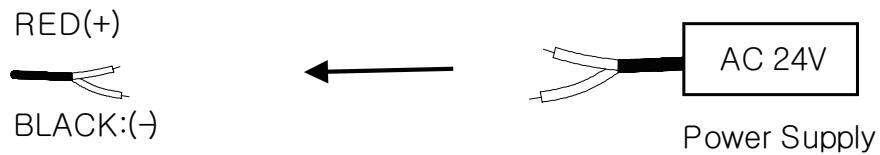

3. CONNECT VIDEO CABLE

- CONNECT BNC CABLE TO THE BNC JACK.

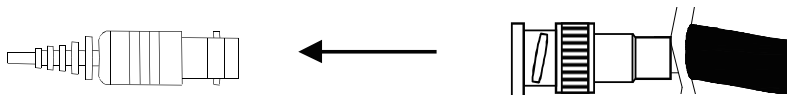

CAMERA INSTALLATION

Compatibility

1) CVC5845DNV, CVC5845DNVW, CVC5945DNV, CVC5945DNVW

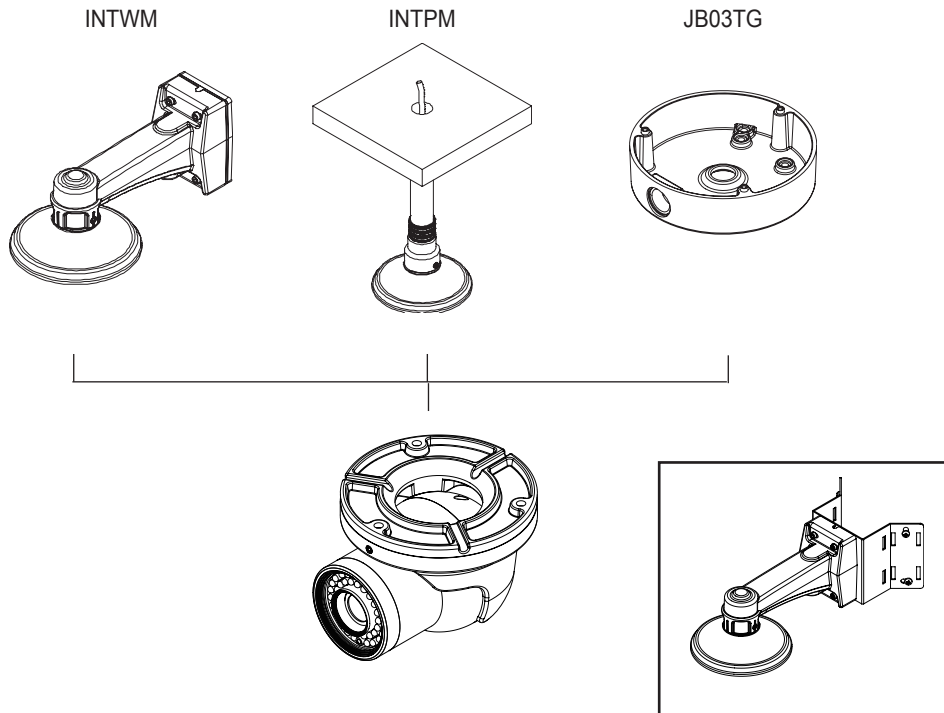

CAMERA INSTALLATION

1. CVC5845DNV, CVC5845DNVW, CVC5945DNV, CVC5945DNVW

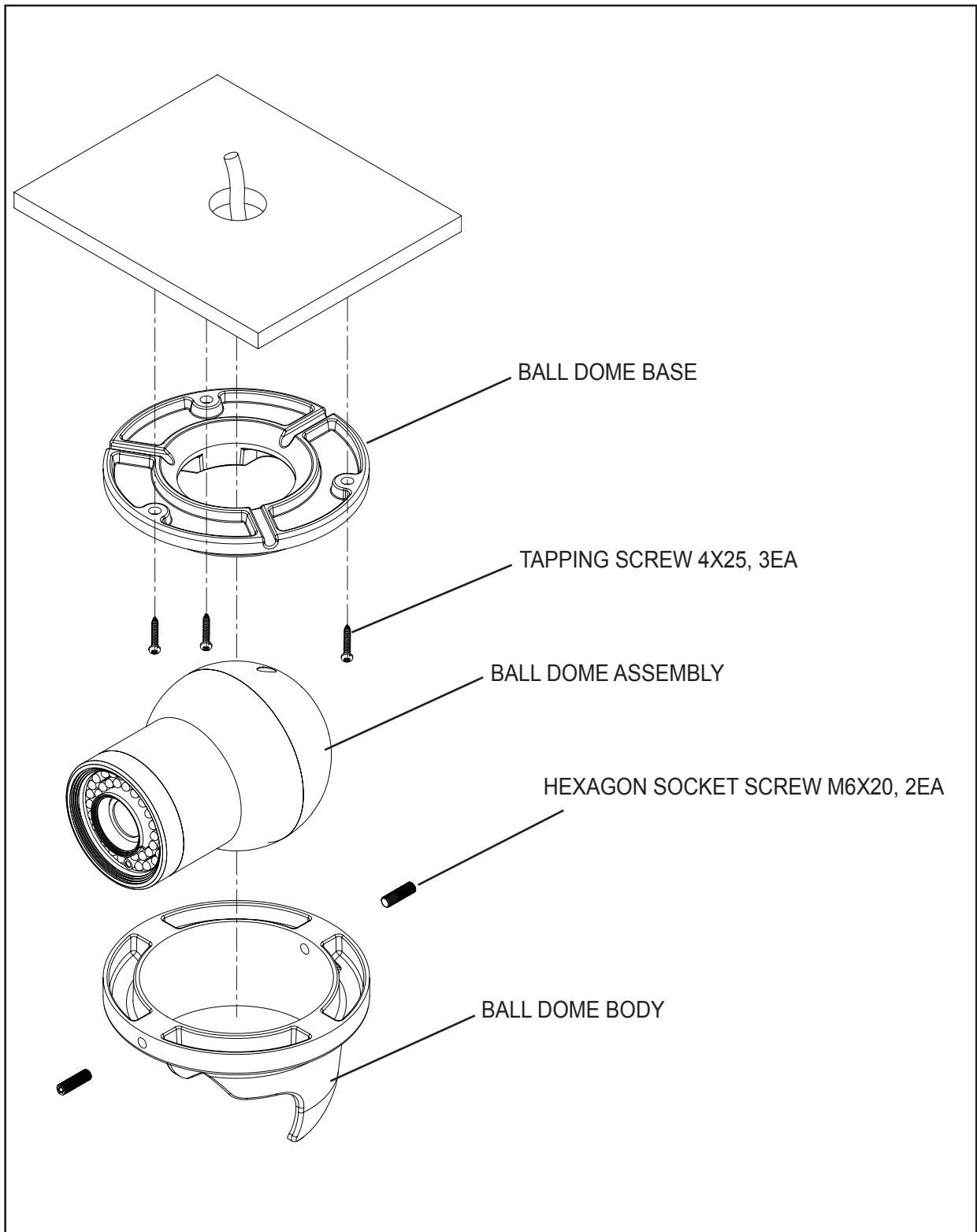

Intense - IR Vandal Dome Camera

DC Auto Iris Varifocal Lens(2.8mm-12mm) / IR LED Built-in 42 pcs



- CVC5845DNV
- CVC5845DNVW
- 600TV Lines
- DC Auto Iris Varifocal Lens (2.8mm-12mm)
- True Day/Night Capability
- ICR-IR Cut Filter Removable
- 850nm IR LEDs x 42pcs

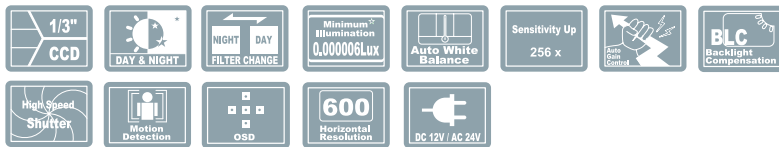

SPECIFICATIONS

MODEL	CVC5845DNV / CVC5845DNVW
Sensor	1/3" SONY Super HAD II CCD
Total Pixels	NTSC=811(H) * 508(V) / PAL=795(H) * 595(V)
Effective Pixels	NTSC=768(H) * 494(V) / PAL=752(H) * 582(V)
Scanning System	2:1 Interlace
Synchronization	Internal / Line Lock(Optional)
O.S.D	Available
Backlight	OFF / HSBLC / BLC Selectable
Resolution	600TV Lines
S/N (Y signal)	52dB (AGC Off, Weight On)
Min. Illumination	0.000006 Lux(IR LED ON)
White Balance	ATW / AWB / Manual / AWC →SET
Electronic Shutter Speed	1/50sec, 1/60sec ~ 1/100,000sec
Sense-Up	Off / Auto(Selectable limit *2 ~ *256)
Gain Control	High, Middle, Low, Off Selectable
3 DNR	Off/On (1~50 Level Adjustable)
D-WDR	Indoor / Outdoor / Off
Motion Detection	On/Off (4 Zone)
Privacy	On/Off (8 Zone)
Mirror	Off / Mirror / V-Rev / Rotate
Freeze	On/Off
Sharpness	0~31'(Level Adjustable)
D&N Selection	Color /BW/ Auto/ EXT
Digital Zoom	On(*32) / Off
Blemish Compensation	Auto:128 Point / Manual:4 Point
Power	DC 12V / AC24V(Dual Voltage)
Power Consumption	DC 12V 250mA(CDS OFF) / 750mA(CDS ON)
	Heater ON Adj:280~750mA
	AC 24V 100mA(CDS OFF) / 270mA(CDS ON)
Power Consumption	Heater ON Adj:120~270mA
	DC Auto Iris Varifocal Lens(2.8mm-12mm)
Lens	DC Auto Iris Varifocal Lens(2.8mm-12mm)
IR Distance	98 ft
Operating Temperature/Humidity	-4°F ~ +140°F RH 95% Max.
Storage Temperature/Humidity	-4°F ~ +140°F RH 95% Max.
Dimension	5.47" (Dia) * 4.36" (H)
Weight	3.08 lbs

Intense - IR Vandal Dome Camera

DC Auto Iris Varifocal Lens(5mm-50mm) / IR LED Built-in 42 pcs



- CVC5945DNV
- CVC5945DNVW
- 600TV Lines
- DC Auto Iris Varifocal Lens (5mm-50mm)
- True Day/Night Capability
- ICR-IR Cut Filter Removable
- 850nm IR LEDs x 42pcs

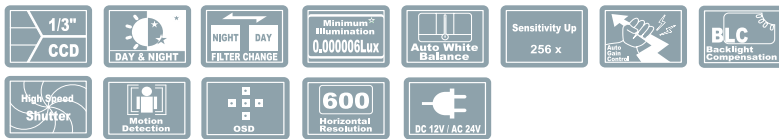

SPECIFICATIONS

MODEL	CVC5945DNV / CVC5945DNVW
Sensor	1/3" SONY Super HAD II CCD
Total Pixels	NTSC=811(H) * 508(V) / PAL=795(H) * 595(V)
Effective Pixels	NTSC=768(H) * 494(V) / PAL=752(H) * 582(V)
Scanning System	2:1 Interlace
Synchronization	Internal / Line Lock(Optional)
O.S.D	Available
Backlight	OFF / HSBLC / BLC Selectable
Resolution	600TV Lines
S/N (Y signal)	52dB (AGC Off, Weight On)
Min. Illumination	0.000006 Lux(IR LED ON)
White Balance	ATW / AWB / Manual / AWC →SET
Electronic Shutter Speed	1/50sec, 1/60sec ~ 1/100,000sec
Sense-Up	Off / Auto(Selectable limit *2 ~ *256)
Gain Control	High, Middle, Low, Off Selectable
3 DNR	Off/On (1~50 Level Adjustable)
D-WDR	Indoor / Outdoor / Off
Motion Detection	On/Off (4 Zone)
Privacy	On/Off (8 Zone)
Mirror	Off / Mirror / V-Rev / Rotate
Freeze	On/Off
Sharpness	0~31'(Level Adjustable)
D&N Selection	Color /BW/ Auto/ EXT
Digital Zoom	On(*32) / Off
Blemish Compensation	Auto:128 Point / Manual:4 Point
Power	DC 12V / AC24V(Dual Voltage) DC 12V 250mA(CDS OFF) / 750mA(CDS ON) Heater ON Adj:280~750mA
Power Consumption	AC 24V 100mA(CDS OFF) / 270mA(CDS ON) Heater ON Adj:120~270mA
Lens	DC Auto Iris Varifocal Lens(5mm-50mm)
IR Distance	98 ft
Operating Temperature/Humidity	-4°F ~ +140°F RH 95% Max.
Storage Temperature/Humidity	-4°F ~ +140°F RH 95% Max.
Dimension	5.47"(Dia) * 4.36"(H)
Weight	3.08 lbs

CAMERA DIMENSION

1) CVC5845DNV, CVC5845DNVW, CVC5945DNV, CVC5945DNVW

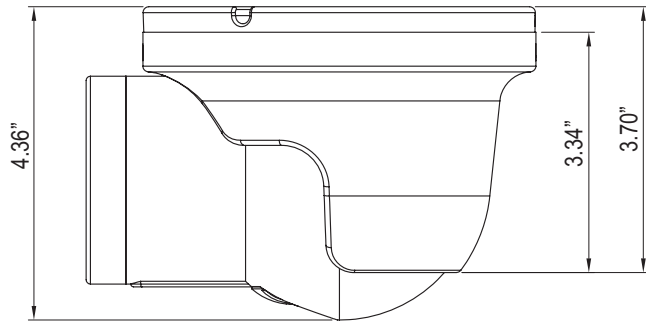
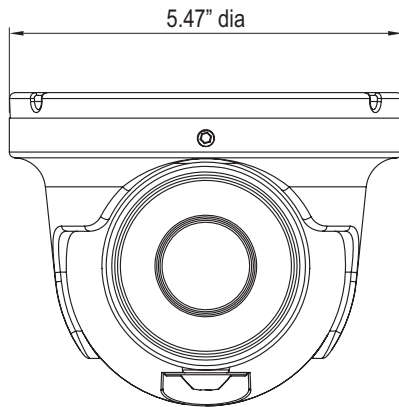

OSD Control Button

1. Type A, Type B, Type C of OSD button could be used when it needs to OSD control.
2. Type D is extra Option (wired Remote controller)

Type A

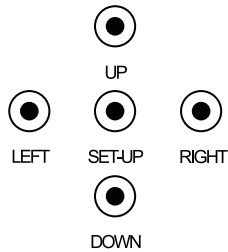

Type.B

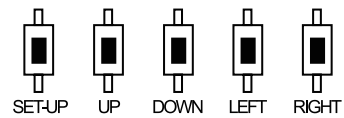

Type C

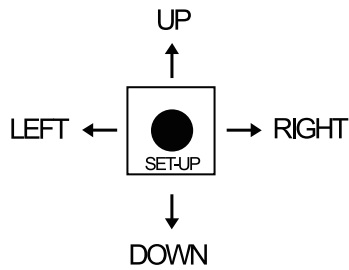

Type D (Option)

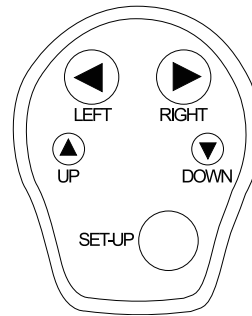

How to Set Up the camera menu

● Setup Menu

SET UP MENU	DEFAULT SET	MENU						
LENS	DC	BRIGHTNESS (0~100 Adjustable)						
		RETURN	RET					
	MANUAL		END					
EXPOSURE	SHUTTER	AUTO, 1/60, 1/50, FLK, 1/250, 1/500, 1/1000, 1/2000, 1/5000, 1/10000, 1/100000, x256, x128, x64, x32, x16, x8, x4, x2						
	AGC	OFF						
		LOW						
		MIDDLE						
		HIGH						
	SENSE-UP	AUTO	SENSE-UP(x2 ~ x256 Level Selectable)					
			RETURN	RET	END			
	BLC	BLC	OFF					
			GAIN	LOW				
				MIDDLE				
				HIGH				
				POSITION				
			AREA	SIZE				
				AGAIN				
				DEFAULT				
			RETURN	RET		END		
			HSBLC	HSBLC	LEVEL		0~8 Selectable	
					MODE		ALL DAY NIGHT ONLY	
					AREA	POSITION		
						SIZE		
						AGAIN		
	DEFAULT							
	RETURN	RET		END				
D-WDR	INDOOR	LOW-LEVEL (0 ~15 Adjustable)						
		HIGH-LEVEL (0 ~15 Adjustable)						
		RETURN	RET	END				
	OUTDOOR	LOW-LEVEL (0 ~15 Adjustable)						
		HIGH-LEVEL (0 ~15 Adjustable)						
		RETURN	RET	END				
RETURN	RET		END					
WHITE BAL	ATW							
	AWB							
	AWC->SET							
	MANUAL	BLUE (0 ~100 Level Selectable)						
		RED (0 ~100 Level Selectable)						
	RETURN	RET		END				
INDOOR								
OUTDOOR								

DAY/NIGHT	COLOR			
	AUTO	DELAY (0 ~63 Adjustable)		
		D->N(AGC) (48 ~208 Adjustable)		
		N->D(AGC) (0 ~160 Adjustable)		
		RETURN	RET	
			END	
	EXT			
B/W	BURST	ON/OFF		
	IR SMART	ON	GAIN	
			AREA	
			RETURN (RET/END)	
	OFF			
3DNR	ON	LEVEL (RANGE 0 ~100 Level Selectable)		
		RETURN	RET	
			END	
	OFF			
SPECIAL	CAM TITLE	ON/OFF		
	D-EFFECT	FREEZE	ON/OFF	
		MIRROR	MIRROR	
				V-FLIP
				ROTATE
				OFF
	D-ZOOM	ON	D-ZOOM (x1 ~ x32)	
			PAN (-100 ~ 100)	
			TILT (-100 ~ 100)	
			RETURN (RET/END)	
		NEG. IMAGE	ON/OFF	
		RETURN	RET	
			END	
	RS485 (OPTION)	CAM ID		
		ID DISPLAY	ON/OFF	
		BAUDRATE		
		RETURN	RET	
			END	
	MOTION	ON	AREA SELECT (AREA1 ~ AREA4)	
			AREA DISPLAY	POSITION
				SIZE
				AGAIN
			SENSITIVITY (0 ~ 40)	
		MOTION VIEW	ON/OFF	
		RETURN	RET	
		END		
	OFF			
PRIVACY	ON	AREA SELECT		
		AREA DISPLAY	POSITION	
			SIZE	
			AGAIN	
		COLOR		
	RETURN	RET		
		END		
	OFF			
SYNC (OPTION)	INT			
	L/L			

	DEFECT	SENSE-UP (x4 ~ x64)		
		DIFFERENCE (1 ~6)		
		START		
	RETURN	RET		
		END		
RETURN	RET			
	END			
ADJUST	SHARPNESS	0 ~31 Level Adjustable		
	MONITOR	CRT	LEVEL (0 ~63)	
			BLUE GAIN (0 ~100)	
			RED GAIN (0 ~100)	
		RETURN	RET	
			END	
		LCD	GAMMA (USER ~ 1.00)	
	LEVEL (0 ~63)			
	BLUE GAIN (0 ~100)			
		RED GAIN (0 ~100)		
	RETURN	RET		
		END		
	USER	GAMMA (USER ~ 1.00)		
		LEVEL (0 ~63)		
		BLUE GAIN (0 ~100)		
RED GAIN (0 ~100)				
	RETURN	RET		
		END		
RETURN	RET			
	END			
RESET	FACTORY	RESET		
	RETURN	RET		
		END		
EXIT				

Menu Set Up

Menu items can be selected by using the OSD buttons of the camera

1. Press the Set Up button.

* The Set Up menu will be displayed on the monitor.

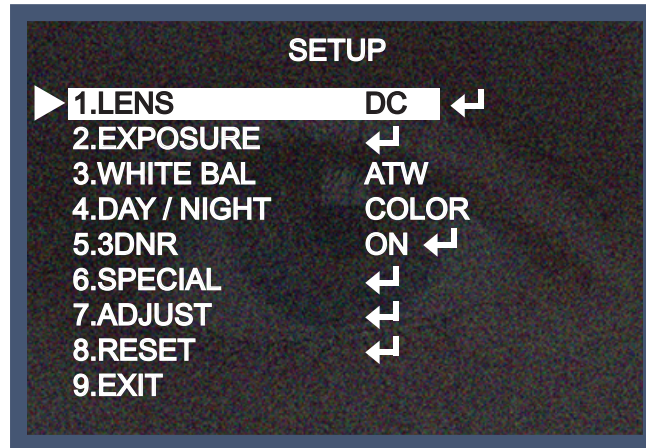

2. Move and select the required function using the Up and Down button.

* Move the arrow indicator Up or Down to select the desired feature by pressing the Up or Down button.

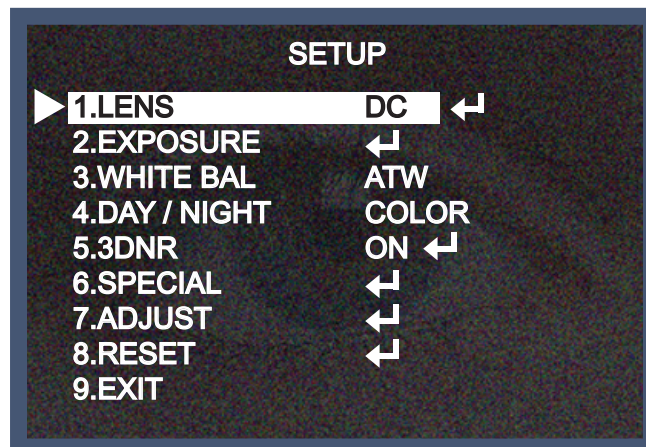

3. Change menu settings using the Left or Right button.

* Available values or Status are displayed by pressing the Left or Right buttons.
Press the button until desired value / status is displayed.

4. After Changing the setting move the arrow indicator to EXIT and press the SET button to EXIT.

NOTE

- * Move to the available submenu by moving  arrow to desired feature.
- * Submenu is not available when this symbol is display "----"

Lens

1. Move the arrow indicator to LENS using the Up and Down buttons on the Set Up menu screen.
2. Select the desired lens type by pressing the Left or Right button.

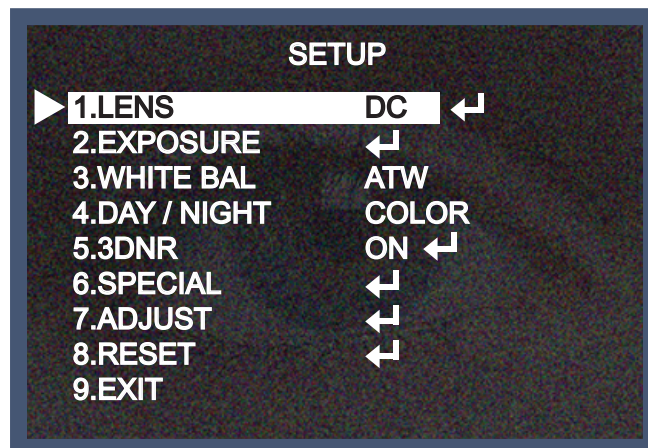

 DC:DC Auto Iris Lens

NOTE

* When DC is selected, the brightness can be adjusted. The brightness control range is 1 ~ 100.

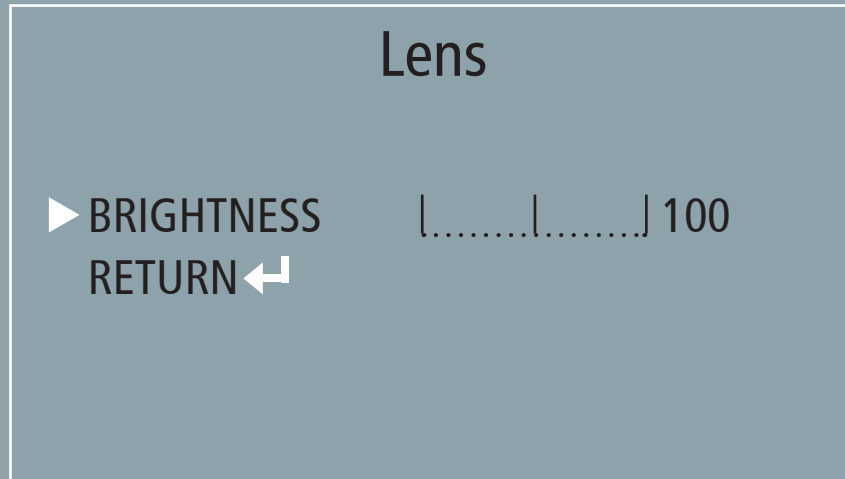

3. Press the RETURN to return to the SETUP menu.

Exposure

This function is used to select Automatic or Manual shutter speed control.

1. On the Set Up menu screen select EXPOSURE by using the Up or Down button.
2. Select the desired shutter mode by pressing the Left or Right button.

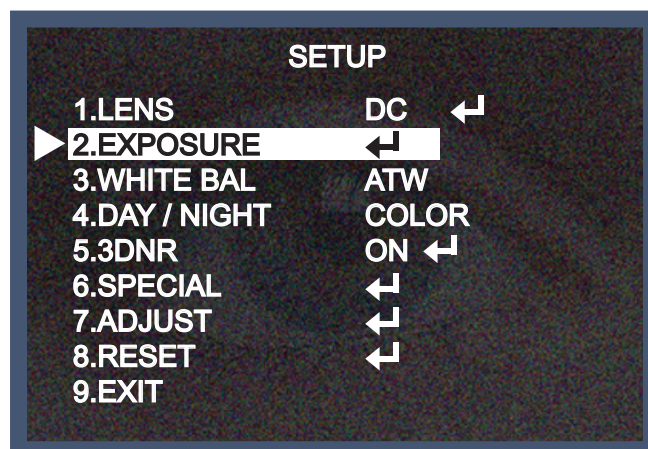

* FLK : Select FLK mode when flickering occurs; caused by the unmatched frequency of electric lights.

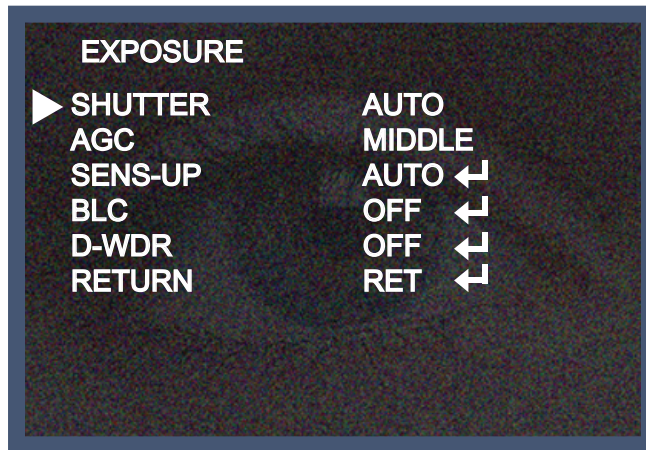

NOTE

*Shutter: Select Shutter using the Up or Down button, you can adjust the shutter speed from 1/60, FLK, 1/250~1/100,000.

→FLK: Select FLK mode if flickering occurs; caused by the unmatched frequency of electric light. If select FLK mode, sense-up does not operate.

* AGC(AUTO GAIN CONTROL):

A higher gain increases brightness but also increases any noise.

OFF : Deactivates the AGC function

LOW : Sets automatic gain control to LOW.

MIDDLE : Sets automatic gain control to MIDDLE.

HIGH : Sets automatic gain control to HIGH

* SENS - UP:

At night and/or in dark conditions, the Sens-Up mode can be selected to desired value from x2 ~ x256.

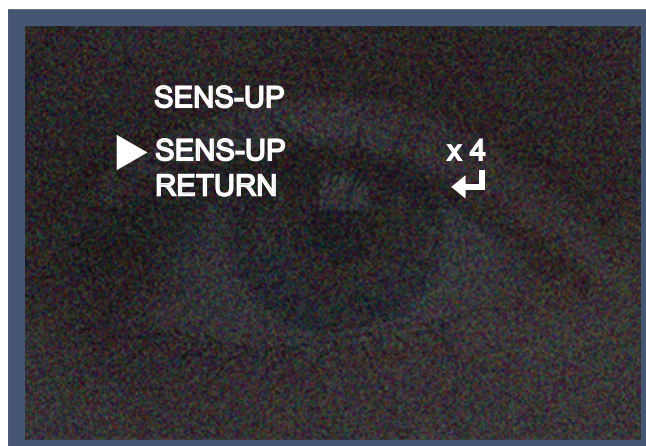

* RETURN:

Select Return to save the changes in the EXPOSURE menu and return to the SETUP menu.

NOTE

- * Pressing the SET button in AUTO mode allows adjustment of image brightness by increasing or decreasing the shutter speed (x2 ~x256).
- * The higher the level, the brighter the image becomes, but it is possible that an after image (ghosting) could appear.
- * When SENS-UP is activated the increased magnification can induce noise and pixelation; this is quite normal.

Back Light(BLC)

This camera which is using 3D-DNR DSP provides intelligent light level control to overcome even strong backlight conditions.

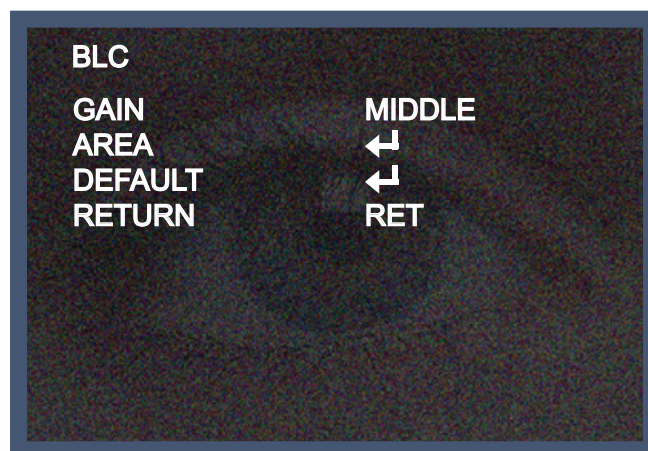

* OFF: BLC function does not operate.

* BLC: Select LOW/MID/HIGH

User can select and define a specific area in scene and view the area clearly.

Press the "ENTER" button at the AREA menu, you can change the area like a picture 1.

Press the "ENTER" button again after area setting, you can change the area like a picture 2.

Default: Press the Default to return to factory defaults.

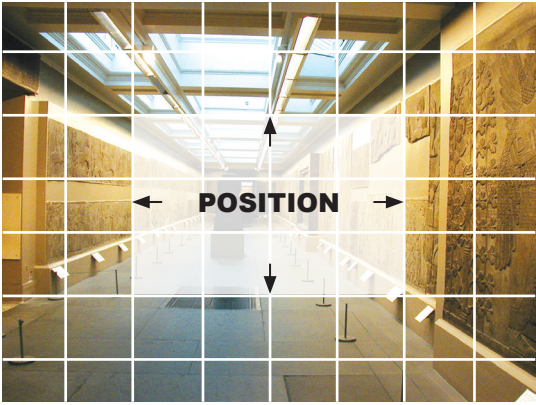

PICTURE 1

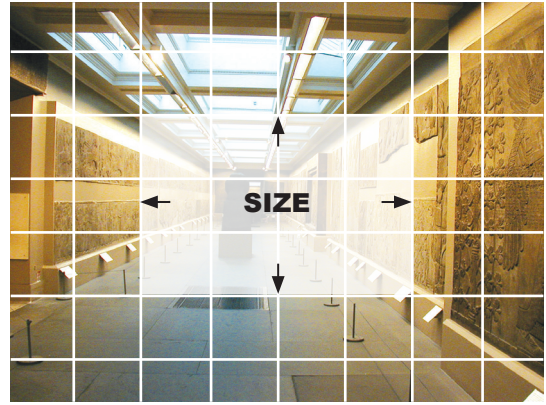

PICTURE 2

* HSBLE: HSBLC function is especially effective for reading car number plates at the night time.

You can select and define the required observation area for the target object and ignore a strong light area.

Press the "ENTER" button at the AREA menu, you can change the position as shown in Picture 1.

Press the "ENTER" button again after area setting, you can change the position as shown in Picture 2.

Default: Press the Default to return to factory defaults.

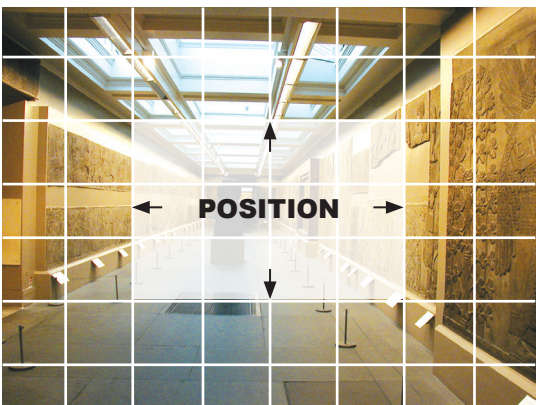
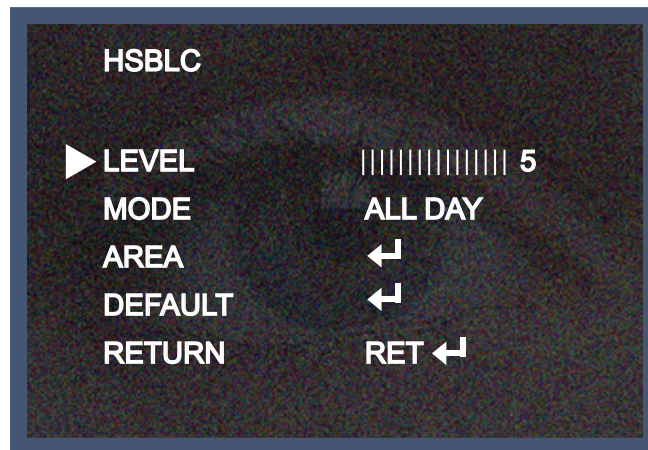

PICTURE 1



PICTURE 2



HSBLC OFF



HSBLC ON

* D-WDR: This camera which is using 3D-DNR DSP provides intelligent light level control to overcome even strong backlight conditions.

→OFF: D-WDR function does not operate.

When there are simultaneous bright & dark image area WDR makes them both distinct and can be selected as OUTDOOR and INDOOR.



D-WDR OFF



D-WDR ON

* RETURN: Select Return to save the changes in the EXPOSURE menu and return to the SETUP menu.

White Balance

The White Balance function is used to control the "on-screen" colors.

1. Move the arrow indicator to WHITE BAL on the SETUP menu screen using the Up and Down button.
2. Select the desired mode by using the Left or Right button.

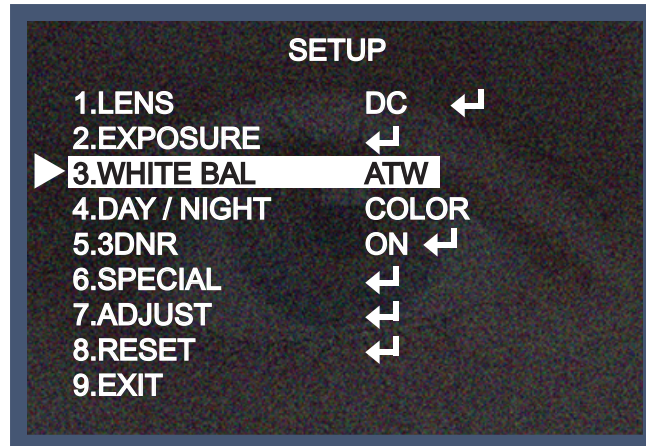

* **There are three user selectable White Balance settings available.**

* ATW : (Auto Tracking White Balance)

Normal setting; when the color temperature range is from 1,800°K to 10,500°K. (Ex: a fluorescent lamp or outdoors)

* AWB : The White Balance is automatically adjusted in a specific environment.

* AWC → SET : To obtain the best results press the SET button while the camera is focused onto white paper. If the environment, and/or light source changes, the White Balance will require re-adjustment.

* MANUAL : Used for fine adjustment of White Balance. Set White Balance first using ATW or AWC then change to MANUAL and press SETUP button. Increase or decrease the value of R-Gain(Red) and B-Gain(Blue) while monitoring the color of the image.

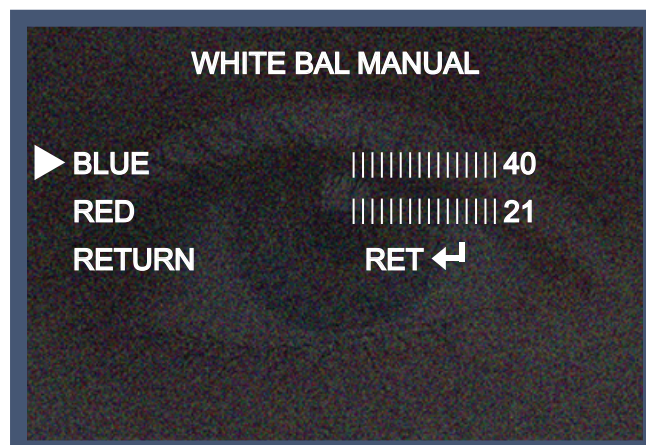

Day / Night

Picture can be displayed in either colour of black and white.

1. Select DAY / NIGHT using the Up or Down button on the SETUP menu screen.

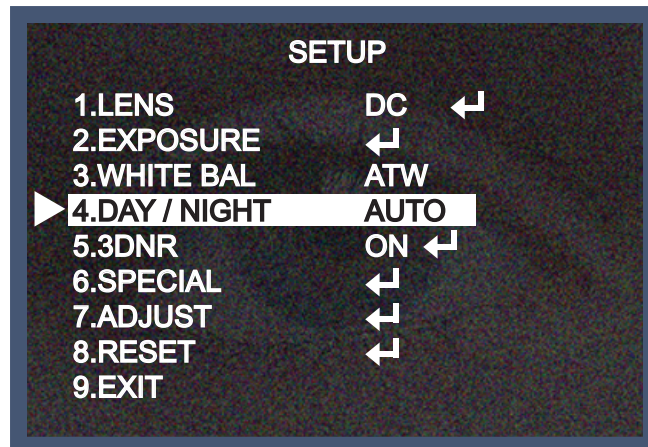

2. Select the desired mode using the Left and Right buttons.

* COLOR : The picture is always displayed in color.

* BW : This picture is always displayed in black and white.

Select BW using the button and press the menu to activate COLOR BURST option.

IR SMART : It controls the IR LED(bright portion base), saturation is not expected.

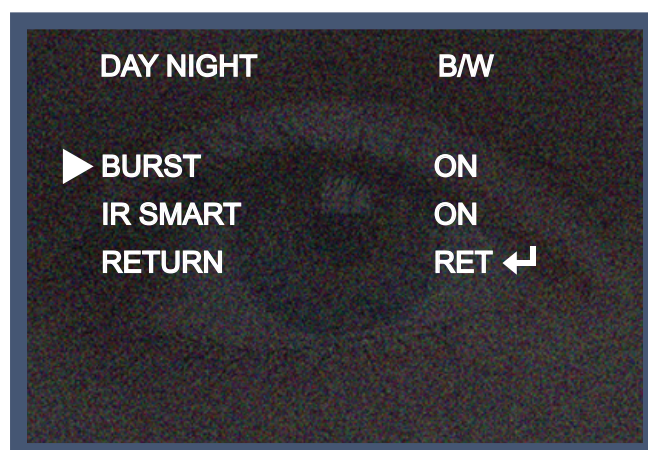

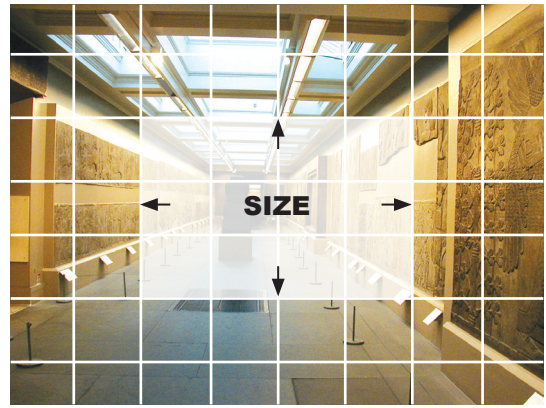
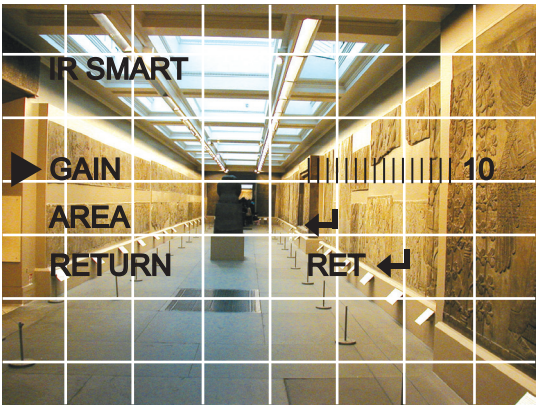

AREA



SMART IR OFF



SMART IR ON

→ AUTO: The mode will automatically switches to COLOR in normal condition and switches to BW mode when ambient illumination is low.

Press the SET button to set the switching time or D→N(AGC), N→D(AGC) in AUTO mode.

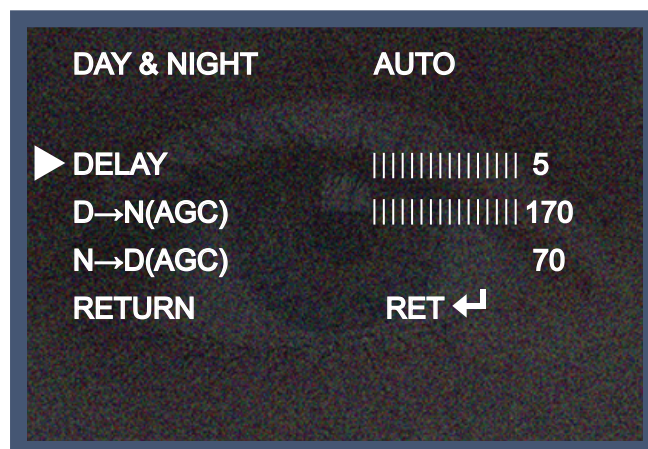

3DNR

3DNR is used to reduce the level of background noise in a low luminance environment.

1. Move the arrow indicator to 3DNR by using the Up and Down button.

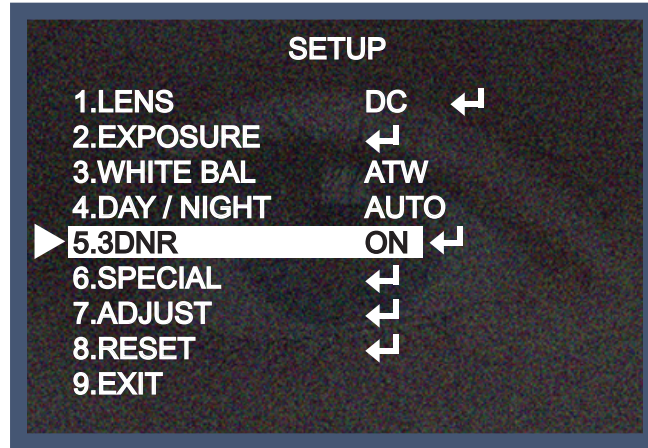

2. Select whether or not to activate 3DNR by using the Left and Right buttons.

* ON: Activates 3DNR - Digital noise reduction can be adjusted between 0 ~ 100.

* OFF: Deactivates 3DNR - noise is not reduced.



* Select RETURN by using the Up or Down button to return to Set Up menu.

Special

When the SETUP menu screen is displayed, select SPECIAL using the Up and Down buttons.

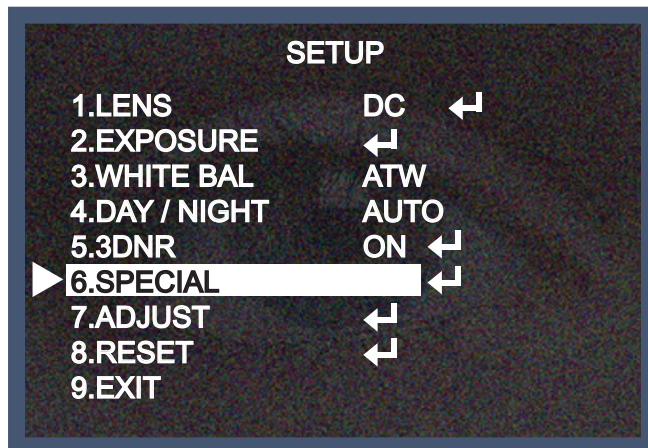

Select one of the mode using the Up and Down button.

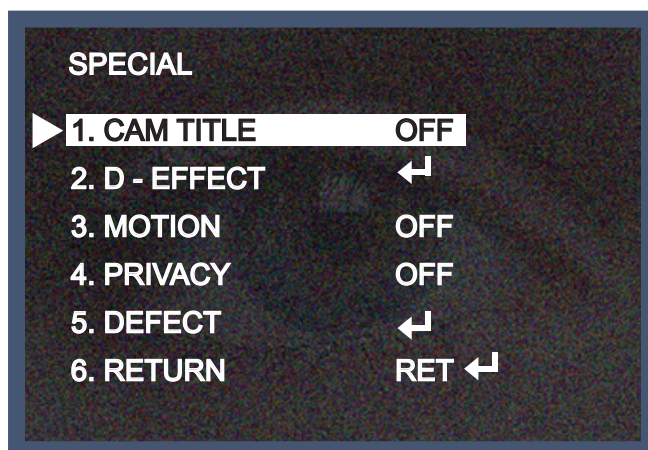

1. CAM TITLE : When input, the Camera ID is displayed on the monitor.

1-1) Move the arrow indicator to CAMERA ID using the Up or Down button on the SETUP menu screen.

1-2) Set to ON using the Left or Right button.

NOTE

* When CAMERA TITLE is set to OFF, the CAMERA TITLE is not displayed on the monitor.

1-3) Press the SETUP button.



1-4) The CAMERA TITLE can be up to 15 alphanumeric characters in length.

① Move the cursor to choose an alphanumeric character.



② Choose a character in displayed range A~Z, a~z, 0~9 using the Up, Down, Left and Right buttons.

③ Select the desired character by pressing the SETUP button.

- The cursor moves to the next position, after character input, by pressing the SETUP button.

④ Repeat the above steps until the Camera ID has been created.

NOTE

* In cases where the wrong Camera ID has been input.....

Move the cursor to CLR and press SETUP button to erase characters from left to right, and repeat the above steps to input the characters again.

1-5) To select the position where the Camera ID should be displayed on the screen.

① Move the cursor to POS and press the SET button.



② Created camera ID is displayed.

(Factory default position)



③ Select a new position by using the four directional button, Press the SET button to confirm the position.



2. D - EFFECT

Move the cursor to D-EFFECT and press the SET button to set the other image functions.

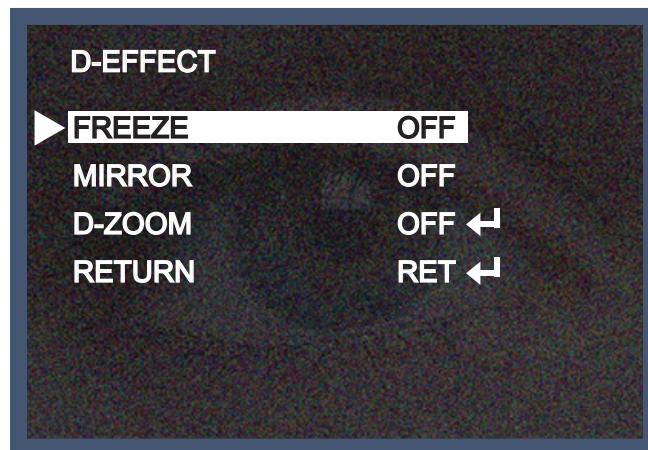

2 -1) MIRROR : Flip the image horizontally on the screen.

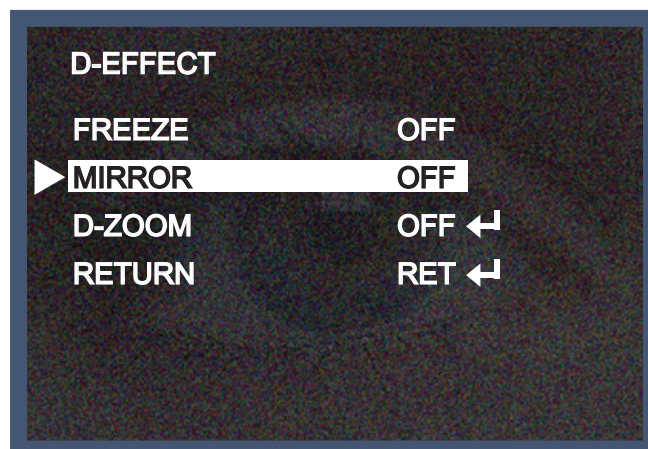

- * V-FLIP : Flip the image vertically on the screen.
- * ROTATE : Flip the horizontal image vertically on the screen.
- * OFF : Disabled.



MIRROR ON



MIRROR OFF

- 2-2) D - ZOOM: Digital zoom available, range x1 ~ x32.
- PAN : The pan range can be controlled between -10 ~ + 100
- TILT : The tilt range can be controlled between -10 ~ + 100

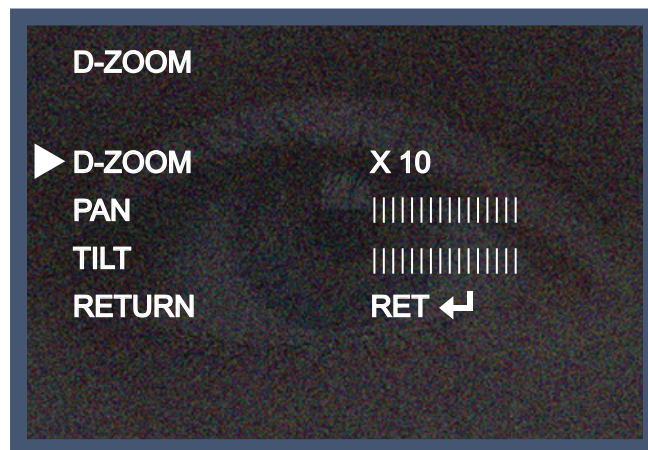

NOTE

* PAN and TILT function should be available when using the digital zoom.

2-3) GAMMA : Desired gamma values can be adjusted between 0.05 ~ 1.00.

2-4) NEG. IMAGE :

ON : Activates negative image just like film

OFF : Normal image

2-5) RETURN : Move the arrow indicator to RETURN after complete the setup to return to SPECIAL menu.

3. MOTION

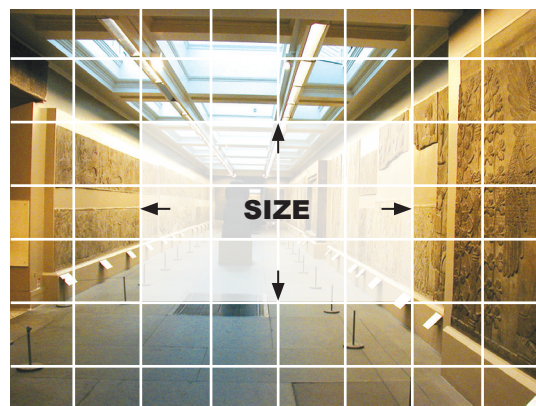
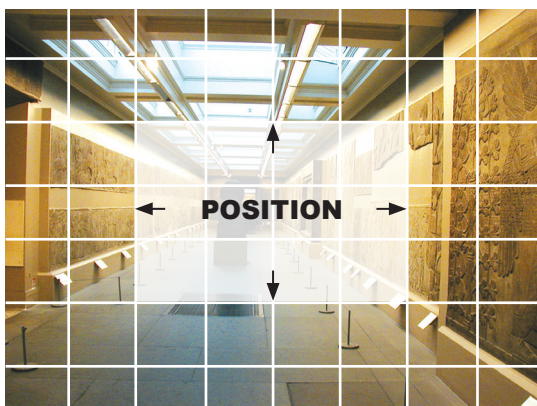
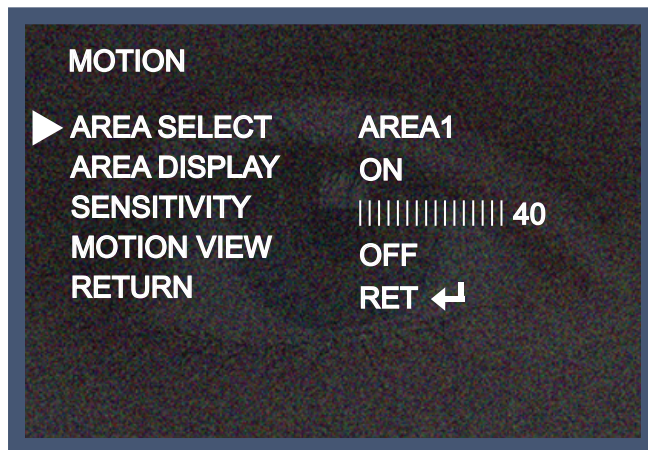

3-1) When the special menu screen is displayed, use the Up or Down button to access the MOTION menu.

AREA SELECT : You can select from area 1~4 position.

AREA DISPLAY) ON: Display the Motion Detected area on the screen. You can set the location and size like picture 1,2.

SENSITIVITY: To setup the motion sensitivity. You can adjust the motion sensitivity of a movement between level 0~40.

MOTION VIEW : If camera detects movement, the words of "MOTION DETECTION" will appear on the monitor.

RETURN : To return to the SPECIAL menu after completing the setup.

4. PRIVACY

Hide an area you want to hide on the screen.

4-1). When the SPECIAL menu screen is displayed, press the Up and Down buttons to set to PRIVACY.

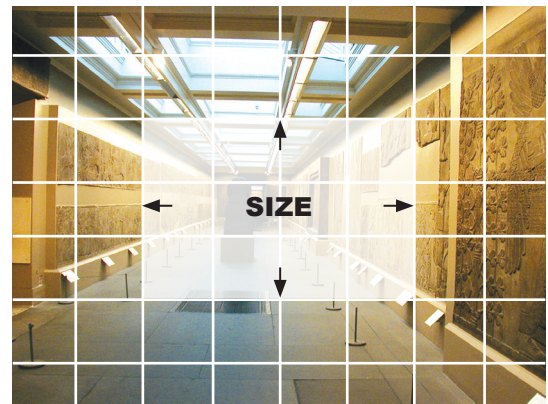

4-2). Set up the area mode using the 4 direction buttons.

① AREA SELECT : You can select up to 8 MD area.

② AREA DISPLAY : OFF : Disabled

ON : Activates area display

- ③ Move the arrow indicator to WIDTH to make desired width of cells to increase or decrease by using the Left / Right button between the level 0 ~ 100.
- ④ Move the arrow indicator to HEIGHT to make desired height of cells to increase or decrease by using the Left / Right button between the level 0 ~ 100.
- ⑤ Move the arrow indicator to the LEFT / RIGHT and TOP / BOTTOM to select the desired area position by using the LEFT or RIGHT button.
- ⑥ Move the arrow indicator to COLOR to select the desired color of each area cells by using the Left / Right button to select between the 15 different color.

RETURN : Move the arrow indicator to RETURN after completing the setup to return to SPECIAL menu.

4-3) SYNC : INT (Internal Synchronisation)

Move the arrow indicator to RETURN after complete the setup to return to SETUP menu.

5. DEFECT

You can eliminate white spots (defect) up to max 128 point.

SENSE-UP : To eliminate defect, set the high level of sense-up. You can set to max 64x, but 32x is best to eliminate defect.

DIFF : You can set the size of DEFECT from 1 to 6.

START : Press the "ENTER" button, it will start to eliminate defects "PROCESSING NOW..." will be displayed on the monitor.

In case of manual IRIS lens, you should cover the lens.

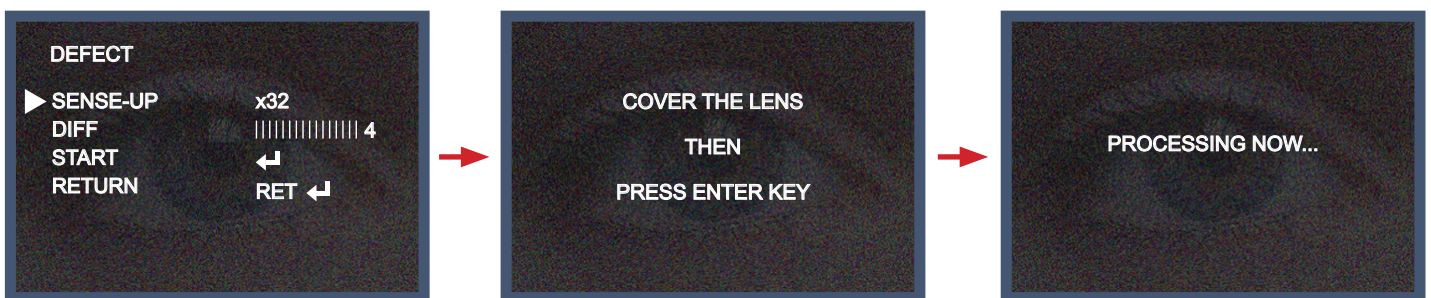

ADJUST

1. When the SETUP menu screen is displayed, select ADJUST using the Up and Down buttons.

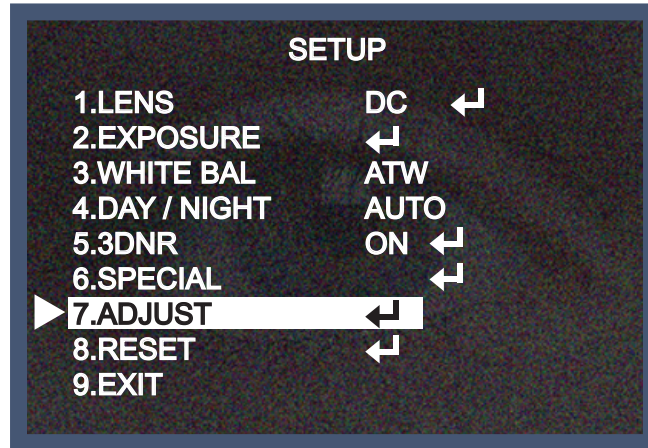

2. Select the desired mode by using Up or Down button.

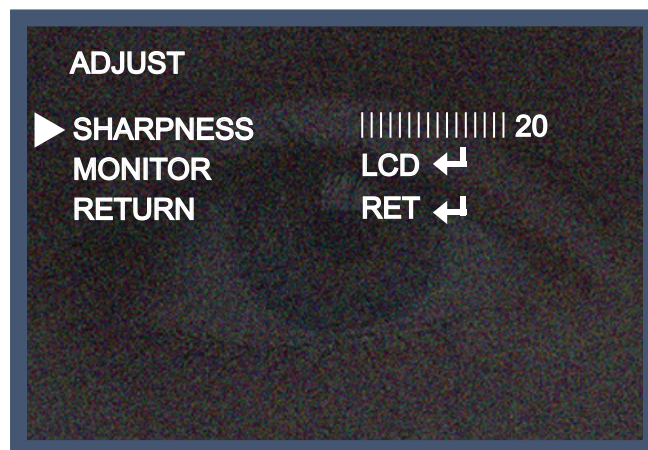

SHARPNESS : Improving image clarity. The level can be adjusted to obtain an improved image.

However, when the level is set too high it can distort the image or cause noise.

You can adjust from level 1 to 31, and can set to monitor function as LCD, CRT and USER.

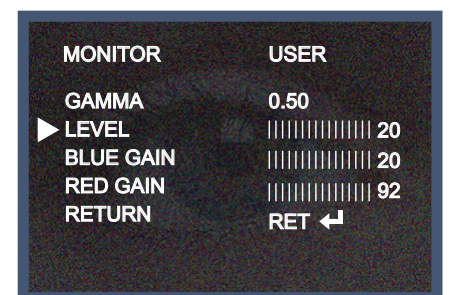
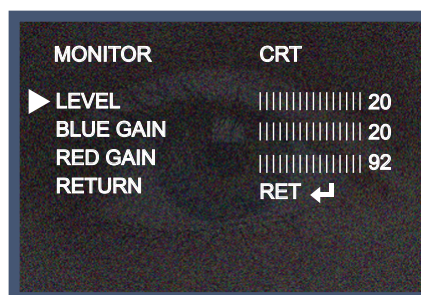
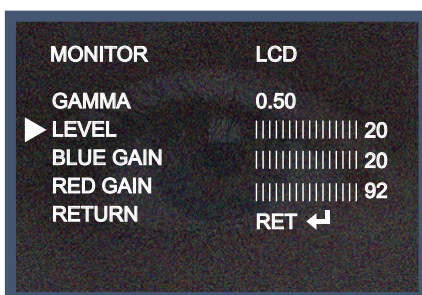

RESET

Resets the camera settings to the factory defaults.

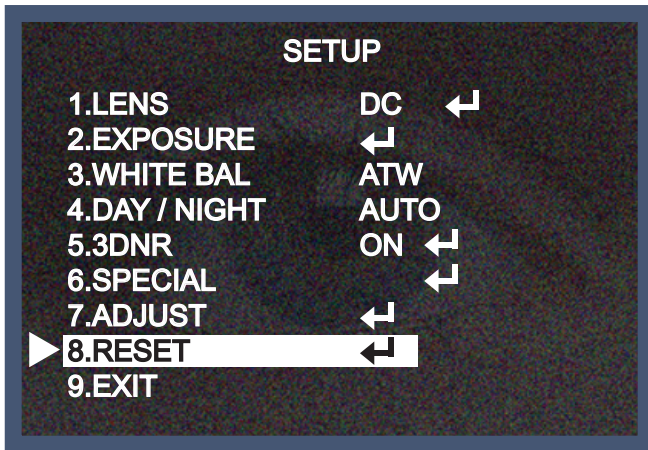

EXIT

Press the SET button in the EXIT menu to save the current settings and exit the SETUP menu.

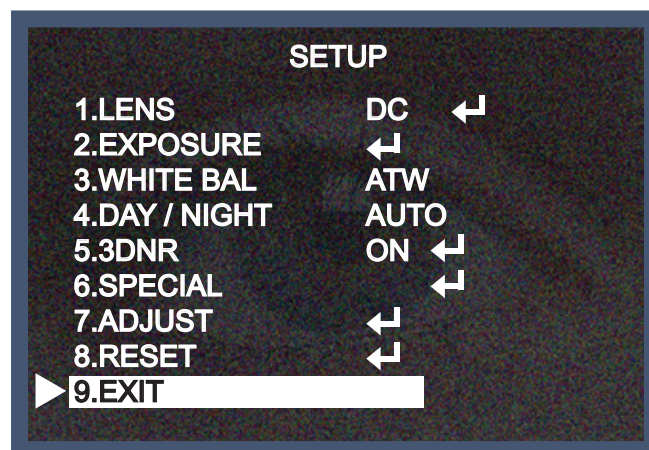

Trouble Shooting

PROBLEM	POSSIBLE CAUSE
Nothing appears on the screen.	<ul style="list-style-type: none"> ☞ Check the power cable, power supply output and video connection between the camera and monitor.
The image on the screen is dim.	<ul style="list-style-type: none"> ☞ Are the camera lens or the lens glass dirty? Clean the lens / glass with a soft clean cloth. ☞ Adjust the monitor controls, as required. ☞ If the camera is facing a very strong light, change the camera position. ☞ Adjust the lens focus.
The image on the screen is dark.	<ul style="list-style-type: none"> ☞ Adjust the contrast control of the monitor. ☞ If there is an intermediate device, correctly set the 75Ω/Hi-z.
The camera is not working properly and the surface of the camera is hot.	<ul style="list-style-type: none"> ☞ Check the camera is correctly connected to an appropriate regulated power source.
Motion Detection is not activated.	<ul style="list-style-type: none"> ☞ Has MOTION DET been set to ON in the menu? ☞ Has MD AREA been properly defined?
The color of the picture is not correct.	<ul style="list-style-type: none"> ☞ Check the settings in WHITE BALANCE menu.
The image on the screen flickers.	<ul style="list-style-type: none"> ☞ Make sure that the camera isn't facing direct sunlight or fluorescent lighting. If necessary, change the camera position.
The SENS-UP does not work.	<ul style="list-style-type: none"> ☞ Check that the AGC setting in the EXPOSURE menu is't set to OFF. ☞ Check the EXPOSURE menu and make sure SHUTTER is set to-----.



LIMITED WARRANTY - VIDEO PRODUCTS

THIS WARRANTY IS VALID ONLY ON PRODUCTS PURCHASED AND USED IN THE UNITED STATES OF AMERICA AND CANADA. THIS WARRANTY APPLIES ONLY TO THE ORIGINAL USER.

SUBJECT TO CONDITIONS AND EXCLUSIONS FOUND BELOW, THIS PRODUCT IS WARRANTED AGAINST MANUFACTURING DEFECTS IN MATERIAL AND WORKMANSHIP FOR THE FOLLOWING PERIOD FOR PARTS AND LABOR:

SPECO TECHNOLOGIES CAMERAS..... 5 YEARS	DVRs..... 3 YEARS
SPECO TECHNOLOGIES IP CAMERAS..... 2 YEARS	NVRs 3 YEARS
SPECO PTZ AND VL CAMERAS..... 1 YEAR	BALANCE OF
SPECO TECHNOLOGIES MONITORS..... 1 YEAR	SPECO TECHNOLOGIES LINE..... 1 YEAR
IR LEDS 90 DAYS	

SPECO TECHNOLOGIES WILL REPAIR OR REPLACE (AT OUR DISCRETION) ANY PARTS FOUND TO BE DEFECTIVE FOR THE WARRANTY PERIOD SPECIFIED. WE WILL PROVIDE A REPLACEMENT FOR ANY DEFECTIVE PART.

CONDITIONS

- 1. YOU MUST OBTAIN A RETURN AUTHORIZATION (RA) NUMBER FOR ANY MERCHANDISE BEING RETURNED TO SPECO TECHNOLOGIES, WHETHER FOR RETURN/EXCHANGE OR REPAIR, WHETHER IN OR OUT OF WARRANTY.**
- THIS WARRANTY WILL BE HONORED ONLY UPON PRESENTATION OF THE ORIGINAL DATED BILL OF SALE OR SALES SLIP.
- TRANSPORTATION OF THE PRODUCT TO OUR SERVICE DEPARTMENT IS THE RESPONSIBILITY OF THE USER. REPAIRED OR REPLACED PRODUCT WILL BE RETURNED PREPAID DURING THE WARRANTY PERIOD.
- SPECO TECHNOLOGIES DOES NOT AUTHORIZE ANY INTERNET OR MAIL ORDER PRODUCT SALES. IF A SPECO TECHNOLOGIES PRODUCT IS PURCHASED FROM AN UNAUTHORIZED DISTRIBUTOR OR OTHER SOURCE, INCLUDING RETAILERS, MAIL ORDER SELLERS AND ONLINE SELLERS, IT WILL NOT BE HONORED OR SERVICED UNDER THE EXISTING SPECO TECHNOLOGIES WARRANTY POLICY. ANY SPECO TECHNOLOGIES PRODUCT PURCHASED FROM THESE ONLINE MERCHANTS WILL VOID THE APPLICABLE WARRANTY AND IS INELIGIBLE FOR TECHNICAL SUPPORT. IF YOU HAVE QUESTIONS ABOUT A RESELLER, PLEASE CONTACT SPECO TECHNOLOGIES AT 1-800-645-5516 FOR A LIST OF UNAUTHORIZED DEALERS, VISIT: www.specotech.com/unauthorized.

EXCLUSIONS

- THIS WARRANTY SHALL NOT COVER ADJUSTMENT OF CUSTOMER OPERATED CONTROLS AS EXPLAINED IN THE APPROPRIATE Model 's INSTRUCTION MANUAL OR PRODUCTS WHICH HAVE BEEN ALTERED, ABUSED, OR HAVE MISSING OR ALTERED SERIAL NUMBERS.
- THIS WARRANTY SHALL NOT APPLY TO UNCRATING, SETUP, INSTALLATION, OR THE REMOVAL AND REINSTALLATION OF PRODUCTS AFTER REPAIR.
- THIS WARRANTY SHALL NOT APPLY TO REPAIRS OR REPLACEMENTS NECESSITATED BY ANY CAUSE BEYOND THE RESULT OF MANUFACTURE INCLUDING, BUT NOT LIMITED TO, ANY MALFUNCTION, DEFECTS OR FAILURE CAUSED BY OR RESULTING FROM UNAUTHORIZED SERVICE OR PARTS, IMPROPER MAINTENANCE, MODIFICATION OR REPAIR BY THE USER, ABUSE, MISUSE, NEGLIGENCE, ACCIDENT, FIRE, FLOOD, OR OTHER ACTS OF NATURE, INCORRECT LINE VOLTAGE, DAMAGE OR IMAGE BURNS TO TELEVISION PICTURE TUBES CAUSED BY OR ATTRIBUTABLE TO THE USE OF ANY ACCESSORY, ELECTRONICS GAME OR DEVICE, OR DAMAGE CAUSED TO IMAGE PICKUP DEVICES BY EXCESSIVE LIGHT.

THE FOREGOING IS IN LIEU OF ALL OTHER EXPRESSED WARRANTIES AND WE DO NOT AUTHORIZE ANY PARTY TO ASSUME FOR US ANY OTHER OBLIGATION OR LIABILITY. IN NO EVENT SHALL WE BE LIABLE FOR INCIDENTAL OR CONSEQUENTIAL DAMAGES ARISING FROM THE USE OF THIS PRODUCT, OR FOR ANY DELAY IN THE USE OF THIS PRODUCT DUE TO CAUSES BEYOND OUR CONTROL. SOME STATES DO NOT ALLOW LIMITATIONS OF HOW LONG AN IMPLIED WARRANTY LASTS AND/OR DO NOT ALLOW THE EXCLUSION OR LIMITATION OF CONSEQUENTIAL DAMAGES. THE ABOVE LIMITATIONS ON IMPLIED WARRANTY AND CONSEQUENTIAL DAMAGES MAY NOT APPLY TO YOU.

THIS WARRANTY GIVES YOU SPECIFIC LEGAL RIGHTS. YOU MAY HAVE OTHER RIGHTS WHICH VARY FROM STATE TO STATE.

NOTE: FOR YOUR PROTECTION IN THE EVENT OF THEFT OR LOSS OF THIS PRODUCT, PLEASE FILL IN THE INFORMATION REQUESTED BELOW AND RETAIN WITH YOUR SALES RECEIPT.

MODEL NO.: _____ SERIAL NO.: _____
(LOCATED ON BACK OR BOTTOM OF UNIT)

DATE OF PURCHASE: _____

WHERE PURCHASED: _____ PURCHASE PRICE: _____

Speco Technologies 200 New Highway Amityville, NY 11701 www.specotech.com	FOR MORE INFORMATION REGARDING SERVICE OR RETURN, CALL US TOLL FREE: 1-800-645-5516 IN METRO NY: 631-957-8700
---	---

ALWAYS USE DISCRETION WHEN INSTALLING VIDEO AND/OR AUDIO SURVEILLANCE EQUIPMENT ESPECIALLY WHEN THERE IS AN EXPECTATION OF PRIVACY. INQUIRE REGARDING FEDERAL, STATE AND/OR LOCAL REGULATIONS APPLICABLE TO THE LAWFUL INSTALLATION OF VIDEO AND/OR AUDIO RECORDING OR SURVEILLANCE EQUIPMENT. PARTY CONSENT MAY BE REQUIRED.

- MEMO -

- MEMO -

- MEMO -

- MEMO -



**200 New Highway
Amityville, NY 11701
631-957-8700
1 800 645 5516
www.specotech.com**