

CAMDEN MOUNTING BOXES

FEATURES

- THE INDUSTRY'S LARGEST ASSORTMENT OF MOUNTING BOXES, ESCUTCHEONS, TRIM PLATES AND SLEEVES.
- SOLUTIONS FOR SURFACE AND FLUSH MOUNTING, INDOOR, OUTDOOR AND WATER TIGHT APPLICATIONS.
- FLAME AND IMPACT RESISTANT POLYMER (ABS) MODELS.
- HEAVY GAUGE STAINLESS AND ALUMINUM MODELS

NARROW/JAMB MOUNTING BOXES

MODEL: CM-23

Size: Narrow/Jamb width
Type: Surface mount box
Construction: Flame and impact resistant black polymer (ABS)
Application: Indoor/outdoor, wired
For Switch Series: CM-25, CM-250, CM-310
Cover Plate: CM-23CP

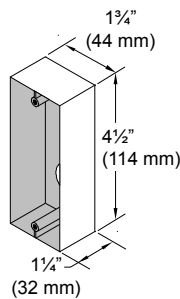

MODEL: CM-23D

Size: Narrow/Jamb width, extra depth
Type: Surface mount box
Construction: Flame and impact resistant black polymer (ABS)
Application: Indoor/outdoor, wired. Required for wireless.
For Switch Series: CM-25, CM-170, CM-250, CM-310, CM-325/N, CM-2200

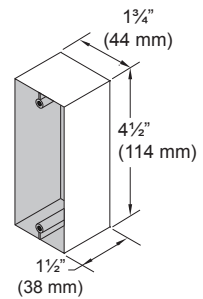

SINGLE GANG MOUNTING BOXES

MODEL: CM-34BL

Size: Single gang, std. depth
Type: Surface mount box
Construction: Double wall, black (ABS)
Application: Indoor, wired or wireless
For Switch Series: CM-35, CM-180, CM-190/3/4, CM-280, CM-300, CM-325, CM-400, CM-700, CM-1200
Gasket: CM-120G
Cover Plate: CM-34CP

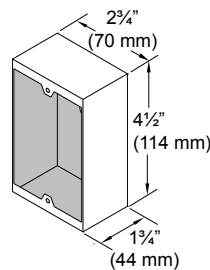

MODEL: CM-34AL

Size: Single gang, std. depth
Type: Surface mount box, threaded conduit entry
Construction: Heavy duty cast aluminum
Application: Water tight, wired
For Switch Series: CM-35, CM-180, CM-190/3/4, CM-280, CM-300, CM-325, CM-400, CM-4000, CM-5000, CM-700, CM-1100, CM-1200, supplied with CM-1000 Series
Gasket: CM-120G

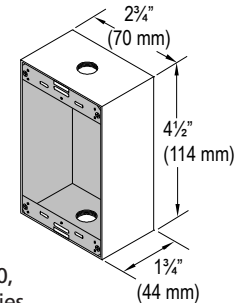

MODEL: CM-34D

Size: Single gang, extra depth
Type: Surface mount box
Construction: Heavy duty grey polymer
Application: Indoor/outdoor, wired. Required for wireless
For Switch Series: CM-30, CM-3000, CM-4085/5085/7085/8085
Gasket: CM-120G

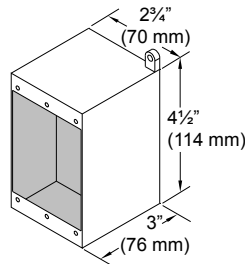

MODEL: CM-31

Size: Single gang
Type: Sleeve for standard 2" x 4" surface electrical box
Construction: Heavy gauge stainless steel
Application: Adds brushed SS finish to standard electrical box
For Switch Series: CM-35, CM-180, CM-190/3/4, CM-280, CM-300, CM-325, CM-1200

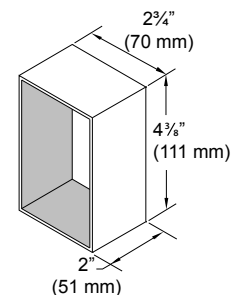

CAMDEN MOUNTING BOXES

MODEL: CM-66

Size: Single gang, std depth

Type: 7" x 7" dress plate and standard 2" x 4" flush electrical box

Construction: Heavy gauge stainless steel

Application: Extra wide trim plate c/w box to cover double gang sized openings

For Switch Series:

CM-35, CM-40, CM-41, CM-45, CM-60

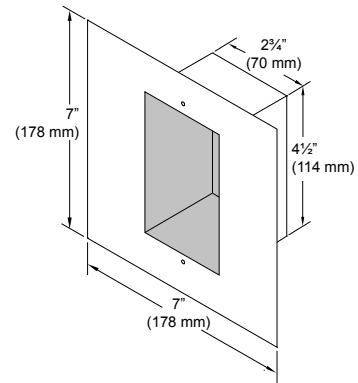

DOUBLE GANG/SQUARE MOUNTING BOXES

MODEL: CM-43CBL

Size: 5" Square, std. depth

Type: Surface mount box

Construction: Double wall, black (ABS)

Application: Indoor/outdoor, wired. Required for wireless.

Cover Plate: CM-43CP

For Switch Series:

CM-41, CM-45, CM-46

CM-43CBLA: Surface Box for CM-325W switches

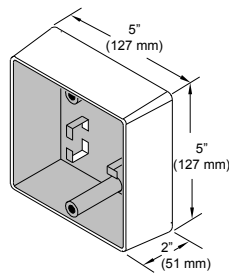

MODEL: CM-53

Size: Double gang, std. depth

Type: Surface mount box

Construction: Double wall, black (ABS)

Application: Indoor/outdoor, for double gang switches and vestibule switches.

For Switch Series:

CM-500, CM-2510, C, CM-3200, CM-3500

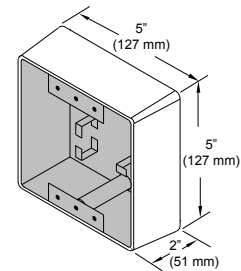

MODELS: CM-54B (BLUE ONLY), CM-54BR (BLUE/RED), CM-54GR (GREEN/RED)

Size: 5 1/4" Square, std. depth

Type: Illuminated surface mount box

Construction: Double wall, black (ABS)

Application: Illuminated push plate switch enclosure, (room for wireless transmitter.)

For Switch Series:

CM-45, CM-46, SPDT only

Note: Insert is clear polycarbonate

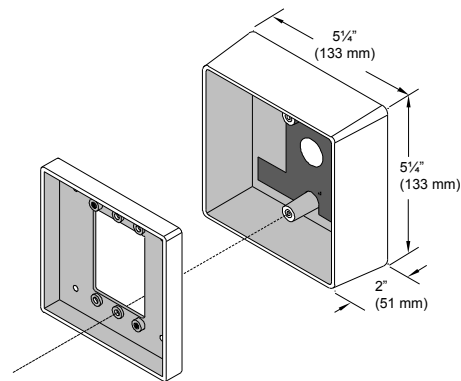

MODEL: CM-63CBL

Size: 5" Square, std. depth

Type: Surface mount box,

Construction: Double wall, black (ABS)

Application: Indoor/outdoor, wired. Required for wireless.

For Switch Series: CM-60

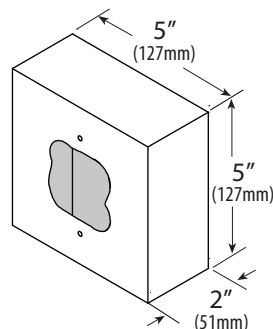

MODEL: CM-48AL

Size: Double gang, shallow

Type: Surface mount box

Construction: Anodized aluminum

Application: Indoor/outdoor, wired.

For Switch Series:

CM-45, CM-46, CM-41 (Requires CM-49C adaptor plate, sold separately)

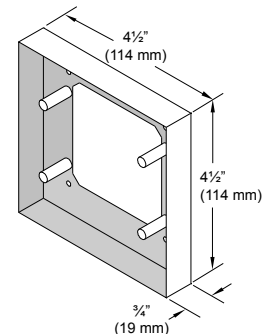

CAMDEN MOUNTING BOXES

MODEL: CM-44

Size: Double gang, shallow

Type: Offset surface mount box

Construction: Stainless steel

Application: For mounting 4 1/2" square switches on narrow jambs, indoor/outdoor, wired.

For Switch Series:

CM-41, CM-45, CM-46

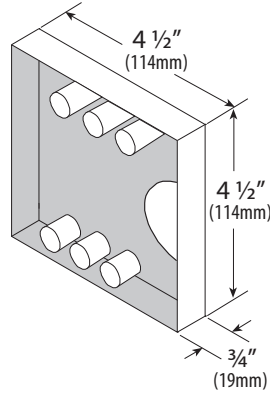

MODEL: CM-540B

Size: Double gang, shallow

Type: Semi flush mount box

Construction: Flame and impact resistant black polymer (ABS)

Application: Indoor/outdoor, wired

For Switch Series:

CM-41, CM-45, CM-46

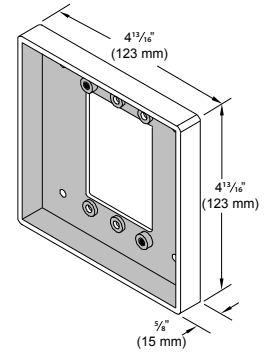

MODEL: CM-67

Size: Double gang

Type: Sleeve for standard 4" x 4" surface electrical box

Construction: Heavy gauge stainless steel

Application: Adds brushed SS finish to standard electrical box

For Switch Series:

CM-41, CM-45, CM-46, CM-60

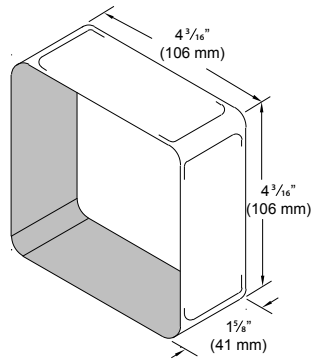

MODEL: CM-68AL

(Anodized Aluminum finish)
CM-68BZ (Anodized dark bronze finish)

Size: Double gang, shallow

Type: Surface mount box

Construction: Anodized aluminum

Application: Indoor/outdoor, wired

For Switch Series:

CM-60 (Requires CM-49C adaptor plate, sold with switch)

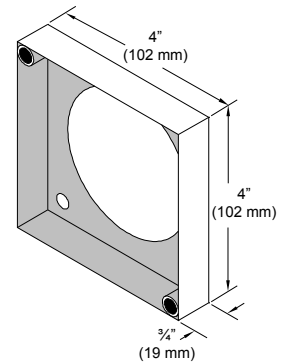

MODEL: CM-440

Size: Double gang

Type: 5" flush dress plate

Construction: Stainless steel

Application: For mounting 4 1/2" round switch on standard single and double gang electrical box

For Switch Series: CM-40

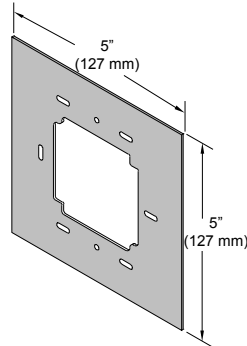

MODEL: CM-660

Size: Double gang

Type: 6 1/2" flush dress plate

Construction: Stainless steel

Application: For mounting 6" switches on standard single, double gang and 4" square electrical boxes

For Switch Series:

CM-45, CM-46, CM-60

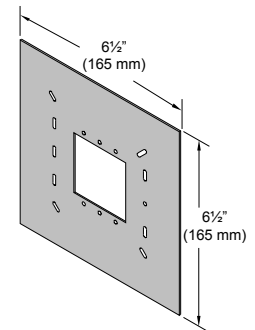

MODEL: CM-49C

Size: Double gang

Type: Adapter plate

Construction: Galvanized steel

Application: For mounting CM-41, CM-45, CM-60 switches on double gang and 4" square mounting boxes

For Switch Series:

CM-45, CM-46 (included with CM-60)

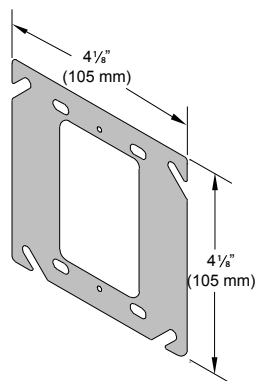

4 1/2" ROUND SWITCH MOUNTING ENCLOSURES

MODEL: CM-47S

Size: 5" round, std. depth
Type: Surface mount box
Construction: Flame and Impact resistant black polymer (ABS)
Application: Indoor/outdoor, wired. Required for wireless
For Switch Series: CM-40

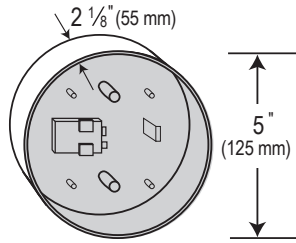

MODEL: CM-59S

Size: 7 3/4" round, std. depth
Type: Surface mount escutcheon
Construction: Heavy gauge stainless steel
Application: Vandal resistant indoor/outdoor, wired.
For Switch Series: CM-40

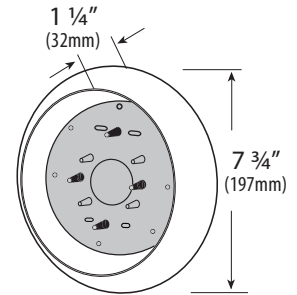

MODEL: CM-49

Size: 8 3/4" round, 1 13/16" depth
Type: 2 pcs. surface or semi flush mount escutcheon, gasket and adapter plate included
Construction: Flame and impact resistant black polymer (ABS)
Application: Vandal resistant indoor/outdoor
CM-49A: Semi flush mounting on single gang electrical box, wired
CM-49B: Surface mount. Wired, required for wireless. Must be used with CM-49A
CM-49C: Adapter plate to mount CM-49A on double gang and 4" square electrical box
CM-49G: Gasket for CM-49A or CM-49B
For Switch Series: CM-40

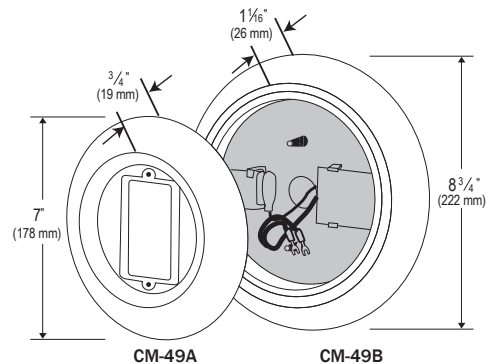

6" ROUND SWITCH MOUNTING ENCLOSURES

MODEL: CM-69S

Size: 6 1/2" round, std. depth
Type: Surface mount box
Construction: Flame and Impact resistant black polymer (ABS)
Application: Indoor/outdoor, wired. Required for wireless
For Switch Series: CM-60

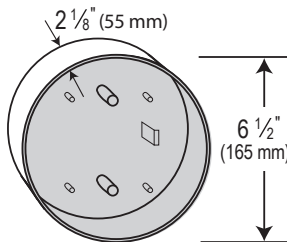

MODEL: CM-89S

Size: 9 5/8" round, std. depth
Type: Surface mount escutcheon
Construction: Heavy gauge stainless steel
Application: Vandal resistant indoor/outdoor, wired.
For Switch Series: CM-60

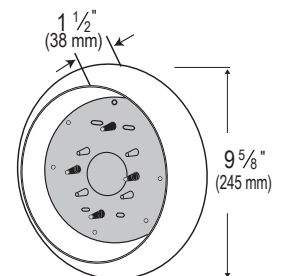

MODEL: CM-79

Size: 9 5/8" round, 1 13/16" depth
Type: 2 pcs. surface and semi flush mount escutcheon, gasket and adapter plate included
Construction: Flame and impact resistant black polymer (ABS)
Application: Vandal resistant indoor/outdoor
CM-79A: Semi flush mounting on single gang electrical box, wired
CM-79B: Surface mount. Wired, required for wireless. Must be used with CM-79A
CM-79C: Adapter plate to mount CM-79A on double gang and 4" square electrical box
CM-79G: Gasket for CM-79A or CM-79B
For Switch Series: CM-60

