

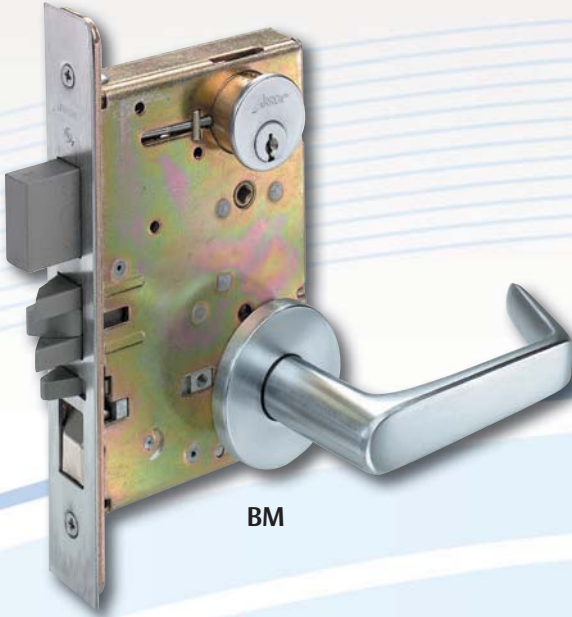

DC516



DC325



BM



QL



MLX



ED910

All products
shown are



Arrow 2018 Price Book Effective November 1, 2018

ASSA ABLOY, the global leader
in door opening solutions



ASSA ABLOY



ASSA ABLOY



ARROW USA

Dock 2
225 Episcopal Road
Berlin, CT 06307
Phone: (800) 839-3157
Fax: (800) 421-6615
info@arrowlock.com

ORDERS & CUSTOMER SERVICE:

Arrow Lock & Door Hardware

P.O. Box 3075
Salem, VA 24153
Phone USA: 800-839-3157
Fax: 800-421-6615

INVOICE PAYMENTS ONLY

Arrow Lock Accounts Receivable

P.O. Box 640711
Pittsburgh, PA 15264

RETURN GOODS ONLY (RGA# REQUIRED)

Arrow Lock & Door Hardware

Dock 2
225 Episcopal Road
Berlin, CT 06307



Arrow Canada

160 Four Valley Drive
Vaughn, ON L4K 4T9
Canada

Phone: 1.800.461.3007

Fax: 1.800.461.8989

Note: The prices contained in this price book will vary from those in our Canadian price book.

Table of Contents

Terms & Condition of Sale	2
Limited Warranty	6
General Procedure/Finishes	7
Mortise Locks	
AM Series	8
BM Series	13
Cylindrical & Tubular Locks	
QL Series	25
GL Series	27
HK Series	29
MK Series	31
MLX Series	35
RK Series	37
RL Series	38
CL Series	40
RLX	44
Auxiliary Locks	
DBX	46
D Series	48
E Series	49
N Series	52
Padlocks	54
Keys & Cylinders	
Keys & Keying Charges	55
Mortise & Rim Cylinder	56
KIK, Lever & Deadbolt Cylinders	57
IC Housings	58
Arrow Pointe SFIC Cylinders	59
Pointe Flex SFIC Cylinders	61
Sliding Door Lock	61
Cam Lock	62
Plus Housings	63
Cylinder Parts & Tools	64

Panic Devices	
30 Series	65
40 Series (narrow stile)	69
Electrified Options	72
S1150/S1250	73
ED910/PEC910 Series	73
Mullions	76
Closers and Operators	
7700 Series	79
7800/7900 Series	80
DC300 Series	82
DC500 Series	83
5016N Series	84
Alarmed Hardware	85

DISCONTINUED PRODUCTS	
Keyless Entry	
V1 Series	90
V2 Series	92
V3 Series	93
Cylindrical & Tubular Locks	
Q Series	94
H Series	100
ML Series	104
CK Series	109
Auxiliary Locks	
DB Series	113
Closers and Operators	
900N Series	115



Terms & Conditions of Sale

Acceptance

ARROW LOCK reserves the right to decline an order, in whole or in part, when the type or quantity of goods or credit worthiness of the Purchaser is not satisfactory to us in our sole and absolute discretion.

Purchase Orders, Quote requests, Acknowledgements or the like issued by the Purchaser that have contrary standard terms and conditions are not binding on ARROW LOCK, unless such terms and conditions are approved in a separate written agreement by ARROW LOCK's authorized representatives. In the event of an acceptance of Purchaser's Purchase Order by ARROW LOCK, the Purchaser agrees that such acceptance is solely conditioned on Purchaser's acceptance of the terms and conditions set forth in this instrument, regardless of the terms and conditions specified in the Purchaser's Purchase order. The terms and conditions in Purchaser's Purchase order which conflict with terms and conditions of this instrument shall be disregarded and are hereby rejected, and this instrument shall constitute the entire agreement between ARROW LOCK and the Purchaser.

In the event that ARROW LOCK does not enforce or require strict performance of any term or condition hereof, or of any other document, instrument or other agreement relating to goods sold, such lack of enforcement or requirement of strict performance will not waive, affect or diminish any right of ARROW LOCK to enforce or require strict performance of such term or condition in the future.

Prices

All prices are subject to change without notice and are not guaranteed. All shipments will be made at prices in effect at the time of order acceptance.

Possession of this price list does not constitute an agreement to sell. We reserve the right to correct clerical, stenographic and other obvious errors at any time.

Terms

2% 10 net 30 days after invoice date.

It is understood that ARROW LOCK may impose and charge a finance charge which is the lesser or one and one-half percent (1-1/2%) per month or the highest rate allowed by law on any amount which becomes past due and delinquent. Additionally the customer shall be responsible for all collection costs, court costs and reasonable attorney's fees (where allowed by law) in connection with the recovery of any delinquent amount.

Freight

All orders are shipped FOB factory/warehouse, except as expressly provided below. When delivered to the Transportation Company, the Purchaser assumes the risk of loss or damage in transit.

Customer orders with net product value in excess of \$5,000.00 will be shipped prepaid by ARROW LOCK's carrier of choice and routing to a single destination point in the United States.

Customer orders with net product value less than \$5,000.00 will be shipped prepaid by ARROW LOCK's carrier of choice and routing and shipping and handling charges will be added to customer's invoice.

If the customer requests an expedited method of shipment such as "Next Day Air" the charges will be prepaid by ARROW LOCK and the full rate for the service, as published by the carrier, will be added to the customer's invoice.

Great Grand Master keys, Grand Master keys, Master keys, Construction Master keys, Control Keys, which are shipped separate from customer order for security reasons, on orders with net product value in excess of \$5,000 will be shipped prepaid by ARROW LOCK's carrier of choice. If the total order value is less than \$5,000.00, the shipping charges will be added to customer's invoice.

ARROW LOCK will pack, mark and ship the products according to its standard procedures for shipment, unless the parties agree, in writing, that ARROW LOCK will comply with any special instructions provided by the customer. Special instructions must be submitted, in writing, at time of order placement. Compliance with special instructions may result in an increased price.

Terms & Conditions of Sale

Minimum Invoice

Minimum invoice for complete product is \$200.00 net product value. The minimum invoice for parts orders is \$100.00 net product value. In the event that the net product value does not meet the required net minimum, ARROW LOCK may, at its sole discretion (a) apply a minimum order charge, (b) reject the order or (c) waive the minimum requirement provided that the waiver of the requirement for one order shall not constitute a waiver of the requirement for any future orders.

This policy does not include the following: Cut (bitted) Keys of any type, Master Keyed Cylinders, Master Keyed Padlocks and factory-generated bitting Lists.

Same day order expedites will be invoiced at book net.

Quotations

If ARROW LOCK elects to offer a quote; such quote will be valid until the expiration date on that quote. Complete shipment of the order must be accepted by Purchaser within standard lead times.

The quote number must be referenced on the order. Any invoiced order that has the incorrect discount applied to it and did not have the quote number written on the order will have a service fee of \$100.00 net DEDUCTED from any sales credit issued for the difference in discount.

The quote is null and void if the Purchase Order does not include ALL product lines listed on the quote or if the quantities for an item covered by the quote deviate by 10% or more.

With the issuance and acceptance of a quote for the purchase of products, the Purchaser agrees that products so purchased will not be resold or transferred to any Distributor not authorized by ARROW LOCK to sell its products. This would be inclusive of branches of the quoted Distributor. Failure to abide by this restriction may result in the Distributor's ineligibility for Price Concession Authorizations, or other actions in ARROW LOCK's discretion.

ARROW LOCK and its sales representatives reserve the right, in their sole discretion and for any reason, to refuse a Distributor's request to quote a price other than ARROW LOCK's standard list price and regardless of whether ARROW LOCK or its sales representatives have previously quoted discounted prices to the Distributor on some or all of its orders.

Non-Cataloged Products

Products not cataloged or listed in this price book will be considered as special products, and will not be manufactured without prior approval from ARROW LOCK. All non-cataloged goods cannot be changed or cancelled.

A minimum special handling charge of \$50.00 will be added for non-cataloged product. Any additional labor or material required will be charged accordingly. Any additional labor or material required will be charged accordingly.

Special products require special handling, and therefore standard lead times may not apply. Please consult with your Sales Representative for further details.

Change or Cancellation of Orders

Changes or cancellations to an order will result in a charge of costs for material and labor expenses that have been incurred prior to notification from customer. Handling charges are billed on customer's original order. If products have already been made and/or are located in the shipping room, a 45% restocking fee will apply.

Arrow Express Orders may not be changed or cancelled.

Except for the reasons stated above, all change requests must be submitted in writing to customer Service within two (2) business days of receipt of acknowledgement of the order.

Add-On Orders to Quote

Any new order requesting special pricing to match an existing quote number, which has already been ordered, will be accepted up to sixty (60) days after the acknowledgement of the original order. All add-on orders must reference the original factory order number and the corresponding quote number to receive the quoted pricing discount. Add-on orders for stock will not be accepted.



Terms & Conditions of Sale

Delivery

Orders will be acknowledged and given a scheduled delivery date based on estimated manufacturing lead times. Complete information is required to process all orders. Orders with insufficient information for processing (i.e. keying information, door sizes, etc.) may be subject to extended lead times which are relative to the time required in obtaining the necessary information for order processing. Manufacturing lead time will begin once all information is received to process an order. ARROW LOCK will use reasonable efforts to deliver products as estimated, but makes no guarantees as to delivery dates.

ARROW LOCK will not be liable for back charges incurred based on availability of product or as a result of delays in delivery caused by insufficient information required to process an order.

ARROW LOCK will not be held responsible for delays in delivery caused by strikes, fires, floods or any other causes beyond our control, including the delivery of material to us. Under no circumstances shall ARROW LOCK be liable or accountable for consequential damages due to failure of delivery.

Claims

In the event of Company or customer error, claims for shortages, pricing errors and/or incorrectly filled orders must be submitted in writing to Customer Service within thirty (30) days from receipt of material.

Any claims for shortages or damage by the Carrier must be made by the customer directly to the Carrier.

Invoice Deduction

An ARROW LOCK Sales Representative or Customer Service Representative must be notified of any disputed invoices within sixty (60) days from the date of invoice. Deductions should only be taken for the disputed amount and the balance of the invoice is due and payable within standard payment terms.

Returned Goods

It is the policy of ARROW LOCK to not accept returns of any materials that are correctly furnished as per the Distributor's Purchase Order. Return of product due to customer order error or accommodation must be pre-arranged with ARROW LOCK and approved in writing by Sales Management.

All products returned as "Goodwill" must meet the following criteria to be considered a return:

- Be in original, unmarked, and undamaged cartons
- Be valued in excess of \$200.00 net
- Shipped and invoiced within the previous one-hundred twenty (120) days
- Custom, non-cataloged goods, master-keyed or ARROW LOCK Arrow Express shipped products are not returnable

A MINIMUM restocking fee of 45% will be charged. Upon receipt and verification by ARROW LOCK that the returned merchandise meets the foregoing conditions, a credit will be issued for the original invoice amount less the MINIMUM 45% restocking fee. Defective goods and "Goodwill" products that meet the foregoing criteria may be returned by fulfilling the following conditions:

- Send an RGA request in writing to the ARROW LOCK Sales Representative serving the Purchaser's area
- Ensure the RGA labels that are sent to Purchaser by ARROW LOCK are visible on return goods shipment
- Ensure that the RGA number appears on the return shipment label and is legible
- Return the authorized merchandise within sixty (60) days from the date of RGA issuance date
- Return shipments must be freight prepaid to the location specified on the RGA. ARROW LOCK is not liable for damages to product during shipping.

No credit may be taken or issued prior to RGA approval and receipt of product. All defective goods within the terms of our limited warranty may be returned for credit or replacement.

Terms & Conditions of Sale

Taxes

Prices do not include any present or future Federal, State, or Local property, license, privilege, sales, use, and excise, gross receipts or other like taxes or assessments, which may result from transactions or any services performed in connection herewith.

Governing Law

The rights and obligations of the parties shall be governed by the laws of the State of New York, excluding any conflicts of law provisions. The United Nations Convention on Contracts for the International Sale of Goods shall not apply to this Agreement.

Limited Warranty

The Terms and Conditions outlined above are subject to ARROW LOCK Limited Warranty, which is included in this Price List and incorporated herein by reference.

Product Modifications

ARROW LOCK products are not designed for or intended for aftermarket modification. The warranty on ARROW LOCK products becomes void if the product is modified in any way, regardless of whether the modification causes or contributes to any alleged defect. Warranty voiding modifications include, but are not limited to, third-party electrification of non-electric products and/or the installation of non-approved or non-ARROW LOCK components.

If an ARROW LOCK product is modified it no longer meets industry certification and quality control standards applicable to the original product and is no longer a genuine ARROW LOCK product. A modified product may not be sold as an ARROW LOCK product and no ARROW LOCK trademarks or certification marks based on the original ARROW LOCK product, such as U.L. or ANSI/BHMA marks, may appear anywhere on the modified product or on any packaging, literature or instructions sold with the modified product.

All original ARROW LOCK packaging and literature carrying ARROW LOCK trademarks and must be destroyed if the original ARROW LOCK product is modified. Portions of the product that carry an ARROW LOCK trademark or certification mark, such as mortise faceplates, lock bodies, etc. must be discarded and/or replaced by the party making the modification. U.L. and other certification testing and marking are also the responsibility of the party making modification. The use of ARROW LOCK trademarks on modified products constitutes trademark infringement.

Individual Components

Component parts including but not limited to latches sold separate from locksets are intended to be sold as replacement components for appropriate ARROW LOCK products only. All other uses require prior written approval from ARROW LOCK.

Fire-Rated Openings

Any retrofit or other field modification to a fire-rated opening can potentially impact the fire rating of the opening, and ARROW LOCK makes no representations or warranties concerning what such impact may be in any specific situation. When retrofitting any portion of an existing fire-rated opening, or specifying and installing a new fire-rated opening, please consult with a code specialist or local code official (Authority Having Jurisdiction) to ensure compliance with all applicable codes and ratings.

Technical Information and Advice

(a) All designs, data, and specifications provided by ARROW LOCK are proprietary and will not be disclosed or reused by customer without the prior written consent of ARROW LOCK; (b) ARROW LOCK assumes no obligation or liability for any advice given by ARROW LOCK, the results obtained, or damages incurred, and all such advice is given and accepted at customer's risk.

Trademark Use

ARROW LOCK is a registered trademark of ARROW LOCK Manufacturing Company.

Other product brand names may be trademarks or registered trademarks of their respective owners and are mentioned for reference purposes only.



Limited Warranty

Limited Warranty

ARROW LOCK warrants that its products sold under the ARROW LOCK trade name in the United States of America are free from defects in workmanship and materials under normal use and service.

This warranty does not cover defects or damage arising from improper installation, lack of or improper maintenance, improper storage, shipping and handling, corrosion, erosion, ordinary wear and tear, misuse, abuse, accident, unauthorized service, or use with unauthorized non-ARROW LOCK products or parts. This warranty is void if any modification is made to the warranty product, regardless of whether the modification causes or contributes to the alleged defect. All modifications are made at the risk of the party making the modification.

The only liability of ARROW LOCK in tort or contract whether under this warranty or otherwise shall be limited to the repair or replacement of any product or component part which shall prove defective as covered by this warranty. The warranty period after delivery to the original purchaser in all cases is as follows:

Locks

AM & BM Series.....	5 Years
CL Series	5 Years
GL Series.....	5 Years
HK Series.....	10 Years
MLX Series.....	10 Years
QL Series	10 Years
RK & RL Series.....	5 Years
RLX Series	10 Years

Door Controls

5016N Series	10 Years
7700 Series	1 Year
7800 & 7900 Series.....	2 Years
DC300 Series.....	10 Years
DC500 Series.....	10 Years

Exit Devices

3000 & 4000 Series.....	5 Years
ED910 & PEC910 Series	10 Years
S1150 & S1250 Series	3 Years

Other

All other ARROW LOCK products.....1 year

Warranty Requirements for Cylinders Factory or Field Combined

Cylinders shall be periodically lubricated depending on environmental conditions. Petroleum based lubricant is recommended. Petroleum based liquid lubricants should only be used in cylinders in harsh or corrosive environments and should never be mixed with dry lubricants.

Warranty for cylinders Field Combined

1. Keys shall be cut to the ARROW LOCK key biting specifications required for the particular keyway and depth system.
2. All pin lengths shall be selected according to prevailing factory standards.
3. Original ARROW LOCK cylinder components, including pin tumblers and key blanks, shall be used. We reserve the right to void the warranty if we deem that a malfunction is a result of non-original components which do not conform to ARROW LOCK® standards.

Keying Systems

All bittings shall be originated or authorized by the ARROW LOCK Key Systems Department to be compatible with one another in a specific type of cylinder (conventional, security, high security, interchangeable core, removable core) and within a particular keying system.

General Procedure/Finishes

General Procedure

ARROW LOCK will not pay for the cost of repair, replacement, or associated charges under this warranty unless prior written authorization has been given by ARROW LOCK.

Refer to our Returned Goods Policy regarding the return of a product or component part believed to be defective as covered by this warranty. A brief description of the defect will be required. Product will be examined upon return. In the event such examination reveals a defect covered by this warranty, the product will be repaired or replaced.

THIS WARRANTY IS IN LIEU OF ALL OTHER EXPRESS WARRANTIES. TO THE EXTENT PERMITTED BY LAW, ALL IMPLIED WARRANTIES ARE LIMITED TO THE DURATION OF THIS WARRANTY. ARROW LOCK MANUFACTURING COMPANY SHALL NOT BE LIABLE FOR ANY INCIDENTAL OR CONSEQUENTIAL DAMAGES. NO AGENT, SALES REPRESENTATIVE OR DEALER HAS THE AUTHORITY TO INCREASE OR ALTER THE OBLIGATIONS OF THIS WARRANTY.

SOME STATES DO NOT ALLOW LIMITATIONS ON HOW LONG AN IMPLIED WARRANTY LASTS OR THE EXCLUSION OR LIMITATION OF INCIDENTAL OR CONSEQUENTIAL DAMAGES, SO THE ABOVE LIMITATIONS OR EXCLUSIONS MAY NOT APPLY TO YOU.

THIS WARRANTY GIVES YOU SPECIFIC LEGAL RIGHTS, AND YOU MAY ALSO HAVE OTHER RIGHTS WHICH VARY FROM STATE TO STATE.

Finishes

Description	Arrow Code	BHMA Code	U.S. Code
Bright brass	03	605	US3
Satin brass	04	606	US4
Antique brass	05A	609	US5
Satin bronze	10	612	US10
Dark oxidized satin bronze, oil rubbed	10B	613	US10B
Dark oxidized satin bronze, equivalent	10BE	613E	US10BE
Dark oxidized satin bronze, clear coated	10BP	614	US10BL
Satin nickel	15	619	US15
Bright chromium plated	26	625	US26
Satin chromium plated	26D	626	US26D
Bright stainless steel	32	629	US32
Satin stainless steel	32D	630	US32D

Description	Arrow Code	BHMA Code	
Aluminum painted or powder coated	AL	689	-
Black painted or powder coated	BLK	693	-
Dark bronze painted or powder coated	BRZ/DBZ	690	-
Satin brass painted or powder coated	GL	696	-
Light bronze painted or powder coated	LBZ	691	-
Red painted or powder coated	RD	-	-
Black suede powder coated	BSP	-	-

- Not all finishes are available for all product lines. Consult product sections for applicable finishes.

AM Series

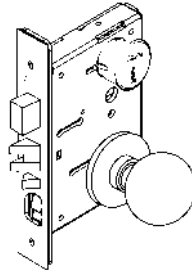

Features

Certification	BHMA A156.13, Series 1000, Operations Grade 1, UL Listed
Door Thickness	1-3/4"
Strike	Standard: ANSI 1-1/4" x 4-7/8", straight lip, with box; curved lip available
Latch	3/4" throw, stainless steel
Bolt	1" throw, stainless steel
Backset	2-3/4"
Cylinder	Standard: 6-pin, solid brass, 2 nickel-silver keys; IC prep available
Handing	Handed, field reversible without disassembling lock case
Case Quantity	10
Average Case Weight	58 lbs.
Warranty	5 years

Available Finishes	Arrow Code	BHMA Code	U.S. Code
Bright brass	03	605	US3
Satin brass	04	606	US4
Satin bronze	10	612	US10
Dark oxidized satin bronze, oil rubbed	10B	613	US10B
Dark oxidized satin bronze, equivalent	10BE	613E	US10BE
Bright chromium plated	26	625	US26
Satin chromium plated	26D	626	US26D
Satin stainless steel	32D	630	US32D

How to Order

Function	AM11
Trim	AM11-HTHA
Finish	AM11-HTHA-26D
Strike	AM11-HTHA-26D-460
Handing	AM11-HTHA-26D-460-RH
Keying	AM11-HTHA-26D-460-RH-KD-AR

AM Series Knob Designs

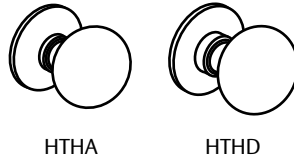

Non-Keyed Functions

Function	ANSI	Description	26D	03, 04, 10, 10B, 10BE, 26	32D
AM01	F01	Passage	\$544.00	\$584.00	\$600.00
AM02	F19	Privacy	\$616.00	\$656.00	\$672.00
AM07	-	Exit	\$616.00	\$636.00	\$644.00
AM26	F22	Privacy	\$616.00	\$656.00	\$672.00
AM08	-	Single Dummy	\$256.00	\$276.00	\$284.00
AM09	-	Full Dummy	\$477.00	\$517.00	\$533.00

Single Cylinder Functions

Function	ANSI	Description	26D	03, 04, 10, 10B, 10BE, 26	32D
AM11	F12	Apartment	\$716.00	\$756.00	\$772.00
AM12	F07	Storeroom	\$709.00	\$749.00	\$765.00
AM13	F21	Front Door	\$716.00	\$756.00	\$772.00
AM17	F05	Classroom	\$709.00	\$749.00	\$765.00
AM19	F13	Dormitory	\$716.00	\$756.00	\$772.00
AM20	F20	Entrance	\$716.00	\$756.00	\$772.00
AM21	F08/F10	Entrance	\$716.00	\$756.00	\$772.00
AM22	F04	Office	\$709.00	\$749.00	\$765.00
AM23	-	Vestibule	\$709.00	\$749.00	\$765.00
AM24	-	Storeroom	\$709.00	\$749.00	\$765.00
AM27	-	Institutional Privacy	\$709.00	\$749.00	\$765.00

Double Cylinder Functions

Function	ANSI	Description	26D	03, 04, 10, 10B, 10BE, 26	32D
AM31	F14	Storeroom	\$743.00	\$783.00	\$799.00
AM32	F09	Vestibule	\$739.00	\$779.00	\$795.00
AM33	-	Storeroom	\$739.00	\$779.00	\$795.00
AM34	-	Storeroom	\$743.00	\$783.00	\$799.00
AM37	F32	Classroom	\$739.00	\$779.00	\$795.00

- Specify HTHB trim design for large 3-1/4" diameter rose and add \$14.00 to list price.

AM Series Knob Designs



HTG

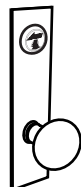

HTH

Non-Keyed Functions

Function	ANSI	Description	26D	03, 04, 10, 10B, 10BE, 26	32D
AM01	F01	Passage	\$536.00	\$576.00	\$592.00
AM02	F19	Privacy	\$608.00	\$648.00	\$664.00
AM07	F31	Exit	\$612.00	\$632.00	\$640.00
AM26	F22	Privacy	\$608.00	\$648.00	\$664.00
AM08	-	Single Dummy	\$252.00	\$272.00	\$280.00
AM09	-	Full Dummy	\$469.00	\$509.00	\$525.00

Single Cylinder Functions

Function	ANSI	Description	26D	03, 04, 10, 10B, 10BE, 26	32D
AM11	F12	Apartment	\$708.00	\$748.00	\$764.00
AM12	F07	Storeroom	\$701.00	\$741.00	\$757.00
AM13	F21	Front Door	\$708.00	\$748.00	\$764.00
AM17	F05	Classroom	\$701.00	\$741.00	\$757.00
AM19	F13	Dormitory	\$708.00	\$748.00	\$764.00
AM20	F20	Entrance	\$708.00	\$748.00	\$764.00
AM21	F08/F10	Entrance	\$708.00	\$748.00	\$764.00
AM22	F04	Office	\$701.00	\$741.00	\$757.00
AM23	-	Vestibule	\$701.00	\$741.00	\$757.00
AM24	-	Storeroom	\$701.00	\$741.00	\$757.00
AM27	-	Institutional Privacy	\$701.00	\$741.00	\$757.00

Double Cylinder Functions

Function	ANSI	Description	26D	03, 04, 10, 10B, 10BE, 26	32D
AM31	F14	Storeroom	\$735.00	\$775.00	\$791.00
AM32	F09	Vestibule	\$731.00	\$771.00	\$787.00
AM33	F30	Storeroom	\$731.00	\$771.00	\$787.00
AM34	F35	Storeroom	\$735.00	\$775.00	\$791.00
AM37	F32	Classroom	\$731.00	\$771.00	\$787.00

AM Series Knob Designs

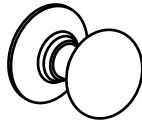

TA

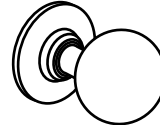

BD

Non-Keyed Functions

Function	ANSI	Description	26D	03, 04, 10, 10B, 10BE, 26
AM01	F01	Passage	\$426.00	\$466.00
AM02	F19	Privacy	\$498.00	\$538.00
AM07	-	Exit	\$557.00	\$577.00
AM26	F22	Privacy	\$498.00	\$538.00

Single Cylinder Functions

Function	ANSI	Description	26D	03, 04, 10, 10B, 10BE, 26
AM11	F12	Apartment	\$598.00	\$638.00
AM12	F07	Storeroom	\$591.00	\$631.00
AM13	F21	Front Door	\$598.00	\$638.00
AM17	F05	Classroom	\$591.00	\$631.00
AM19	F13	Dormitory	\$598.00	\$638.00
AM20	F20	Entrance	\$598.00	\$638.00
AM21	F08/F10	Entrance	\$598.00	\$638.00
AM22	F04	Office	\$591.00	\$631.00
AM23	-	Vestibule	\$591.00	\$631.00
AM24	-	Storeroom	\$591.00	\$631.00
AM27	-	Institutional Privacy	\$591.00	\$631.00

Double Cylinder Functions

Function	ANSI	Description	26D	03, 04, 10, 10B, 10BE, 26
AM31	F14	Storeroom	\$625.00	\$665.00
AM32	F09	Vestibule	\$621.00	\$661.00
AM33	-	Storeroom	\$621.00	\$661.00
AM34	-	Storeroom	\$625.00	\$665.00
AM37	F32	Classroom	\$621.00	\$661.00

AM Series Knob Designs & Deadlocks

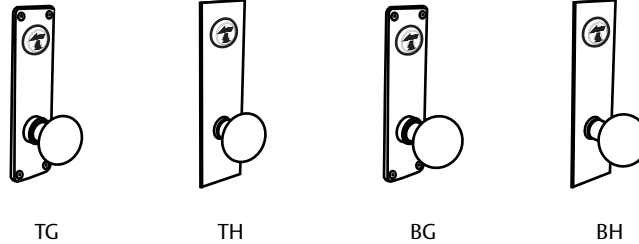

Non-Keyed Functions

Function	ANSI	Description	26D	03, 04, 10, 10B, 10BE, 26
AM01	F01	Passage	\$444.00	\$484.00
AM02	F19	Privacy	\$516.00	\$556.00
AM07	-	Exit	\$566.00	\$586.00
AM26	F22	Privacy	\$516.00	\$556.00
AM08	-	Single Dummy	\$206.00	\$226.00
AM09	-	Full Dummy	\$377.00	\$417.00

Single Cylinder Functions

Function	ANSI	Description	26D	03, 04, 10, 10B, 10BE, 26
AM11	F12	Apartment	\$616.00	\$656.00
AM12	F07	Storeroom	\$609.00	\$649.00
AM13	F21	Front Door	\$616.00	\$656.00
AM17	F05	Classroom	\$609.00	\$649.00
AM19	F13	Dormitory	\$616.00	\$656.00
AM20	F20	Entrance	\$616.00	\$656.00
AM21	F08/F10	Entrance	\$616.00	\$656.00
AM22	F04	Office	\$609.00	\$649.00
AM23	-	Vestibule	\$609.00	\$649.00
AM24	-	Storeroom	\$609.00	\$649.00
AM27	-	Institutional Privacy	\$609.00	\$649.00

Double Cylinder Functions

Function	ANSI	Description	26D	03, 04, 10, 10B, 10BE, 26
AM31	F14	Storeroom	\$643.00	\$683.00
AM32	F09	Vestibule	\$639.00	\$679.00
AM33	-	Storeroom	\$639.00	\$679.00
AM34	-	Storeroom	\$643.00	\$683.00
AM37	F32	Classroom	\$639.00	\$679.00

Deadlock Functions (No Trim)

Function	ANSI	Description	03, 04, 10, 10B, 10BE, 26, 26D
AM40	F18	Cylinder One Side	\$432.00
AM41	F17	Cylinder x Thumbturn	\$456.00
AM42	F16	Double Cylinder	\$480.00
AM44	-	Classroom - Cylinder x Thumbturn	\$456.00

BM Series

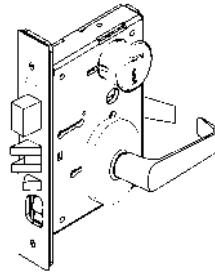

Features

Certification	BHMA A156.13, Series 1000, Operations Grade 1, UL Listed
Door Thickness	1-3/4"
Strike	Standard: ANSI 1-1/4" x 4-7/8", straight lip, with box; curved lip available
Latch	3/4" throw, stainless steel
Bolt	1" throw, stainless steel
Backset	2-3/4"
Cylinder	Standard: 6-pin, solid brass, 2 nickel-silver keys; IC prep available
Handing	Handed, field reversible without disassembling lock case
Case Quantity	10
Average Case Weight	62 lbs.
Warranty	5 years

Available Finishes	Arrow Code	BHMA Code	U.S. Code
Bright brass	03	605	US3
Satin brass	04	606	US4
Satin bronze	10	612	US10
Dark oxidized satin bronze, oil rubbed	10B	613	US10B
Dark oxidized satin bronze, equivalent	10BE	613E	US10BE
Bright chromium plated	26	625	US26
Satin chromium plated	26D	626	US26D
Bright stainless steel	32	629	US32
Satin stainless steel	32D	630	US32D

How to Order

Function	BM11
Trim	BM11-XL
Finish	BM11-XL-26D
Strike	BM11-XL-26D-460
Handing	BM11-XL-26D-460-RH
Keying	BM11-XL-26D-460-RH-KD-AR

BM Series Lever Designs



BRL



HSL



NL

Non-Keyed Functions

Function	ANSI	Description	26D	03, 04, 10, 10B, 10BE, 26	32, 32D
BM01	F01	Passage	\$449.00	\$491.00	\$503.00
BM02	F19	Privacy	\$513.00	\$555.00	\$567.00
BM07	-	Exit	\$563.00	\$584.00	\$590.00
BM26	F22	Privacy	\$513.00	\$555.00	\$567.00
BM08	-	Single Dummy	\$188.00	\$209.00	\$215.00
BM09	-	Full Dummy	\$354.00	\$396.00	\$408.00

Single Cylinder Functions

Function	ANSI	Description	26D	03, 04, 10, 10B, 10BE, 26	32, 32D
BM11	F12	Apartment	\$587.00	\$629.00	\$641.00
BM12	F07	Storeroom	\$569.00	\$611.00	\$623.00
BM13	F21	Front Door	\$587.00	\$629.00	\$641.00
BM17	F05	Classroom	\$569.00	\$611.00	\$623.00
BM19	F13	Dormitory	\$587.00	\$629.00	\$641.00
BM20	F20	Entrance	\$587.00	\$629.00	\$641.00
BM21	F08/F10	Entrance	\$587.00	\$629.00	\$641.00
BM22	F04	Office	\$569.00	\$611.00	\$623.00
BM23	-	Vestibule	\$569.00	\$611.00	\$623.00
BM24	-	Storeroom	\$569.00	\$611.00	\$623.00
BM27	-	Institutional Privacy	\$569.00	\$611.00	\$623.00

Double Cylinder Functions

Function	ANSI	Description	26D	03, 04, 10, 10B, 10BE, 26	32, 32D
BM31	F14	Storeroom	\$630.00	\$672.00	\$684.00
BM32	F09	Vestibule	\$613.00	\$655.00	\$667.00
BM33	-	Storeroom	\$613.00	\$655.00	\$667.00
BM34	-	Storeroom	\$630.00	\$672.00	\$684.00
BM37	F32	Classroom	\$613.00	\$655.00	\$667.00
BM38	-	Classroom Security	\$695.00	\$737.00	\$749.00

BM Series Lever Designs

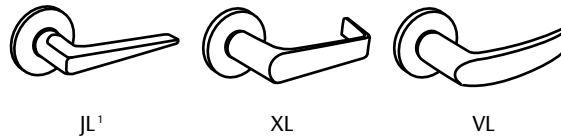

Non-Keyed Functions

Function	ANSI	Description	26D	03, 04, 10, 10B, 10BE, 26	32, 32D
BM01	F01	Passage	\$543.00	\$585.00	\$597.00
BM02	F19	Privacy	\$607.00	\$649.00	\$661.00
BM07	-	Exit	\$610.00	\$631.00	\$637.00
BM26	F22	Privacy	\$607.00	\$649.00	\$661.00
BM08	-	Single Dummy	\$235.00	\$256.00	\$262.00
BM09	-	Full Dummy	\$448.00	\$490.00	\$502.00

Single Cylinder Functions

Function	ANSI	Description	26D	03, 04, 10, 10B, 10BE, 26	32, 32D
BM11	F12	Apartment	\$681.00	\$723.00	\$735.00
BM12	F07	Storeroom	\$663.00	\$705.00	\$717.00
BM13	F21	Front Door	\$681.00	\$723.00	\$735.00
BM17	F05	Classroom	\$663.00	\$705.00	\$717.00
BM19	F13	Dormitory	\$681.00	\$723.00	\$735.00
BM20	F20	Entrance	\$681.00	\$723.00	\$735.00
BM21	F08/F10	Entrance	\$681.00	\$723.00	\$735.00
BM22	F04	Office	\$663.00	\$705.00	\$717.00
BM23	-	Vestibule	\$663.00	\$705.00	\$717.00
BM24	-	Storeroom	\$663.00	\$705.00	\$717.00
BM27	-	Institutional Privacy	\$663.00	\$705.00	\$717.00

Double Cylinder Functions

Function	ANSI	Description	26D	03, 04, 10, 10B, 10BE, 26	32, 32D
BM31	F14	Storeroom	\$724.00	\$766.00	\$778.00
BM32	F09	Vestibule	\$707.00	\$749.00	\$761.00
BM33	-	Storeroom	\$707.00	\$749.00	\$761.00
BM34	-	Storeroom	\$724.00	\$766.00	\$778.00
BM37	F32	Classroom	\$707.00	\$749.00	\$761.00
BM38	-	Classroom Security	\$789.00	\$831.00	\$843.00

¹ JL trim design not available in 32 or 32D finish.

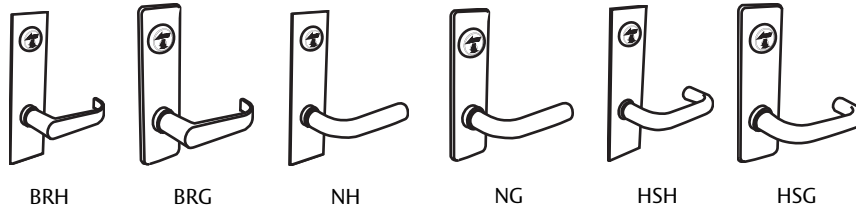

BM Series Lever Designs

Non-Keyed Functions

Function	ANSI	Description	26D	03, 04, 10, 10B, 10BE, 26	32, 32D
BM01	F01	Passage	\$493.00	\$535.00	\$547.00
BM02	F19	Privacy	\$557.00	\$599.00	\$611.00
BM07	-	Exit	\$585.00	\$606.00	\$612.00
BM26	F22	Privacy	\$557.00	\$599.00	\$611.00
BM08	-	Single Dummy	\$210.00	\$231.00	\$237.00
BM09	-	Full Dummy	\$398.00	\$440.00	\$452.00

Single Cylinder Functions

Function	ANSI	Description	26D	03, 04, 10, 10B, 10BE, 26	32, 32D
BM11	F12	Apartment	\$631.00	\$673.00	\$685.00
BM12	F07	Storeroom	\$613.00	\$655.00	\$667.00
BM13	F21	Front Door	\$631.00	\$673.00	\$685.00
BM17	F05	Classroom	\$613.00	\$655.00	\$667.00
BM19	F13	Dormitory	\$631.00	\$673.00	\$685.00
BM20	F20	Entrance	\$631.00	\$673.00	\$685.00
BM21	F08/F10	Entrance	\$631.00	\$673.00	\$685.00
BM22	F04	Office	\$613.00	\$655.00	\$667.00
BM23	-	Vestibule	\$613.00	\$655.00	\$667.00
BM24	-	Storeroom	\$613.00	\$655.00	\$667.00
BM27	-	Institutional Privacy	\$613.00	\$655.00	\$667.00

Double Cylinder Functions

Function	ANSI	Description	26D	03, 04, 10, 10B, 10BE, 26	32, 32D
BM31	F14	Storeroom	\$674.00	\$716.00	\$728.00
BM32	F09	Vestibule	\$657.00	\$699.00	\$711.00
BM33	-	Storeroom	\$657.00	\$699.00	\$711.00
BM34	-	Storeroom	\$674.00	\$716.00	\$728.00
BM37	F32	Classroom	\$657.00	\$699.00	\$711.00
BM38	-	Classroom Security	\$739.00	\$781.00	\$793.00

BM Series Lever Designs

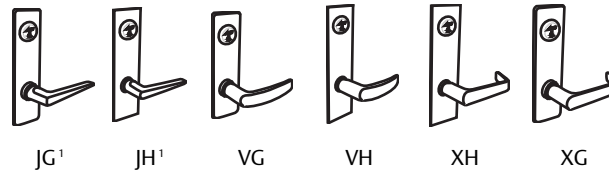

Non-Keyed Functions

Function	ANSI	Description	26D	03, 04, 10, 10B, 10BE, 26	32, 32D
BM01	F01	Passage	\$587.00	\$629.00	\$641.00
BM02	F19	Privacy	\$651.00	\$693.00	\$705.00
BM07	-	Exit	\$632.00	\$653.00	\$659.00
BM26	F22	Privacy	\$651.00	\$693.00	\$705.00
BM08	-	Single Dummy	\$257.00	\$278.00	\$284.00
BM09	-	Full Dummy	\$492.00	\$534.00	\$546.00

Single Cylinder Functions

Function	ANSI	Description	26D	03, 04, 10, 10B, 10BE, 26	32, 32D
BM11	F12	Apartment	\$725.00	\$767.00	\$779.00
BM12	F07	Storeroom	\$707.00	\$749.00	\$761.00
BM13	F21	Front Door	\$725.00	\$767.00	\$779.00
BM17	F05	Classroom	\$707.00	\$749.00	\$761.00
BM19	F13	Dormitory	\$725.00	\$767.00	\$779.00
BM20	F20	Entrance	\$725.00	\$767.00	\$779.00
BM21	F08/F10	Entrance	\$725.00	\$767.00	\$779.00
BM22	F04	Office	\$707.00	\$749.00	\$761.00
BM23	-	Vestibule	\$707.00	\$749.00	\$761.00
BM24	-	Storeroom	\$707.00	\$749.00	\$761.00
BM27	-	Institutional Privacy	\$707.00	\$749.00	\$761.00

Double Cylinder Functions

Function	ANSI	Description	26D	03, 04, 10, 10B, 10BE, 26	32, 32D
BM31	F14	Storeroom	\$768.00	\$810.00	\$822.00
BM32	F09	Vestibule	\$751.00	\$793.00	\$805.00
BM33	-	Storeroom	\$751.00	\$793.00	\$805.00
BM34	-	Storeroom	\$768.00	\$810.00	\$822.00
BM37	F32	Classroom	\$751.00	\$793.00	\$805.00
BM38	-	Classroom Security	\$833.00	\$875.00	\$887.00

¹ JH & JG trim designs not available in 32 or 32D finish.

AM & BM Series Options

Strike Options	Lock Function	Specify	Price Add
Straight lip	02, 11, 13, 19, 20, 21, 31, 34, 38	460	Standard
Straight lip	01, 07, 12, 17, 22, 23, 24, 26, 27, 32, 33, 37	463	Standard
Straight lip	40, 41, 42, 44	456	Standard
Curved lip	Optional strike for 01, 07, 12, 17, 22, 23, 24, 26, 27, 32, 33, 37	462 (LH, RR) 464 (RH, LR)	No Add
Curved lip	Optional strike for 02, 11, 13, 19, 20, 21, 31, 34	466 (LH, RR) 468 (RH, LR)	No Add

Note: Straight Lip Strike = 1-1/8" Lip-to-Center

Curved Lip Strike = 1-1/4" Lip-to-Center

Keying & Cylinder Options	Specify	Price Add
Keyed different	KD	Standard
Master keyed	MK	\$13.00 per cylinder
Construction master keyed	CMK	\$8.16 per cylinder
Master keyed & construction master keyed	MK-CMK	\$21.16 per cylinder
O-Bitted	OB	No Add
Less cylinder	LC	-\$13.35
Lock prepared to accept 6-pin IC cylinder, less core	IC6	No Add
Lock prepared to accept 7-pin IC cylinder, less core	IC7	No Add

Miscellaneous Options	Specify	Price Add
Abrasive outside lever (BM Series)	113	\$58.40
Abrasive inside lever (BM Series)	114	\$58.40
Knurled outside lever (BM Series)	103	\$82.30
Knurled inside lever (BM Series)	104	\$82.30
Lead lined case	123	\$139.00
Lead lined knobs (inside & outside)	127	\$277.00
Lead lined roses (inside & outside)	133	\$208.00
Rabbeted front and strike	144	\$106.00
Hold back latch for 12 function	HB	\$56.65
Security Head Screws	SHS ²	\$14.43

²Only available for locks in 26, 26D, 32, or 32D finish. Not available for T Knob, B Knob, or any escutcheon design.

NOTE: Arrow mortise locks are designed for standard 1-3/4" door applications. See *Non-Cataloged Products* in the *Terms & Conditions of Sale* section for additional details.

AM & BM Series Options

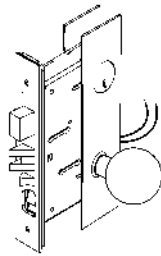

AM Series

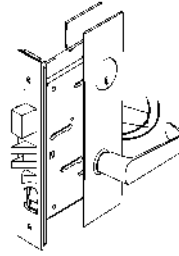

BM Series

Electrification Options (extended lead time required)

Description	Voltage	Specify	Price Add ¹
Fail-safe trim control (applied to 17 function)	12V AC/DC	177	\$472.00
	24V AC/DC	179	\$472.00
Fail-secure trim control (applied to 17 function)	12V AC/DC	181	\$472.00
	24V AC/DC	183	\$472.00
Latchbolt monitoring		LM ²	\$273.00
Request to exit - authorized		RE	\$273.00
Security monitoring		SM ²	\$515.00

¹ Electrification charges do not include price of locksets.

² LM and SM options cannot be combined.

Fail-safe Power on locks outside lever
 Inside lever always free
 Latch retracted by keys when locked electrically

Fail-secure Power off locks outside lever
 Inside lever always free
 Latch retracted by keys when locked electrically

Latchbolt monitoring
 Full extension of the latch monitored by a SPDT switch

Request to exit - authorized egress
 Inside trim monitored by an SPTD switch. Switch can be used to shunt a door alarm to allow egress, signal a control console when the trim is activated, or activate a door alarm.

Security monitoring
 Monitors, in series, solenoid status (locked or unlocked) and latch status (deadlatch position).

Specifications 12VAC/VDC @ 612mA
 24VAC/VDC @ 330mA

AM & BM Series Parts

Strikes	Lock Function	Specify Finish	Part No.	Price
Straight lip	02, 11, 13, 19, 20, 21, 31, 34, 38	•	460	\$33.36
Straight lip	01, 07, 12, 17, 22, 23, 24, 26, 27, 32, 33, 37	•	463	\$33.36
Straight lip	40, 41, 42, 44	•	456	\$33.36
Curved lip	01, 07, 12, 17, 22, 23, 24, 26, 27, 32, 33, 37	•	462 (LH, RR)	\$33.36
			464 (RH, LR)	
Curved lip	02, 11, 13, 19, 20, 21, 31, 34, 38	•	466 (LH, RR)	\$33.36
			468 (RH, LR)	
Box Strike	For all strikes above		BX70	\$5.08

Cylinders & Related	Specify Finish	Part No.	Price
Standard mortise cylinder	•	MC61-001	\$40.12
		MC61-AM2	\$40.12
Emergency key for privacy function		16L-207	\$1.84
Cylinder cams	For functions 12, 17, 22, 23, 24, 27, 32 (I/S), 33, 37	001	\$3.47
	For functions 11, 13, 19, 20, 21, 31, 32 (O/S), 34, 38, 40, 41, 42, 44	AM2	\$3.47
Cylinder collar & spring	•	16-113A	\$9.24
Mortise housing to accept 6-pin IC cylinder, less core	•	16CR-16X001	\$39.34
		16CR-16XAM2	\$39.34
Mortise housing to accept 7-pin IC cylinder, less core	•	16CR-27X001	\$39.34
		16CR-27XAM2	\$39.34
Housing cams	For functions 12, 17, 22, 23, 24, 27, 32 (I/S), 33, 37	16CR-001	\$3.47
	For functions 11, 13, 19, 20, 21, 31, 32 (O/S), 34, 38, 40, 41, 42, 44	16CR-AM2	\$3.47

AM & BM Series Parts

Parts & Accessories

Description	Lock Function	Specify Finish	Part No.	Price
Faceplates	01, 24, 26	•	AM01-305	\$30.03
	02, 13, 19, 31	•	AM02-305	\$30.03
	07, 12, 17, 27, 32, 33, 37	•	AM12-305	\$30.03
	11, 21, 34	•	AM11-305	\$30.03
	38	•	AM15-305	\$30.03
	20	•	AM20-305	\$30.03
	22	•	AM22-305	\$30.03
	23	•	AM23-305	\$30.03
	40, 41, 42, 44	•	AM41-305	\$30.03
Spindles	AM trim with H escutcheon		AM-385A	\$20.07
	AM trim with G escutcheon or rose trim		AM-386A	\$23.45
	BM trim with H escutcheon or rose trim		BM-385A	\$20.07
	BM trim with G escutcheon		BM-386A	\$23.45
Thumbturn for sectional trim		•	16-17A	\$21.76
Emergency rose for privacy function with sectional trim		•	16-04A	\$10.09
Emergency key for privacy function			16L-207	\$1.84
BM Series rose			17-03-2	\$32.52
Stud for mounting plate			BM-94	\$0.89
Mounting plate for lever x rose trim			BM-93A	\$9.24
Standard screw pack		•	AM-201	\$2.60
Supplement screw pack for G escutcheon		•	AM-201G	\$0.99
Supplement screw pack for H escutcheon		•	AM-201H	\$0.99
Faceplate screw			16-306	\$0.39
Black nylon bushing insert			16-14	\$0.84
Lever handle set screw			17-388	\$0.89

AM & BM Series Lockbodies

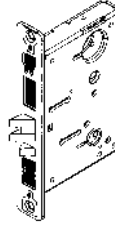

Mortise Locks

Lockbodies	Lock Function (specify handing - RH, LH, RR, or LR)	Part No.	Price
	01	AM01-LB	\$213.00
	02, 19	AM02-LB	\$295.00
	07, 12	AM12-LB	\$282.00
	11	AM11-LB	\$295.00
	13, 31	AM13-LB	\$295.00
	17, 32, 37	AM17-LB	\$282.00
For AM knobs	20	AM20-LB	\$295.00
	21, 34	AM21-LB	\$295.00
	22	AM22-LB	\$282.00
	23	AM23-LB	\$282.00
	24	AM24-LB	\$282.00
	26	AM26-LB	\$282.00
	27	AM27-LB	\$282.00
	33	AM33-LB	\$282.00
For deadlocks less trim	40, 41, 42	AM41-LB	\$272.00
	44	AM44-LB	\$272.00
	01	BM01-LB	\$213.00
	02, 19	BM02-LB	\$295.00
	07, 12	BM12-LB	\$282.00
	11	BM11-LB	\$295.00
	13, 31	BM13-LB	\$295.00
	17, 32, 37	BM17-LB	\$282.00
For BM levers	20	BM20-LB	\$295.00
	21, 34	BM21-LB	\$295.00
	22	BM22-LB	\$282.00
	23	BM23-LB	\$282.00
	24	BM24-LB	\$282.00
	26	BM26-LB	\$282.00
	27	BM27-LB	\$282.00
	33	BM33-LB	\$282.00
	38	BM38-LB	\$321.00

• Faceplates and screwpacks are not included with lockbodies.

AM Knob Trims

Trim Design	Lock Function	Suffix No.	26D	03, 04, 10, 10B, 10BE, 26	32D
HTHA, HTHD	01, 12, 17, 22, 23, 24, 31, 32, 33, 34, 37	4	\$282.00	\$305.00	\$312.00
	11, 13, 19, 20, 21, 27	6	\$305.00	\$328.00	\$333.00
	02, 26	7	\$312.00	\$336.00	\$343.00
HTHB	01, 12, 17, 22, 23, 24, 31, 32, 33, 34, 37	4	\$298.00	\$320.00	\$328.00
	11, 13, 19, 20, 21, 27	6	\$320.00	\$343.00	\$350.00
	02, 26	7	\$328.00	\$355.00	\$361.00
HTG, HTH	01	3	\$282.00	\$305.00	\$312.00
	12, 17, 22, 23, 24	4	\$282.00	\$305.00	\$312.00
	31, 32, 33, 34, 37	5	\$282.00	\$305.00	\$312.00
	11, 13, 19, 20, 21, 27	6	\$305.00	\$328.00	\$333.00
	02, 26	7	\$312.00	\$336.00	\$343.00
TA, BD	01, 12, 17, 22, 23, 24, 31, 32, 33, 34, 37	4	\$218.00	\$223.00	
	11, 13, 19, 20, 21, 27	6	\$240.00	\$245.00	
	02, 26	7	\$250.00	\$255.00	
BG, BH, TG, TH	01	3	\$228.00	\$233.00	
	12, 17, 22, 23, 24	4	\$228.00	\$233.00	
	31, 32, 33, 34, 37	5	\$228.00	\$233.00	
	11, 13, 19, 20, 21, 27	6	\$250.00	\$255.00	
	02, 26	7	\$260.00	\$265.00	

- Example - HTHA trim for an "01" function: HTHA4 x finish.
- Trim packs are supplied less cylinder. Each pack includes inside & outside trims, spindle, turnpiece (where applicable), & mounting screws.

BM Lever Trims

Trim Design	Lock Function	Suffix No.	26D	03, 04, 10, 10B, 10BE, 26	32, 32D
BRL, HSL, NL	01, 12, 17, 22, 23, 24, 31, 32, 33, 34, 37, 38	4	\$265.00	\$288.00	\$305.00
	11, 13, 19, 20, 21, 27	6	\$288.00	\$312.00	\$328.00
	02, 26	7	\$298.00	\$320.00	\$336.00
JL ¹ , VL, XL	01, 12, 17, 22, 23, 24, 31, 32, 33, 34, 37, 38	4	\$328.00	\$350.00	\$368.00
	11, 13, 19, 20, 21, 27	6	\$350.00	\$368.00	\$388.00
	02, 26	7	\$361.00	\$380.00	\$398.00
BRG, BRH, NG, NH, HSG, HSH	01	3	\$282.00	\$305.00	\$320.00
	12, 17, 22, 23, 24	4	\$282.00	\$305.00	\$320.00
	31, 32, 33, 34, 37, 38	5	\$282.00	\$305.00	\$320.00
	11, 13, 19, 20, 21, 27	6	\$305.00	\$328.00	\$343.00
	02, 26	7	\$315.00	\$336.00	\$355.00
JG ¹ , JH ¹ , VG, VH, XG, XH	01	3	\$350.00	\$368.00	\$385.00
	12, 17, 22, 23, 24	4	\$350.00	\$368.00	\$385.00
	31, 32, 33, 34, 37, 38	5	\$350.00	\$368.00	\$385.00
	11, 13, 19, 20, 21, 27	6	\$368.00	\$391.00	\$406.00
	02, 26	7	\$380.00	\$401.00	\$416.00

- Example - BRL trim for an "01" function: BRL4 x finish
 - Trim packs are supplied less cylinder. Each pack includes inside & outside trims, spindle, turnpiece (where applicable), & mounting screws.
- ¹ JL, JG, & JH trim designs not available in 32 or 32D finish.

QL Series

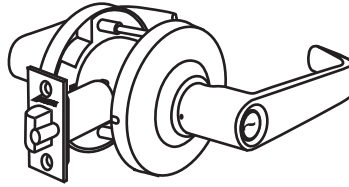

Features

Certification	BHMA A156.2, Series 4000, Grade 1, UL Listed
Freewheeling Lever Action	Standard
Door Thickness	Fits 1-3/8" to 1-3/4", factory set for 1-3/4"
Strike	ANSI 1-1/4" x 4-7/8"
Latch	2-3/4" backset, 1-1/8" front
Cylinder	Standard 6 Pin, solid brass, 2 nickel-plated brass keys, IC prep available
Handing	Non-handed
Case Quantity	6 per case
Average Case Weight	27 lbs.
Warranty	10 years

Available Finishes	Arrow Code	BHMA Code	U.S. Code
Bright Brass	03	605	US3
Dark Oxidized Satin Bronze, equivalent	613E	613E	US10BE
Satin Chromium Plated	26D	626	US26D

How to Order

Function & Trim	QL81-SB
Finish	QL81-SB-26D
Strike	QL81-SB-26D-306
Latch	QL81-SB-26D-306-Q71
Keying	QL81-SB-26D-306-Q71-ARKD

Function	Description	03, 613E, 26D
QL01-SB	Passage	\$191.00
QL72-SB	Privacy	\$222.00
QL81-SB	Entrance	\$248.00
QL82-SB	Storeroom	\$248.00
QL87-SB	Classroom	\$248.00
QL97-SB	Classroom Intruder	\$309.00

*** AVAILABLE THROUGH SELECT DISTRIBUTORS – CONTACT ARROW LOCK FOR MORE INFORMATION ***		
Rigid Lever Function	Description	03, 613E, 26D
QL02-SB	Privacy	\$222.00
QL11-SB	Entrance	\$248.00
QL12-SB	Storeroom	\$248.00
QL17-SB	Classroom	\$248.00
QL33-SB	Asylum	\$284.00
QL37-SB	Classroom Intruder	\$309.00
Freewheeling Function	Description	03, 613E, 26D
QL93-SB	Asylum	\$284.00
Specify SR trim for QL design with removable thru-bolts.		

QL Series Options & Parts

Keying & Cylinder Options	Specify	Price Add
Keyed different, AR keyway	ARKD	Standard
Keyed different, CS keyway	CSKD	No Add
Lock prepared to accept a 6- or 7-pin SFIC cylinder (not included)	IC	No Add
Lock prepared to accept Schlage LFIC cylinder (not included)	SIC ¹	\$25.00
Lock prepared to accept a Medeco 320201 or ASSA LFIC cylinder (not included)	LIC	\$25.00

¹ Not available with 10BP finish, 03 finish, or the QL97 function.

Latch Options	Spring Latch	Dead Latch	Price Add
2-3/4" backset x 1-1/8" front	Q73	Q71	Standard

Parts	Part No.	Price
Standard cylinder with tailpiece – AR keyway	700HD	\$25.75
Standard cylinder with tailpiece – CS keyway	700HD-CS	\$25.75
Strike	306	\$26.71
Latch - 2-3/4" backset	Q73 ² or Q71 ³	\$21.29
Latch - 2-3/8" backset (sold only as a separate part)	R22 ^{2,4} or R20 ^{3,4}	\$15.59
Screw pack	QL-201	\$1.89
IC tailpiece kit (tailpiece & spacer for 6- & 7- pin cores)	RLX-44-201	\$5.03
SIC Tailpiece	QL-44S	\$14.06
LIC tailpiece	QL-44	\$3.17
LIC tailpiece retainer	QL-66	\$0.44
Classroom intruder rose	QL97-03A.26D	\$32.45

¹ Not available with 10BP finish, 03 finish, or QL97 function.

² Used only with non-keyed functions.

³ Used only with non-keyed functions.

⁴ Sold only as a separate part. Not tested to grade 1 specifications. If substituted for standard latch, grade 1 rating is voided.

GL Series

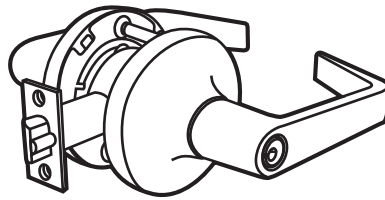

Features

Certification	BHMA A156.2, Series 4000, Grade 1, UL Listed
Door Thickness	Fits 1-3/4" - 2", factory set for 1-3/4"
Strike	ANSI 1-1/4" x 4-7/8"
Latch	2-3/4" backset, 1-1/8" front
Cylinder	Standard: 6-pin, solid brass, 2 brass keys; IC prep available
Handing	Non-handed
Case Quantity	6
Average Case Weight	31 lbs.
Warranty	5 years

Available Finishes	Arrow Code	BHMA Code	U.S. Code
Bright Brass	03	605	US3
Dark Oxidized Satin Bronze, Oil Rubbed	10B	613	US10B
Satin Chromium Plated	26D	626	US26D

How to Order

Function & Trim	GL81-SR
Finish	GL81-SR-26D
Strike	GL81-SR-26D-306
Latch	GL81-SR-26D-306-G71
Keying	GL81-SR-26D-306-G71-KD-AR

Function	ANSI	Description	03, 26D	10B
GL01-SR	F75	Passage	\$210.00	\$226.00
GL02-SR	F76	Privacy	\$245.00	\$261.00
GL08-SR	-	Single Dummy	\$112.00	\$120.00
GL81-SR	F109	Entrance	\$272.00	\$288.00
GL82-SR	F86	Storeroom	\$272.00	\$288.00
GL87-SR	F84	Classroom	\$272.00	\$288.00
GL97-SR	F110	Classroom Intruder	\$342.00	\$358.00

GL Series Options & Parts

Cylindrical Locks

Strike & Latch Options	Specify	Price Add
ANSI Strike	306	Standard
Latch (keyed functions) - 2-3/4" backset, 1-1/8" front	G71	Standard
Latch (non-keyed functions) - 2-3/4" backset, 1-1/8" front	G73	Standard

Keying & Cylinder Options	Specify	Price Add
Keyed different	KD	Standard
Master keyed	MK	\$13.00 per cylinder
Construction master keyed	CMK	\$8.16 per cylinder
Master keyed & construction master keyed	MK-CMK	\$21.16 per cylinder
Keyed alike	KA	No Add
O-Bitted	OB	No Add
Less cylinder	LC	-\$8.55
Lock prepared to accept 6 or 7-pin SFIC cylinder, less core	IC	No Add

*LC option no longer available for this product. Please refer to the QL Series.

Parts	Part No.	Price
ANSI Strike	306	\$26.71
Standard dead latch (for keyed functions)	G71	\$21.29
Standard spring latch (for passage & privacy functions)	G73	\$21.29
Standard cylinder w/tailpiece	600HD-GL	\$25.75
Standard keyblank	K6A	\$1.29
Standard tailpiece	1001GL-44	\$2.60

Alternate Latches (sold only as separate parts)

Backset	Description	Specify >>>	Spring Latch	Dead Latch	Price
2-3/8" Backset	1" front		G72	G70	\$21.29
3-3/4" Backset	1-1/8" front		G83	G81	\$27.15
5" Backset	1-1/8" front		G93	G91	\$31.66

HK Series

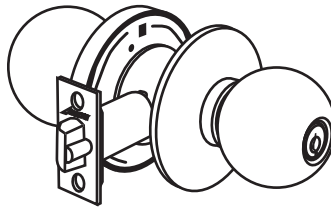

Cylindrical Locks

Features

Certification	BHMA A156.2, Series 4000, Grade 1, UL Listed
Door Thickness	Fits 1-3/8" to 2" factory set to 1-3/4"
Strike	ANSI 1-1/4" x 4-7/8"
Latch	2-3/4" backset, 1-1/8" front
Cylinder	Standard 6 Pin, solid brass, 2 nickel-plated brass keys, IC prep available
Handing	Non-handed
Case Quantity	16
Average Case Weight	32 lbs.
Warranty	10 years

Available Finishes	Arrow Code	BHMA Code	U.S. Code
Bright Brass	605	605	US3
Dark Oxide Satin Bronze, equivalent	613E	613E	US10BE
Satin Stainless Steel	630	630	US32D

How to Order

Function & Trim	HK11-BB
Finish	HK11-BB-630
Strike	HK11-BB-630-306
Latch	HK11-BB-630-306-Q71
Keying	HK11-BB-630-306-Q71-ARKD

Function	Description	605, 613E, 630
HK01-BB	Passage	\$201.00
HK02-BB	Privacy	\$244.00
HK08-BB	Single Dummy	\$120.00
HK11-BB	Entrance	\$287.00
HK12-BB	Storeroom	\$287.00
HK17-BB	Classroom	\$287.00
HK33-BB	Asylum	\$314.00

Keying & Cylinder Options	Specify	Price Add
Keyed different, AR keyway	ARKD	Standard
Keyed different, CS keyway	CSKD	No Add
Lock prepared to accept a 6- or 7-pin SFIC cylinder (not included)	IC	No Add

Latch Options	Spring Latch	Dead Latch	Price Add
2-3/4" backset x 1-1/8" front	Q73	Q71	Standard

HK Series Parts

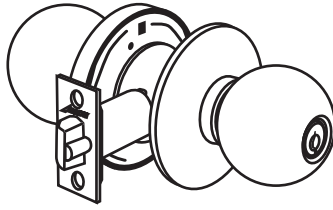

Parts	Part No.	Price
Standard cylinder with tailpiece – AR keyway	700HD	\$25.75
Standard cylinder with tailpiece – CS keyway	700HD-CS	\$25.75
Strike	306	\$26.71
Latch - 2-3/4" backset	Q73 ¹ or Q71 ²	\$21.29
Latch - 2-3/8" backset (sold only as a separate part)	R22 ^{1,3} or R20 ^{2,3}	\$15.59
Screw pack	HK-201	\$5.03
IC tailpiece kit (tailpiece & spacer for 6- & 7-pin cores)	RLX-44-201	\$5.03

¹ Used only with non-keyed functions.

² Used only with keyed functions.

³ Sold only as a separate part. Not tested to grade 1 specifications. If substituted for standard latch, grade 1 rating is voided.

MK Series

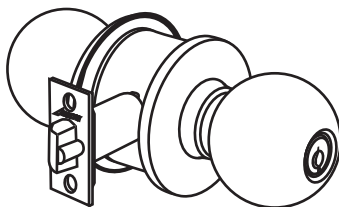

Features

Certification	BHMA A156.2, Series 4000, Grade 2, UL Listed
Door Thickness	Fits 1-3/8" - 1-3/4", factory set for 1-3/4"
Strike	Standard: T-strike, 1-1/8" x 2-3/4"; alternate strikes available
Latch	Standard: 2-3/4" backset, 1-1/8" front; alternate latches available
Cylinder	Standard: 6-pin, keyed 5, solid brass, 2 brass keys; IC prep available
Handing	Non-handed
Case Quantity	12
Average Case Weight	21 lbs.
Warranty	1 year

Available Finishes	Arrow Code	BHMA Code	U.S. Code
Bright brass	03	605	US3
Satin brass	04	606	US4
Antique brass	05A	609	US5
Satin bronze	10	612	US10
Dark oxidized satin bronze, oil rubbed	10B	613	US10B
Dark oxidized satin bronze, equivalent	10BE	613E	US10BE
Satin nickel	15	619	US15
Bright chromium plated	26	625	US26
Satin chromium plated	26D	626	US26D

How to Order

Function	MK11
Trim	MK11-TA
Finish	MK11-TA-26D
Strike	MK11-TA-26D-300
Latch	MK11-TA-26D-300-114
Keying	MK11-TA-26D-300-114-KD-AR

MK Series

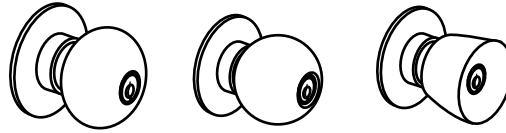

TA BD¹ DD¹

Non-Keyed Functions

Function	ANSI	Description	03, 26D	04, 05A, 10, 10B, 10BE, 15, 26
MK01	F75	Passage	\$80.00	\$90.00
MK02	F76	Privacy	\$85.00	\$95.00
MK03	F111	Communicating Passage	\$80.00	\$85.00
MK04	F77	Patio	\$86.00	\$96.00
MK05	F78	Communicating	\$117.00	\$127.00
MK08	-	Single Dummy	\$57.00	\$62.00

Single Cylinder Functions

Function	ANSI	Description	03, 26D	04, 05A, 10, 10B, 10BE, 15, 26
MK11	F109 (F81 & F82)	Entrance/Office	\$120.00	\$130.00
MK12	F86	Storeroom	\$120.00	\$130.00
MK13	F82	Exterior	\$120.00	\$130.00
MK14	F92	Service Station	\$136.00	\$146.00
MK15¹	F93	Hotel	\$190.00	\$200.00
MK17	F84	Classroom	\$136.00	\$146.00
MK18	F113	Communicating Classroom	\$120.00	\$125.00

Double Cylinder Functions

Function	ANSI	Description	03, 26D	04, 05A, 10, 10B, 10BE, 15, 26
MK31	F80	Communicating	\$206.00	\$216.00
MK32	F88	Public Entrance	\$206.00	\$216.00
MK33	F87	Asylum	\$206.00	\$216.00
MK34	-	Exterior	\$206.00	\$216.00

Prices below include: "TA" trim prepared for IC cylinder(s), ANSI strike, & UL latch	
03, 26D	04, 05A, 10, 10B, 10BE, 15, 26
\$183.10	\$193.10
\$183.10	\$193.10
\$183.10	\$193.10
\$199.10	\$209.10
\$253.10	\$263.10
\$199.10	\$209.10
\$183.10	\$188.10
03, 26D	04, 05A, 10, 10B, 10BE, 15, 26
\$269.10	\$279.10
\$269.10	\$279.10
\$269.10	\$279.10
\$269.10	\$279.10

¹ Not available with IC option.

Cylindrical Locks

MK Series Options

Strike Options	Description	Specify	Price Add
T-Strike	1-1/8" x 2-3/4", 1-1/4" lip, square corner, no box	300	Standard
ANSI ¹	1-1/4" x 4-7/8", 1-1/4" lip, square corner, no box	306 ¹	\$18.23
Full Lip D-Type	1-3/4" x 2-1/4", 1-1/4" lip, square corner	302	No Add
Radius D-Type	1-3/4" x 2-1/4", 1-1/4" lip, 1/4" radius corner	303	No Add
Box Strike	Supplied when specified	WBS	No Add

Latch Options	Description	Specify >>>	Spring Latch	Dead Latch	Price Add
2-3/4" Backset	1-1/8", square corner		104	114	Standard
	1-1/8", square corner, UL ¹		224 ¹	124 ¹	\$19.87
	1", square corner		102	112	\$4.37
	1", square corner, UL		222	122	\$19.87
	Drive-in		-	116	\$6.57
2-3/8" Backset	1", square corner		101	111	No Add
	1", square corner, UL		221	121	\$19.87
	1", round corner		109	-	\$4.37
	Drive-in		-	115	\$6.57
Less Latch			LAT		-\$3.90

Keying & Cylinder Options	Specify	Price Add
Keyed alike in four (quantity permitting otherwise KD)	KA4	Standard
Keyed different	KD	No Add
Master keyed	MK	\$13.00 per cylinder
Construction master keyed	CMK	\$8.16 per cylinder
Master keyed & construction master keyed	MK-CMK	\$21.16 per cylinder
O-Bitted	OB	No Add
Less Cylinder	LC	-\$8.55
TA design prepared to accept 6 or 7-pin SFIC cylinder, less core	IC ¹	\$25.00

¹ Unless otherwise specified, locksets requesting "IC" option will be provided with an ANSI strike and UL latch at additional costs shown above.

MK Series Parts

Strikes	Description	Specify Finish	Strike No.	Price
T-Strike	1-1/8" x 2-3/4", 1-1/4" lip, square corner	•	300	\$8.48
ANSI	1-1/4" x 4-7/8", 1-1/4" lip, square corner	•	306	\$26.71
Full Lip D-Type	1-3/4" x 2-1/4", 1-1/4" lip, square corner	•	302	\$8.48
Radius D-Type	1-3/4" x 2-1/4", 1-1/4" lip, 1/4" radius corner	•	303	\$8.48
Box Strike	Used with 306 ANSI strike		BX70	\$5.08
Box Strike	Used with 300, 302, or 303 strike		BX10	\$5.08

Latches	Description	Specify Finish	Spring Latch No.	Dead Latch No.	Price
2-3/4" Backset	1-1/8", square corner	•	104	114	\$11.79
	1-1/8", square corner, UL	•	224	124	\$31.66
	1", square corner	•	102	112	\$16.16
	1", square corner, UL	•	222	122	\$31.66
	Drive-in		-	116	\$18.36
2-3/8" Backset	1", square corner	•	101	111	\$11.79
	1", square corner, UL	•	221	121	\$31.66
	1", round corner	•	109	-	\$16.16
	Drive-in		-	115	\$18.36

Cylinder & Related	Specify Finish	Part No.	Price
Standard cylinder (except for B knob) (drilled 6, pinned 5)	•	100C	\$25.75
Standard cylinder for B knob (drilled 6, pinned 5)		100C-750	\$25.75
Alternate Cylinder (except for B knob) (drilled 6, pinned 6)	•	300C	\$25.75
Alternate Cylinder for B knob (drilled 6, pinned 6)		300C-750	\$25.75
Hotel cylinder	•	H100C	\$40.12
Standard keyblank		K5A	\$1.29
Standard tailpiece (except for B knob or hotel function)		550AM-44	\$2.60
Standard tailpiece for B knob (except hotel function)		750-44	\$2.60
Hotel function tailpiece (except for B knob)		550H-44	\$2.60
Hotel function tailpiece for B knob		750H-44	\$2.60
IC core cylinder - See Keys & Cylinders section		-	-
IC core tailpiece pack for 6- & 7-pin cores		550CR-44-201	\$5.03

MLX Series

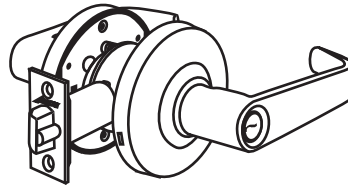

Features	
Certification	BHMA A156.2, Series 4000, Grade 2, UL Listed
Freewheeling Lever Action	Standard
Door Thickness	Fits 1-3/8" to 1-3/4", factory set for 1-3/4"
Strike	ANSI 1-1/4" x 4-7/8"
Latch	2-3/4" backset, 1-1/8" front
Cylinder	Standard: 6 Pin, solid brass, 2 nickel-plated brass keys; IC prep available
Handing	Non-handed
Case Quantity	6 per case
Average Case Weight	27 lbs.
Warranty	10 years

Available Finishes	Arrow Code	BHMA Code	U.S. Code
Bright Brass	03	605	US3
Dark Oxide Satin Bronze, equivalent	613E	613E	US10BE
Satin Chromium Plated	26D	626	US26D

How to Order	
Function & Trim	MLX81-SB
Finish	MLX81-SB-26D
Strike	MLX81-SB-26D-306
Latch	MLX81-SB-26D-306-R21
Keying	MLX81-SB-26D-306-R21-ARKD

Function	Description	03, 613E, 26D
MLX01-SB	Passage	\$119.00
MLX08-SB	Single Dummy	\$47.00
MLX72-SB	Privacy	\$129.00
MLX81-SB	Entrance/Office	\$140.00
MLX82-SB	Storeroom	\$140.00
MLX87-SB	Classroom	\$140.00
MLX93-SB (26D finish only)	Asylum	\$176.00

*** AVAILABLE THROUGH SELECT DISTRIBUTORS – CONTACT ARROW LOCK FOR MORE INFORMATION ***		
Rigid Lever Function	Description	03, 613E, 26D
MLX02-SB	Privacy	\$129.00
MLX11-SB	Entrance	\$140.00
MLX12-SB	Storeroom	\$140.00
MLX17-SB	Classroom	\$140.00
MLX33-SB	Asylum	\$176.00

Specify SR trim for MLX design with removable thru-bolts.

MLX Series Options & Parts

Keying & Cylinder Options	Specify	Price Add
Keyed different, AR keyway	ARKD	Standard
Keyed different, CS keyway	CSKD	No Add
Lock prepared to accept a 6- or 7-pin SFIC cylinder (not included)	IC	No Add
Lock prepared to accept Schlage LFIC cylinder (not included)	SIC ¹	\$25.00

¹Not available with 10BP or 03 finishes.

Strike & Latch Options	Spring Latch	Dead Latch	Price Add
2-3/4" backset x 1-1/8" front	R23	R21	Standard

Parts	Part No.	Price
Standard cylinder with tailpiece – AR keyway	700HD	\$25.75
Standard cylinder with tailpiece – CS keyway	700HD-CS	\$25.75
Strike	306	\$26.71
Latch - 2-3/4" backset	R23 ¹ or R21 ²	\$15.59
Screw pack	QL-201	\$1.89
IC tailpiece kit (tailpiece & spacer for 6- & 7- pin cores)	RLX-44-201	\$5.03
Alternate latch – 2-3/8" backset x 1" front (sold only as a separate part)	R22 ¹ or R20 ²	\$15.59

¹ Used only with non-keyed functions.

² Used only with keyed functions.

RK Series

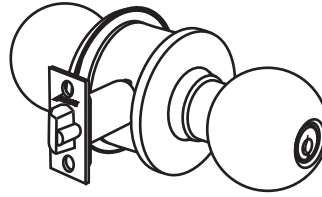

Features

Certification	BHMA A156.2, Series 4000, Grade 2, UL Listed
Door Thickness	Fits 1-3/8" - 1-3/4", factory set for 1-3/4"
Strike	Standard: T-strike, 1-1/8" x 2-3/4"; alternate strikes available
Latch	Standard: 2-3/8" backset, 1" front; alternate latches available
Cylinder	Standard: 6-pin, solid brass, 2 brass keys; IC prep available
Handing	Non-handed
Case Quantity	10
Average Case Weight	13 lbs.
Warranty	5 years

Available Finishes	Arrow Code	BHMA Code	U.S. Code
Bright Brass	03	605	US3
Satin Brass	04	606	US4
Satin Bronze	10	612	US10
Dark Oxidized Satin Bronze, Oil Rubbed	10B	613	US10B
Polished Stainless Steel	32	629	US32
Satin Stainless Steel	32D	630	US32D

How to Order

Function & Trim	RK11-BD
Finish	RK11-BD-32D
Strike	RK11-BD-32D-R60
Latch	RK11-BD-32D-R60-R70
Keying	RK11-BD-32D-R60-R70-KD-AR

Function	ANSI	Description	03, 32D	04, 10, 10B, 32
RK01	F75	Passage	\$48.00	\$58.00
RK02	F76A	Privacy	\$49.00	\$59.00
RK08	—	Single Dummy	\$18.00	\$23.00
RK11	F109	Entrance	\$54.00	\$64.00
RK12	F86	Storeroom	\$54.00	\$64.00
RK17	F84	Classroom	\$54.00	\$64.00

Less Cylinder (specify "LC" suffix)	
03, 32D	04, 10, 10B, 32
—	—
—	—
—	—
\$45.45	\$55.45
\$45.45	\$55.45
\$45.45	\$55.45

RL Series

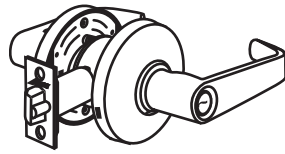

SR Trim

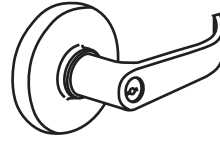

BRR Trim

Cylindrical Locks

Features

Certification	BHMA A156.2, Series 4000, Grade 2, UL Listed
Door Thickness	Fits 1-3/8" - 1-3/4", factory set for 1-3/4"
Strike	Standard: ANSI 1-1/4" x 4-7/8"; alternate strikes available
Latch	Standard: 2-3/4" backset, 1-1/8" front; alternate latches available
Cylinder	Standard: 6-pin, solid brass, 2 brass keys; IC prep available
Handing	Non-handed
Case Quantity	10
Average Case Weight	38 lbs.
Warranty	5 years

Available Finishes	Arrow Code	BHMA Code	U.S. Code
Bright Brass	03	605	US3
Satin Brass	04	606	US4
Satin Bronze	10	612	US10
Dark Oxidized Satin Bronze, Oil Rubbed	10B	613	US10B
Bright Chromium Plated	26	625	US26
Satin Chromium Plated	26D	626	US26D

How to Order

Function	RL11
Trim	RL11-SR
Finish	RL11-SR-26D
Strike	RL11-SR-26D-R62
Latch	RL11-SR-26D-R62-R71
Keying	RL11-SR-26D-R62-R71-KD-AR

Function	ANSI	Description	03, 26D	04, 10, 10B, 26
RL01	F75	Passage	\$91.00	\$101.00
RL02	F76A	Privacy	\$94.00	\$104.00
RL03	—	Communicating	\$94.00	\$99.00
RL08	—	Single Dummy	\$34.00	\$39.00
RL11	F109	Entrance	\$110.00	\$120.00
RL12	F86	Storeroom	\$110.00	\$120.00
RL17	F84	Classroom	\$110.00	\$120.00

Less Cylinder (specify "LC" suffix)	
03, 26D	04, 10, 10B, 26
—	—
—	—
—	—
—	—
\$101.45	\$111.45
\$101.45	\$111.45
\$101.45	\$111.45

RK & RL Series Options & Parts

Strike Options	Description	Specify	Price Add
T-Strike	1-1/8" x 2-3/4", 1-1/4" lip, square corner – standard with RK Series	R60	No Add
Square Corner	1-3/4" x 2-1/4", 1-1/4" lip, square corner – full lip	R61	No Add
ANSI	1-1/4" x 4-7/8", 1-1/4" lip, square corner – standard with RL Series	R62	No Add

Latch Options	Description	Specify>>>	Spring Latch No.	Dead Latch No.	Price Add
2-3/8" Backset	1", square corner – standard with RK Series		R72	R70	No Add
2-3/4" Backset	1-1/8", square corner – standard with RL Series		R73	R71	No Add

Keying & Cylinder Options	Specify	Price Add
Keyed different, AR Keyway	ARKD	Standard
Keyed different, CS Keyway	CSKD	No Add
Master Keyed	MK	\$13.00 per cylinder
Construction Master Keyed	CMK	\$8.16 per cylinder
Master Keyed & Construction Master Keyed	MK-CMK	\$21.16 per cylinder
Keyed Alike	KA	No Add
O-bitted	OB	No Add
Less Cylinder	LC	-\$8.55
Lock prepared to accept 6 or 7-pin SFIC Cylinder, less core	IC	No Add

Parts

Strikes	Description	Part No.	Price
T-Strike	1-1/8" x 2-3/4", 1-1/4" lip, square corner	R60	\$7.94
Square Corner	1-3/4" x 2-1/4", 1-1/4" lip, square corner	R61	\$7.94
ANSI	1-1/4" x 4-7/8", 1-1/4" lip, square corner	R62	\$25.21

Latches	Description	Spring Latch	Dead Latch	Price
2-3/8" Backset	1", square corner	R72	R70	\$16.16
	Drive-in ¹	R76	R74	\$16.16
2-3/4" Backset	1-1/8", square corner	R73	R71	\$16.16
	Drive-in ¹	R77	R75	\$16.16

Cylinders & Related	Part No.	Price	
RK Series	Standard cylinder	100C-RK	\$25.75
	Standard keyblank	K5A	\$1.29
	Standard tailpiece	550RK-44	\$2.60
	IC tailpiece pack for 6- & 7-pin cores	100CR-44-201	\$5.03
RL Series	Standard cylinder	600HD	\$25.75
	Standard keyblank	K6A	\$1.29
	Standard tailpiece	1001-44	\$2.60
	6-Pin IC core tailpiece	HSCR6-44	\$3.10
	7-Pin IC core tailpiece	HSCR7-44	\$3.10

¹ Sold only as a separate part; specify 26D or 03 finish.

CL Series

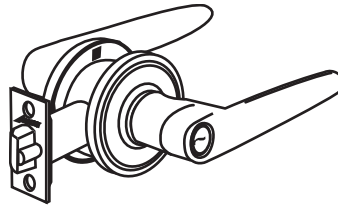

Cylindrical Locks

Features

Certification	BHMA A156.2, Series 4000, Grade 2
Door Thickness	Fits 1-3/8" - 1-3/4", factory set for 1-3/4"
Strike	Standard: Full lip 1-5/8" x 2-1/4"; alternate strikes available
Latch	Standard: 2-3/8" - 2-3/4" adj. backset, 1" front; alternate latches available
Cylinder	6-pin, solid brass, 2 brass keys
Handing	Non-handed
Case Quantity	20
Average Case Weight	38 lbs.
Warranty	5 years

Available Finishes	Arrow Code	BHMA Code	U.S. Code
Bright Brass	03	605	US3
Satin Brass	04	606	US4
Antique Brass	05A	609	US5
Satin Nickel	15	619	US15
Bright Chromium Plated	26	625	US26
Satin Chromium Plated	26D	626	US26D

How to Order

Function	CL11
Trim	CL11-SC
Finish	CL11-SC-26D
Strike	CL11-SC-26D-502
Latch	CL11-SC-26D-502-511
Keying	CL11-SC-26D-502-511-KD-AR



SC



LC¹



VC



OC¹

Function	Description	SC	VC	LC, OC
CL01	Passage	\$73.00	\$71.00	\$67.00
CL02	Privacy	\$79.00	\$77.00	\$73.00
CL04	Patio	\$78.00	\$76.00	\$72.00
CL08	Single Dummy	\$34.00	\$33.00	\$31.00
CL11	Entrance	\$103.00	\$101.00	\$97.00
CL12	Storeroom	\$103.00	\$101.00	\$97.00

¹ Handing required for LC & OC trim designs.

CL Series Options

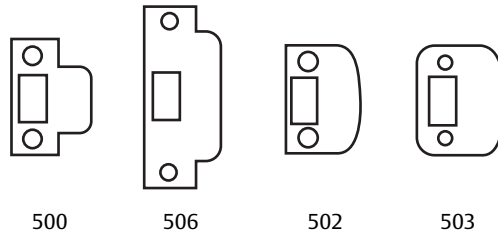

Strike Options	Description	Specify	Price Add
T-Strike	1-1/8" x 2-3/4", 1-1/4" lip, square corner	500	No Add
ANSI	1-1/4" x 4-7/8", 1-1/4" lip, square corner	506	\$8.06
Full Lip D-Type	1-3/4" x 2-1/4", 1-1/4" lip, square corner	502	Standard
Radius D-Type	1-3/4" x 2-1/4", 1-1/4" lip, 1/4" radius corner	503	No Add

Cylindrical Locks

Latch Options	Description	Specify >>>	Spring Latch	Dead Latch	Price Add
2-3/8" - 2-3/4"	Includes 3 faceplates		501	511	Standard
Adjustable Backset	Drive-in		505	515	No Add
Less Latch				LAT	-\$4.35

Keying & Cylinder Options	Specify	Price Add
Keyed alike in four (quantity permitting otherwise KD)	KA4	Standard
Keyed different	KD	No Add
Master keyed	MK	\$13.00 per cylinder
Construction master keyed	CMK	\$8.16 per cylinder
Master keyed & construction master keyed	MK-CMK	\$21.16 per cylinder
O-Bitted	OB	No Add
Less Cylinder	LC	-\$8.55

CL Series Parts

Strikes	Description	Specify Finish	Part No.	Price
T-Strike	1-1/8" x 2-3/4", 1-1/4" Lip, Square Corner	•	500	\$5.08
ANSI	1-1/4" x 4-7/8", 1-1/4" Lip, Square Corner	•	506	\$13.14
Full Lip D-Type	1-3/4" x 2-1/4", 1-1/4" Lip, Square Corner	•	502	\$5.08
Radius D-Type	1-3/4" x 2-1/4", 1-1/4" Lip, 1/4" Radius Corner	•	503	\$5.08

Latches	Description	Specify Finish	Spring Latch No.	Dead Latch No.	Price
2-3/8" - 2-3/4"	Includes 3 faceplates	•	501	511	\$13.14
Adjustable Backset	Drive-in		505	515	\$13.14

Cylinder & Related	Part No.	Price
Standard key blank	K5A	\$1.29
Standard cylinder for CL Series	100YC	\$25.75
Standard tailpiece for CL Series	10CL-44	\$2.60

Cylindrical Locks

RLX Series

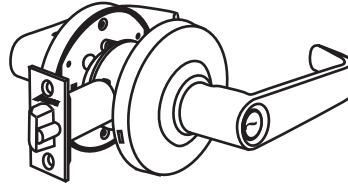

Cylindrical Locks

Features

Certification	BHMA A156.2, Series 4000, Grade 2, UL Listed
Freewheeling Lever Action	Standard
Door Thickness	Fits 1-3/8" to 1-3/4", factory set for 1-3/4"
Strike	ANSI 1-1/4" x 4-7/8"
Latch	2-3/4" backset, 1-1/8" front
Cylinder	Standard: 6-pin, solid brass, 2 nickel-plated brass keys; IC prep available
Handing	Non-handed
Case Quantity	6 per case
Average Case Weight	26 lbs.
Warranty	10 years

Available Finishes	Arrow Code	BHMA Code	U.S. Code
Bright Brass	03	605	US3
Dark Oxide Satin Bronze, equivalent	613E	613E	US10BE
Satin Chromium Plated	26D	626	US26D

How to Order

Function & Trim	RLX81-SR
Finish	RLX81-SR-26D
Strike	RLX81-SR-26D-306
Latch	RLX81-SR-26D-306-R21
Keying	RLX81-SR-26D-306-R21-ARKD

***** AVAILABLE THROUGH SELECT DISTRIBUTORS – CONTACT ARROW LOCK FOR MORE INFORMATION *****

Function	Description	03, 26D	613E
RLX01-SR	Passage	\$102.00	\$113.00
RLX08-SR	Single Dummy	\$39.00	\$44.00
RLX72-SR	Privacy	\$106.00	\$118.00
RLX81-SR	Entrance/Office	\$124.00	\$135.00
RLX82-SR	Storeroom	\$124.00	\$135.00
RLX87-SR	Classroom	\$124.00	\$135.00

RLX Series Options & Parts

Strike Option		Specify	Price Add
ANSI		306	Standard

Latch Options	Spring Latch	Dead Latch	Price Add
2-3/4" backset x 1-1/8" front	R23	R21	Standard

Keying & Cylinder Options		Specify	Price Add
Keyed different, AR keyway		ARKD	Standard
Keyed different, CS keyway		CSKD	No add
Lock prepared to accept a 6- or 7-pin SFIC cylinder (not included)		IC	No add

Parts	Part No.	Price
Standard cylinder with tailpiece – AR keyway	700HD	\$25.75
Standard cylinder with tailpiece – CS keyway	700HD-CS	\$25.75
Strike	306	\$26.71
Latch - 2-3/4" backset	R23 ¹ or R21 ²	\$15.59
Latch - 2-3/8" backset latch x 1" front (sold only as separate part)	R22 ¹ or R20 ²	\$15.59
Screw pack for latch & strike	RLX-201	\$1.89
Screw pack for chassis, rose, & thru-bolts	RLX-201A	\$1.89
IC tailpiece kit (tailpiece & spacer for 6- & 7-pin cores)	RLX-44-201	\$5.03

¹ Used only with non-keyed functions

² Used only with keyed functions

DBX Series

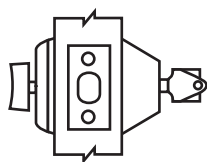

DBX61

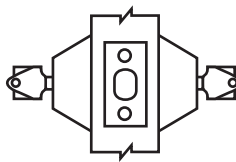

DBX62

Features

Certification	BHMA A156.36 Auxiliary Locks, Grade 2, UL Listed
Door Thickness	Fits 1-3/8" - 1-3/4", factory set for 1-3/4"
Strike	2-3/4" x 1-1/8", square corners
Latch	2-3/8" - 2-3/4", adjustable backset, 1" front, includes spacer for 1-1/8" door prep
Cylinder	6-pin, solid brass, keyed alike in 4, CS keyway includes 2 brass keys
Handing	Non-handed
Case Quantity	12
Average Case Weight	DBX61 - 18lbs. / DBX62 - 22lbs.
Warranty	1 year

Available Finishes	Arrow Code	BHMA Code	U.S. Code
Bright Brass	605	605	US3
Dark Oxidized Satin Bronze, equivalent	613E	613E	US10BE
Satin Stainless Steel	630	630	US32D

How to Order

Function	DBX61
Finish	DBX61-630
Keying	DBX61-630-CS-KA4

Function	Description	630	605, 613E
DBX61	Cylinder x Thumbturn	\$43.00	\$51.00
DBX62	Cylinder x Cylinder	\$61.00	\$69.00

DBX Series Options & Parts

Options

Strike Option	Specify	Price Add
2-3/4" x 1-1/8", square corners	394	Standard

Latch Option	Specify	Price Add
2-3/8" - 2-3/4", adjustable backset	L14	Standard

Keying & Cylinder Options	Specify	Price Add
CS keyway, keyed alike in 4	CS-KA4	Standard
AR keyway, keyed alike in 4	AR-KA4	No Add
Lock prepared to accept a 6- or 7-pin SFIC cylinder (not included)	IC	\$20.00

Parts

Parts	Part No.	Price Add
Cylinder for DBX61 x CS keyway, keyed different	96C-CS-DBX	\$20.01
Cylinder for DBX61 x AR keyway, keyed different	96C-DBX	\$20.01
Cylinder for DBX62 x CS keyway, keyed different	96DC-CS-DBX	\$20.01
Cylinder for DBX62 x AR keyway, keyed different	96DC-DBX	\$20.01
Strike	DBX-394	\$6.58
Standard bolt	DBX-L14	\$14.27
Optional drive in bolt (sold only as a separate part)	DBX-L18	\$14.27
Screw pack for DBX61	DBX61-201	\$8.48
Screw pack for DBX62	DBX62-201	\$8.48
Thick door pack for DBX61, up to 2" thick doors	DBX61-TDP	\$8.48
Thick door pack for DBX62, up to 2" thick doors	DBX62-TDP	\$8.48

D Series

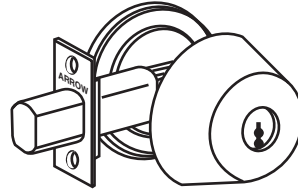

Features

Certification	BHMA A156.5, Grade 1, UL Listed
Door Thickness	Fits 1-3/8" - 1-3/4", factory set for 1-3/4"
Strike	Standard: 1-1/8" x 2-1/4"; alternate strikes available
Latch	Standard: 2-3/4" backset, 1-1/8" front; alternate bolts available
Cylinder	Standard: 6-pin, solid brass, 2 nickel-silver keys; IC prep available
Handing	Non-handed
Case Quantity	12
Average Case Weight	22 lbs.
Warranty	1 year

Available Finishes	Arrow Code	BHMA Code	U.S. Code
Bright Brass	03	605	US3
Satin Brass	04	606	US4
Black Suede Powder	BSP	-	-
Antique Brass	05A	609	US5
Satin Bronze	10	612	US10
Dark Oxidized Satin Bronze, Oil Rubbed	10B	613	US10B
Dark Oxidized Satin Bronze, equivalent	10BE	613E	US10BE
Bright Chromium Plated	26	625	US26
Satin Chromium Plated	26D	626	US26D

How to Order

Function	D61
Finish	D61-26D
Strike	D61-26D-346
Latch	D61-26D-346-144
Keying	D61-26D-346-144-KD-AR

Function	ANSI	Description	03, 26D	04, 05A, 10, 10B, 10BE, 26, BSP
D60	E01111	Thumbturn x Blank Plate	\$94.00	\$104.00
D61	E0151	Cylinder x Thumbturn	\$108.00	\$118.00
D62	E0141	Double Cylinder	\$141.00	\$151.00
D63	E0161	Cylinder x Blank Plate	\$113.00	\$123.00
D64	E0171	Cylinder x Thumbturn (classroom)	\$113.00	\$123.00
D71-IC ¹	E0151	Cylinder x Thumbturn	\$146.00	\$156.00
D73-IC ¹	E0161	Cylinder x Blank Plate	\$146.00	\$156.00
D74-IC ¹	E0171	Cylinder x Thumbturn (classroom)	\$146.00	\$156.00

¹Concealed mounting screws standard on D71 & D73 functions.

E Series

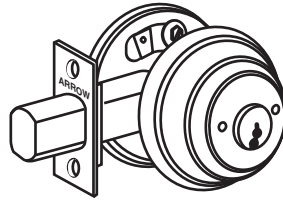

Features

Certification	BHMA A156.5, Grade 2, UL Listed
Door Thickness	Fits 1-3/8" - 1-3/4", factory set for 1-3/4"
Strike	Standard: 1-1/8" x 2-1/4"; alternate strikes available
Latch	Standard: 2-3/8" backset, 1-1/8" front; alternate bolts available
Cylinder	Standard: 6-pin, keyed 5, solid brass, 2 brass keys; IC prep available
Handing	Non-handed
Case Quantity	12
Average Case Weight	E61 - 20 lbs. / E62 - 25 lbs.
Warranty	1 year

Available Finishes	Arrow Code	BHMA Code	U.S. Code
Bright Brass	03	605	US3
Satin Brass	04	606	US4
Black Suede Powder	BSP	-	-
Antique Brass	05A	609	US5
Satin Bronze	10	612	US10
Dark Oxidized Satin Bronze, Oil Rubbed	10B	613	US10B
Dark Oxidized Satin Bronze, equivalent	10BE	613E	US10BE
Satin Nickel	15	619	US15
Bright Chromium Plated	26	625	US26
Satin Chromium Plated	26D	626	US26D

How to Order

Function	E61
Finish	E61-26D
Strike	E61-26D-346
Latch	E61-26D-346-141
Keying	E61-26D-346-141-KD-AR

Function	ANSI	Description	03, 26D	04, 05A, 10, 10B, 10BE, 15, 26, BSP
E50	-	Occupancy Indicator	\$58.00	\$68.00
E60	E01112	Thumbturn x Blank Plate	\$50.00	\$60.00
E61	E0152	Cylinder x Thumbturn	\$61.00	\$71.00
E62	E0142	Double Cylinder	\$76.00	\$86.00
E63	E0162	Cylinder x Blank Plate	\$68.00	\$78.00
E64	E0172	Cylinder x Thumbturn (classroom)	\$68.00	\$78.00
E71-IC ¹	E0152	Cylinder x Thumbturn	\$86.00	\$96.00
E74-IC ¹	E0172	Cylinder x Thumbturn (classroom)	\$93.00	\$103.00
E41 Low Profile ²	-	Cylinder x Thumbturn	\$58.00	\$68.00
E42 Low Profile ²	-	Double Cylinder	\$73.00	\$83.00

¹ Furnished with concealed mounting screws.

² Only available in 03, 26D, and 15 finishes.

D & E Series Options



345



346



347



350

Strike Options	Description	Specify	Price Add
Square Corner	345 & 346 strikes	395	Standard
Square Corner	1-1/8" x 2-3/4", for wood jambs (4 mounting holes)	345	No Add
Square Corner	1-1/8" x 2-3/4", for metal jambs (2 mounting holes)	346	No Add
ANSI	1-1/4" x 4-7/8", 1-1/4" lip, square corner	347	No Add
T-Strike	1-1/8" x 2-3/4", 1-1/4" lip, square corner	350	No Add

Bolt Options	Description	Specify >>>	Spring Latch	Dead Latch	Price Add
2-3/4" Backset	1-1/8", square corner			144	Standard (D Series)
2-3/8" Backset	1", square corner			141	Standard (E Series)
2-3/4" Backset	1", square corner			142	No Add
2-3/8" Backset	Drive-in			145	No Add
2-3/4" Backset	Drive-in			146	No Add
Less Latch				LAT	-\$6.10

Keying & Cylinder Options	Specify	Price Add
Keyed different	KD	Standard (D Series)
Keyed alike in four (quantity permitting)	KA4	Standard (E Series)
Master keyed ¹	MK	\$13.00 per cylinder
Construction master keyed ¹	CMK	\$8.16 per cylinder
Master keyed & construction master keyed ¹	MK-CMK	\$21.16 per cylinder
O-Bitted ¹	OB	No Add
Less Cylinder ¹	LC	-\$8.55
Lock prepared to accept 6 or 7-pin IC cylinder, less core	IC	\$25.00

¹ Not available with E41 or E42 function.

D & E Series Parts

Strikes	Description	Specify Finish	Part No.	Price
Square Corner	1-1/8" x 2-3/4", for metal jambs (4 mounting holes)	•	345	\$8.48
Square Corner	1-1/8" x 2-3/4", for wood jambs (2 mounting holes)	•	346	\$8.48
ANSI	1-1/4" x 4-7/8"	•	347	\$16.73
T-Strike	1-1/8" x 2-3/4", 1-1/4" lip	•	350	\$8.48
Box strike for E Series			BX91	\$2.73
Box strike for D Series			BX91D	\$2.73

Bolts	Description	Specify Finish	Part No.	Price
2-3/4"	1-1/8", square corner	•	144	\$18.36
2-3/8"	1", square corner	•	141	\$18.36
2-3/4"	1", square corner	•	142	\$18.36
2-3/8"	Drive-in	•	145	\$18.36
2-3/4"	Drive-in	•	146	\$18.36

Cylinder & Related	Specify Finish	Part No.	Price
Standard cylinder for E61, E63, E64	•	96C ¹	\$25.75
Standard cylinder for E62	•	96DC	\$25.75
Standard cylinder for E41	•	100	\$25.75
Standard cylinder for E42	•	100DC	\$25.75
Standard cylinder for D61, D63, D64	•	692C	\$25.75
Standard cylinder for D62	•	692DC	\$25.75
Single cylinder tailpiece, 1-3/8" to 1-3/4" thick door		D61-44	\$2.60
E42 tailpiece for 1-3/4" thick door		D62-44J	\$2.60
E42 tailpiece for 1-3/8" thick door		D62CR-44	\$2.60
Double cylinder tailpiece, 1-3/4" thick door		D62-44	\$2.60
Double cylinder tailpiece, 1-3/8" thick door		D62-44-13/8	\$2.60
E60/D60 Function tailpiece		E60-44	\$2.60
Cam assembly for 6 & 7-pin IC cylinders		D61CR-121A	\$5.03

¹ When ordered separately, can be installed on E41 for use on 1-3/4" thick door installation.

Parts & Accessories	Specify Finish	Part No.	Price
E50 Screwpack		E50-201	\$8.48
E60 Screwpack		E60-201	\$8.48
D60 Screwpack		D60-201	\$8.48
E61 Screwpack	•	E61-201	\$8.48
D61 Screwpack	•	D61-201	\$8.48
E62/D62 Screwpack	•	DE62-201	\$8.48
E61 Thick door pack, up to 2-1/4"	•	E61-TDP	\$8.48
D61 Thick door pack, up to 2-1/4"	•	D61-TDP	\$8.48
E62/D62 Thick door pack, up to 2-1/4"	•	E62-TDP	\$8.48

N Series

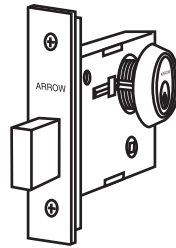

Features

Certification	UL Listed
Door Thickness	Fits 1-3/8" - 1-3/4"
Strike	Standard: 1-1/8" x 3-1/2"; alternate strikes available
Bolt	1" throw with hardened pin
Backset	2-3/4"
Cylinder	Standard: 6-pin, solid brass, 2 nickel-silver keys; IC prep available
Handing	Non-handed
Case Quantity	20
Average Case Weight	38 lbs.
Warranty	1 year

Auxiliary Locks

Available Finishes	Arrow Code	BHMA Code	U.S. Code
Bright Brass	03	605	US3
Satin Brass	04	606	US4
Satin Bronze	10	612	US10
Dark Oxidized Satin Bronze, Oil Rubbed	10B	613	US10B
Dark Oxidized Satin Bronze, equivalent	10BE	613E	US10BE
Bright Chromium Plated	26	625	US26
Satin Chromium Plated	26D	626	US26D

How to Order

Function	N41
Finish	N41-26D
Strike	N41-26D-380
Keying	N41-26D-380-KD-AR

Function	ANSI	Description	26D	03, 04, 10, 10B, 10BE, 26
N40	-	Thumbturn One Side	\$207.00	\$214.00
N41	E06071	Cylinder x Thumbturn	\$238.00	\$245.00
N42	E06061	Double Cylinder	\$247.00	\$254.00
N43	E06081	Cylinder One Side	\$216.00	\$223.00
N44	E06091	Cylinder x Thumbturn (classroom)	\$242.00	\$249.00

N Series Options & Parts



380



356

Strike Options	Description	Specify	Price Add
Square Corner	1-1/8" x 3-1/2"	380	Standard
ANSI	1-1/4" x 4-7/8"	356	\$8.25

Keying & Cylinder Options	Specify	Price Add
Keyed different	KD	Standard
Master keyed	MK	\$13.00 per cylinder
Construction master keyed	CMK	\$8.16 per cylinder
Master keyed & construction master keyed	MK-CMK	\$21.16 per cylinder
O-Bitted	OB	No Add
Less Cylinder	LC	-\$13.35
Lock prepared to accept 6-pin SFIC cylinder, less core	IC6	No Add
Lock prepared to accept 7-pin SFIC cylinder, less core	IC7	No Add



836-17A

Parts	Specify Finish	Part No.	Price
Standard mortise cylinder	•	MC61-004	\$40.12
Square corner strike, 1-1/8" x 3-1/2"	•	380	\$8.48
ANSI strike, 1-1/4" x 4-7/8"	•	356	\$16.73
Thumbturn	•	836-17A	\$22.93
Faceplate & screw pack	•	836-204	\$19.67
Lock body only		836K-LB	\$156.00

Padlocks

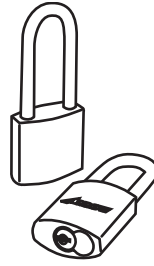

SFIC Padlocks (cylinder not included)

Shackle	Part No.	Price
1"	EPC1-IC	\$70.00
2"	EPC2-IC	\$72.00
3"	EPC3-IC	\$73.00



K Bow



L Bow

Keys & Keying Charges Standard Cylinders

Key Blanks	Part No.	Price
Standard bow, 5-pin key blank, "A" keyway	K5A	\$1.29
Standard bow, 6-pin key blank, "A" keyway	K6A	\$1.29
Large bow, 6-pin key blank, "A" keyway	L6A	\$2.08
Sectional keyway, standard bow, 6-pin	K671 x (kwy ¹)	\$2.08
Sectional keyway, large bow, 6-pin	L671 x (kwy ¹)	\$2.08

¹ Consult factory for Arrow sectional keyways.

Cut Keys	Price
Extra cut keys	\$4.33 per key
Master or Grandmaster key	\$8.74
Construction master key	\$8.74

Keying Charges	Price
Master keyed	\$13.00 per cylinder
Construction master keyed	\$8.16 per cylinder
Keyed different	No Add
Keyed alike	No Add
0-Bitted	No Add

Key Stamping	Price
Stamping key with letters and/or numbers (limited to key space)	\$4.68 per side
Stamping key with <i>US Property Do Not Duplicate</i>	\$1.69 per side
Stamping non-IC key ² with <i>Do Not Duplicate</i>	\$1.69 per side

Key Control for factory-master-keyed systems	Specify	Price
Stamping cylinder (visual) and 2 keys with standard keying symbols	VKC	\$4.68 per set
Stamping cylinder (concealed) and 2 keys with standard keying symbols	CKC	\$4.68 per set
Stamping each additional key with standard keying symbols		\$3.13 per key

² Coining on IC keys include: *Duplication Prohibited* or *It Is Unlawful To Duplicate This Key*.

Bitting list only or bitting list copy	Bitting List	\$105.00
<ul style="list-style-type: none"> • Bitting lists are provided on disks. Systems not available on disk will be provided on paper. • Large key systems on paper will be priced on a case-by-case basis. • Copies of bitting lists may require prior factory approval. 		

Cylinders Mortise & Rim

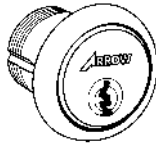

Mortise Cylinder

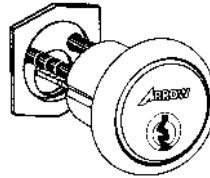

Rim Cylinder

Mortise Cylinders ¹	Specify Finish	Part No.	Price
Standard 1-1/8" cylinder	•	MC61-(cam)	\$40.12
1-1/4" Cylinder	•	MC61-2-(cam)	\$40.12
1-1/2" Cylinder	•	MC61-3-(cam)	\$59.25
2" Cylinder	•	MC61-4-(cam)	\$59.25

¹ Standard 001 cam supplied unless otherwise specified.

Mortise Cylinder Parts	Specify Finish	Part No.	Price
Cam for mortise lock functions 12, 17, 22, 23, 24, 27, 32 (I/S), 33, 37		001	\$3.47
Cam for mortise lock functions 11, 13, 19, 20, 21, 31, 32 (O/S), 34, 38, 40, 41, 42, 44		AM2	\$3.47
Cam for N series, panic device trims, alarms		004	\$3.47
Cam for Schlage locks		006	\$3.47
Cam for Adam Rite locks		AR18	\$3.47
Cylinder collar and spring	•	16-113A	\$9.24

Rim Cylinders	Specify Finish	Part No.	Price
Standard 6-pin cylinder	•	RC62	\$40.12

Rim Cylinder Parts	Part No.	Price
Cam bar for RC62	16RC-44	\$2.60
Plug/cam bar retainer	16RC-103	\$1.24



ASSA ABLOY

November 1, 2018

Conventional Cylinders Cylindrical Locks & Deadbolts

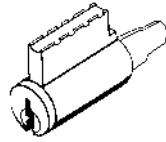

Cylindrical Lock Cylinder

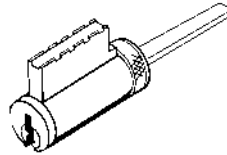

Deadbolt Cylinder

Cylindrical Lock Cylinders	Specify Finish	Part No.	Price
MK Series (except hotel function)	•	100C	\$25.75
MK Series hotel function	•	H100C	\$40.12
Cylinder kit (D/B style cyl w/3 D/B cambars, 3 KIK/KIL tail pcs, D/B washer)	•	K100C	\$30.39

Tailpiece Application	Part No.	Price
Q, W, H, S, ML, L & RL Series (except hotel function)	1001-44	\$2.60
Q, W, H, & ML Series hotel function	1001H-44	\$2.60
MK Series with TA or DD trim (except hotel function)	550AM-44	\$2.60
MK Series with BD trim (except hotel function), and RK Series	750-44	\$2.60
MK Series hotel function with TA or DD trim	550H-44	\$2.60
MK Series hotel function with BD trim	750H-44	\$2.60

Deadbolt Cylinders	Specify Finish	Part No.	Price
E Series single cylinder	•	96C	\$25.75
E Series double cylinder	•	96DC	\$25.75
D Series single cylinder	•	692C	\$25.75
D Series double cylinder	•	692DC	\$25.75

Tailpiece Application	Part No.	Price
D & E Series single cylinder, 1-3/8" to 1-3/4" thick door	D61-44	\$2.60
D & E Series double cylinder, 1-3/4" thick door	D62-44	\$2.60
D & E Series double cylinder, 1-3/8" thick door	D62-44-13/8	\$2.60

Available Keyways	Arrow Equivalent
Arrow A	AR
Schlage C	CS

Keys & Cylinders

IC Housings

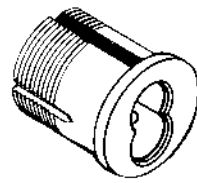

Mortise IC Housing

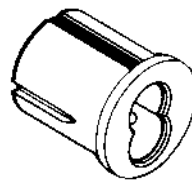

Rim IC Housing

Mortise Housings ¹		Specify Finish	Part No.	Price
6-pin housings, 1-1/8"	Standard	•	16CR-16X (cam)	\$39.34
	Tapered	•	16CRT-16XAR18	\$40.85
7-pin housings, 1-1/4"	Standard	•	16CR-27X (cam)	\$39.34
	Tapered	•	16CRT-27XAR18	\$40.85

¹ Standard 16CR-001 cam supplied unless otherwise specified.

Mortise Housing Parts	Specify Finish	Part No.	Price
Cam for mortise lock functions 12, 17, 22, 23, 24, 27, 32 (I/S), 33, 37		16CR-001	\$3.47
Cam for mortise lock functions 11, 13, 19, 20, 21, 31, 32 (O/S), 34, 38, 40, 41, 42, 44		16CR-AM2	\$3.47
Cam for N series, panic device trims, alarms		16CR-004	\$3.47
Cam for Schlage locks		16CR-006	\$3.47
Cam for Adams Rite locks		16CR-AR18	\$3.47
1/8" Spacer ring	•	16CR-123-1	\$13.47
1/4" Spacer ring	•	16CR-123-2	\$13.47
3/8" Spacer ring	•	16CR-123-3	\$13.47

Rim Housings	Specify Finish	Part No.	Price
6-pin housing	•	16RCR-16	\$39.34
7-pin housing	•	16RCR-27	\$39.34

Rim Housing Parts	Part No.	Price
Cam bar	16RCR-44	\$2.60
Cam assembly (equal leg prongs)	16RCR-121A	\$8.48
Spring washer	16RCR-125	\$0.78
Yoke plate	961CR-117	\$0.96
Pan head screw (2 required)	4-40X1/4	\$0.44

• See *Plus Housings* section for Plus-related components.

Pointe SFIC Cylinders



SFIC Cylinders with Standard Barrel Caps		Part No.	04, 26D
6-pin core	Uncombined	100CR-UCX (kwy)	\$20.38
	Combined ¹	100CR- (kwy)	\$38.54
7-pin core	Uncombined	7100CR-UCX (kwy)	\$20.38
	Combined ¹	7100CR- (kwy)	\$38.54

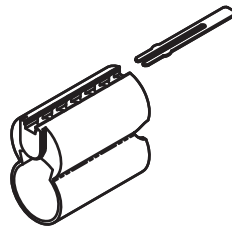

SFIC Cylinders with Slide Cover		Part No.	04, 26D
6-pin core	Uncombined	100SR-UCX (kwy)	\$22.47
	Combined ¹	100SR- (kwy)	\$42.02
7-pin core	Uncombined	7100SR-UCX (kwy)	\$22.47
	Combined ¹	7100SR- (kwy)	\$42.02

¹ Combined cores includes 2 operating keys and related keying charges.

Keys

For Keyways: 1C, 1D, AB, BB, CB, DB, EB, FB, GB, HB, JB, KB, LB, MB, QB, RB, TA, TB, TC, TD, TE	Part No.	Price
Key blank	C(kwy)	\$1.29
Operating key		\$4.33
Control key		\$8.74

For Keyways: WA, WB, WC, WG, WH, WY	Part No.	Price
Key blank	GB(kwy)	\$3.22
Operating key		\$9.68
Control key		\$9.68

Stamping Charges	Price
Stamping key with letters and/or numbers (limited to key space)	\$4.68 per side
Stamping key with <i>US Property Do Not Duplicate</i>	\$1.69 per side
Stamping cylinder with standard keying symbols (specify visual or concealed)	\$3.13

Stamping Charges for factory systems	Specify	Price
Stamping cylinder (visual) and 2 keys with standard keying symbols	VKC	No Add
Stamping cylinder (concealed) and 2 keys with standard keying symbols	CKC	No Add
Stamping each additional key with standard keying symbols		\$3.13 per key

Construction Cores & Tailpieces

Construction Cores & Components	Part No.	04, 26D
6-pin construction core	100CR.RED	\$20.38
7-pin construction core	7100CR.RED	\$20.38
Disposable SFIC plug adapter	13-5176	\$0.88
Construction master key		\$8.74
Construction control key		\$8.74

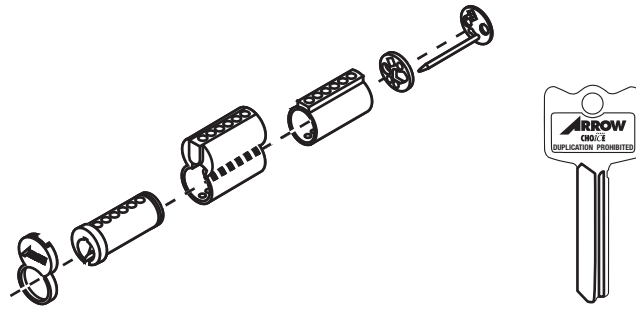

Pointe Flex SFIC Cylinders Patented Product

Pointe Flex SFIC Cylinders & Keys ¹		Part No.	04, 26D
6-pin core	Uncombined	X1CR-UCX (kwy)	\$31.08
	Combined	X1CR-(kwy)	\$50.25
7-pin core	Uncombined	X71CR-UCX (kwy)	\$31.08
	Combined	X71CR-(kwy)	\$50.25
Key blank without hole		CH (kwy)	\$1.29
Key blank with hole		CHX (kwy)	\$4.33
Operating key without hole			\$5.29
Operating key with hole			\$8.74
Master, grandmaster, or control key			\$8.74

¹ See Pointe SFIC page for stamping charges.
 • Contact factory for Flex keyway information.

Tailpieces & Components	Application	Part No.	Price
IC core tailpiece pack for 6- & 7-pin cores	RL Series 6-pin IC core tailpiece	HSCR6-44	\$3.10
	RL Series 7-pin IC core tailpiece	HSCR7-44	\$3.10
	MK Series	550CR-44-201	\$5.03
	RK Series	100CR-44-201	\$5.03
Tailpiece for use with Falcon...	6-pin core levers	X1CRF6-44	\$2.58
	7-pin core levers	X71CRF7-44	\$2.58
Tailpiece for use with Best...	6-pin core levers or knobs	X1CRB6-44	\$2.58
	7-pin core levers or knobs	X71CRB7-44	\$2.58
Tailpiece insert for cylindrical locks – 100-piece pack		X1CR-125PK	\$8.39

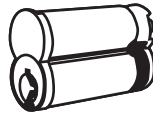

Sliding Door Lock	Part No.	04, 26D
7-Pin uncombined	SD7100CR-UCX (kwy)	\$45.90
7-Pin combined	SD7100CR- (kwy)	\$58.55

Cam Locks

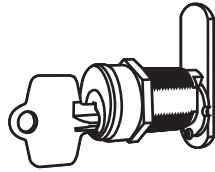

Cam Lock Kits	Part No.	Price
Sub-Assembled	CLK-10-(kwy ¹).26D	\$58.30
Keyed different or keyed alike w/2 cut keys (not master-keyed)	CLK-11-(kwy ¹).26D	\$73.85
Master-keyed w/2 cut keys	CLK-11M-(kwy ¹).26D	\$86.60

¹ Available with standard Arrow IC keyways except for W and Flex.

Cam Lock Parts	Part No.	Price
Machined Plug	IKMPLG-(kwy).26D	\$11.90
Shell	IKSHELL2.26D	\$19.50
4-40 Screw	IKSCRPLT	\$0.95
Retainer	CP-021810	\$0.38
90° Stop	IKSTOP2	\$2.81
3/4" Hex Nut	IKHXNUT	\$0.35
Drive Pin	IKDRPIN	\$1.61
360° Drive Plate (NKR)	IKDRPLT	\$2.86
90° Drive Plate (KR)	IKDRPLT2	\$4.36
Cam, Straight	IKCAM2	\$3.15
Cam, Offset	IKCAM3	\$6.93
Pronged Washer	IKWSH1	\$0.79
Tumbler Spring	IKTSPRING ²	\$5.25
Pin Hole Cover	IKPNCVR ²	\$10.50

² Unit price shown. Sold in package quantities of 100.

Cam Lock Accessories	Part No.	Price
Spacer, 1/16"	IKSPCR1.26D	\$4.60
Spacer, 1/8"	IKSPCR3.26D	\$5.30
Spacer, 3/16"	IKSPCR4.26D	\$5.61
Spacer, 1/4" (provided with cam lock kit)	IKSPCR5.26D	\$5.74
Spacer, 5/16"	IKSPCR2.26D	\$5.80
Spacer, 3/8"	IKSPCR6.26D	\$6.49
Spacer, 7/16"	IKSPCR7.26D	\$6.79

Plus IC Housings

Mortise Housings for Plus Cores ^{1,2}		Specify Finish	Part No.	Price
6-pin housings, 1-1/8"	Standard	•	C16CR-16X (cam)	\$39.34
	Tapered	•	C16CRT-16XAR18	\$40.85
7-pin housings, 1-1/4"	Standard	•	C16CR-27X (cam)	\$39.34
	Tapered	•	C16CRT-27XAR18	\$40.85

Mortise Housing Parts	Specify Finish	Part No.	Price
Cam for mortise lock functions 12, 17, 22, 23, 24, 27, 32 (I/S), 33, 37		001	\$3.47
Cam for mortise lock functions 11, 13, 19, 20, 21, 31, 32 (O/S), 34, 38, 40, 41, 42, 44		AM2	\$3.47
Cam for N series, panic device trims, alarms		004	\$3.47
Cam for Schlage locks		006	\$3.47
Cam for Adam Rite locks		AR18	\$3.47
Cam assembly (unequal leg prongs) for 7-pin mortise housing		C16CR-121A	\$8.48
Cam assembly (unequal leg prongs) for 6-pin mortise housing		C16CR-121A-1	\$8.48

Rim Housings for Plus Cores ¹	Specify Finish	Part No.	Price
6-pin housing	•	C16RCR-16	\$39.34
7-pin housing	•	C16RCR-27	\$39.34

Rim Housing Parts	Part No.	Price
Cam bar	16RCR-44	\$2.60
Cam assembly (unequal leg prongs) for 7-pin rim housing	C16RCR-121A	\$8.48
Cam assembly (unequal leg prongs) for 6-pin rim housing	C16RCR-121A-1	\$8.48
Spring washer	16RCR-125	\$0.78
Yoke plate	961CR-117	\$0.96
Pan head screw (2 required)	4-40X1/4	\$0.44

Tools & Components	Application	Part No.	Price
IC Housing shear tool		IC281	\$186.00
MK Series IC core tailpiece pack for 6- & 7-pin cores		CM-44-201	\$5.03
RK Series 6-pin IC core tailpiece		CH6-44	\$3.10
RK Series 7-pin IC core tailpiece		CH7-44	\$3.10
RL Series 6-pin IC core tailpiece		CL6-44	\$3.10
RL Series 7-pin IC core tailpiece		CL7-44	\$3.10

¹ Unequal leg prongs.

² Screw-on cams. Standard 001 cam supplied unless otherwise specified.

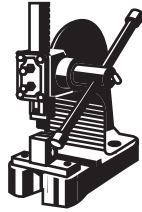

IC220 Capping Press

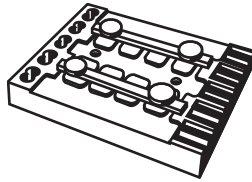

IC233 Stamping Tray

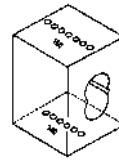

IC234 Duo Block

Cylinder Parts & Tools

IC Tools	Part No.	Price
1/2 Ton capping press	IC220	\$1,550.00
Mortise cylinder installation tool	IC230	\$50.00
Cam assembly tool for 16CR-xxx housings	IC231	\$99.00
Stamping tray	IC233	\$1,643.00
Duo block (for capping)	IC234	\$232.00
Ejector pin (single ejector)	IC235	\$35.00
50 Capping strips (200 cores)	IC237	\$66.00
Best style punch machine (A2 system)	IC240	\$6,186.00
Flex vise for key punch machine	IC240A	\$1,009.00

Keying Kits & Components

For conventional cylinders	Part No.	Price	
Keying kit - pins, springs, slides, retainer rings, plug followers, tail pieces	60-Key-Kit	\$228.00	
	Top pins	AD142PK	\$8.01
Replacement pins	Bottom pins	AB140PK to 149PK	\$8.01
Note: Bulk packed 100 pcs per pack	Master pins	AM142PK to 149PK	\$8.01
	Cylinder caps (strips)	60C-111PK	\$8.01

For IC cylinders	Part No.	Price	
Keying kit - pins, springs, cap gauge, pin ejector, capping pin	IC200	\$666.00	
	Bottom pins	RB100PK to 109PK	\$8.85
Replacement pins & caps	Top pins	RM102PK to 119PK	\$8.85
Note: Bulk packed 100 pcs per pack	Springs	100CR-107PK	\$8.85
	Barrel caps	100CR-111PK	\$8.85
Key gauge	IC205	\$6.77	
Pin ejector	IC206	\$64.00	
Replacement pin for IC206	IC206-1	\$10.48	
Capping tool	IC207	\$300.00	
Capping pin	IC208	\$61.00	
	For 6-pin cores	100CR-130 ¹	\$48.30
Slide cap cover	For 7-pin cores	7100CR-130 ¹	\$48.30

¹ Unit price shown. Sold in package quantities of 100.

Architectural Panic Devices

Features	
Certification	BHMA A156.3, Grade 1, available UL Listed
Door Thickness	1-3/4"
Cylinder (where applicable)	Standard: 6-pin, solid brass, 2 nickel-silver keys; IC prep available
Handing	Right-hand Reverse (RR) or Left-hand Reverse (LR)
Warranty	5 years

Available Finishes	Arrow Code	BHMA Code	U.S. Code
Bright brass	03	605	US3
Satin brass	04	606	US4
Satin bronze	10	612	US10
Dark oxidized satin bronze, oil rubbed	10B	613	US10B
Dark oxidized satin bronze, equivalent	10BE	613E	US10BE
Bright chromium plated	26	625	US26
Satin chromium plated	26D	626	US26D
Bright stainless steel	32	629	US32
Satin stainless steel	32D	630	US32D
Aluminum painted or powder coated	AL	689	-

How to Order	
Series	38
Function	38-88
Exterior Trim & Finish (optional)	38-88-SL-26D
Door Width ¹	38-88-SL-26D-F
Interior Finish (pushbar)	38-88-SL-26D-F-32D
Handing	38-88-SL-26D-F-32D-RR

¹ F indicates a 36" wide door; E indicates a 24" door; G indicates a 48" door.

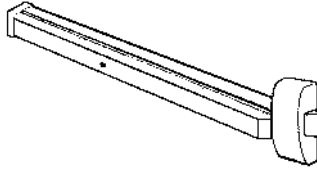

3880 Series Rim Panic Device

Less Trim	Part No.	AL ¹	10, 10B, 10BE, 32D	03, 04, 32
Exit only	38-81			
Classroom function	Less SL lever trim	38-88		
	Less pull trim	38-05		
Storeroom function	Less trim	38-83	\$1,132.00	\$1,257.00
Passage function	Less SL lever trim	38-8A		
	Less pull trim	38-5A		\$1,312.00

Panic Device With Trim

	SL ² Lever Trim	10, 10B, 10BE, 32D	03, 04, 26, 32
Classroom	38-88-SL	\$1,724.00	\$1,804.00
Storeroom	38-83-SL	\$1,724.00	\$1,804.00
Passage	38-8A-SL	\$1,684.00	\$1,764.00
Dummy Trim	38-82-SL	\$1,684.00	\$1,764.00
	SS Pull Trim	10, 10B, 10BE, 32D	03, 04, 26, 32
Classroom	38-05-SS	\$1,583.00	\$1,663.00
Storeroom	38-83-SS	\$1,583.00	\$1,663.00
Passage	38-5A-SS	\$1,543.00	\$1,623.00
Dummy Trim	38-82-SS	\$1,543.00	\$1,623.00
	SN ² Pull Trim	10, 10B, 10BE, 32D	03, 04, 26, 32
Classroom	38-05-SN	\$1,542.00	\$1,622.00
Storeroom	38-83-SN	\$1,542.00	\$1,622.00
Passage	38-5A-SN	\$1,502.00	\$1,582.00
Dummy Trim	38-82-SN	\$1,502.00	\$1,582.00
	SB Pull Trim	10, 10B, 10BE, 32D	03, 04, 26, 32
Classroom	38-05-SB	\$1,542.00	\$1,622.00
Storeroom	38-83-SB	\$1,542.00	\$1,622.00
Passage	38-5A-SB	\$1,502.00	\$1,582.00
Dummy Trim	38-82-SB	\$1,502.00	\$1,582.00
	SP Pull Trim	10, 10B, 10BE, 32D	03, 04, 26, 32
Classroom	38-05-SP	\$1,542.00	\$1,622.00
Storeroom	38-83-SP	\$1,542.00	\$1,622.00
Passage	38-5A-SP	\$1,502.00	\$1,582.00
Dummy Trim	38-82-SP	\$1,502.00	\$1,582.00

Trim Only

	SL ² Lever Trim	10, 10B, 10BE, 26D	03, 04, 26
	SL88	\$467.00	\$492.00
	SL83	\$467.00	\$492.00
	SL88A	\$427.00	\$452.00
	SL02	\$427.00	\$452.00
	SS Pull Trim	10, 10B, 10BE, 26D, 32D	03, 04, 26, 32
	SS05	\$326.00	\$351.00
	SS83	\$326.00	\$351.00
	SS05A	\$286.00	\$311.00
	SS02	\$286.00	\$311.00
	SN ² Pull Trim	10, 10B, 10BE, 26D	03, 04, 26
	SN05	\$285.00	\$310.00
	SN83	\$285.00	\$310.00
	SN05A	\$245.00	\$270.00
	SN02	\$245.00	\$270.00
	SB Pull Trim	10, 10B, 10BE, 26D, 32D	03, 04, 26, 32
	SB05	\$285.00	\$310.00
	SB83	\$285.00	\$310.00
	SB05A	\$245.00	\$270.00
	SB02	\$245.00	\$270.00
	SP Pull Trim	10, 10B, 10BE, 26D, 32D	03, 04, 26, 32
	SP05	\$285.00	\$310.00
	SP83	\$285.00	\$310.00
	SP05A	\$245.00	\$270.00
	SP02	\$245.00	\$270.00

¹ AL finish applies to pushrail.

² SL and SN trims are not available in 32D or 32 finish; 26D or 26 supplied.

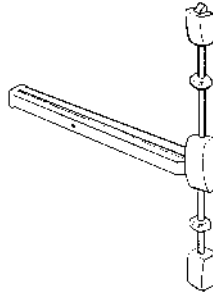

3700 Series Surface Vertical Rod Panic Device

Less Trim	Part No.	AL ¹	10, 10B, 10BE, 32D	03, 04, 32
Exit only	37-01			
Classroom function	Less SL trim	37-08		
	Less pull trim	37-05	\$1,699.00	\$1,831.00
Passage function	Less SL trim	37-8A		
	Less pull trim	37-5A		\$1,886.00

Panic Device With Trim

	SL ² Lever Trim	10, 10B, 10BE, 32D	03, 04, 26, 32
Classroom	37-08-SL	\$2,298.00	\$2,378.00
Passage	37-8A-SL	\$2,258.00	\$2,338.00
Dummy Trim	37-02-SL	\$2,258.00	\$2,338.00
	SS Pull Trim	10, 10B, 10BE, 32D	03, 04, 26, 32
Classroom	37-05-SS	\$2,157.00	\$2,237.00
Passage	37-5A-SS	\$2,117.00	\$2,197.00
Dummy Trim	37-02-SS	\$2,117.00	\$2,197.00
	SN ² Pull Trim	10, 10B, 10BE, 32D	03, 04, 26, 32
Classroom	37-05-SN	\$2,116.00	\$2,196.00
Passage	37-5A-SN	\$2,076.00	\$2,156.00
Dummy Trim	37-02-SN	\$2,076.00	\$2,156.00
	SB Pull Trim	10, 10B, 10BE, 32D	03, 04, 26, 32
Classroom	37-05-SB	\$2,116.00	\$2,196.00
Passage	37-5A-SB	\$2,076.00	\$2,156.00
Dummy Trim	37-02-SB	\$2,076.00	\$2,156.00
	SP Pull Trim	10, 10B, 10BE, 32D	03, 04, 26, 32
Classroom	37-05-SP	\$2,116.00	\$2,196.00
Passage	37-5A-SP	\$2,076.00	\$2,156.00
Dummy Trim	37-02-SP	\$2,076.00	\$2,156.00
	Aux. Control	10, 10B, 10BE, 32D	03, 04, 26, 32
Classroom	37-11-S3	\$2,184.00	\$2,264.00
Storeroom	37-12-S3	\$2,184.00	\$2,264.00

Trim Only

	SL ² Lever Trim	10, 10B, 10BE, 26D	03, 04, 26
	SL08	\$467.00	\$492.00
	SL08A	\$427.00	\$452.00
	SL02	\$427.00	\$452.00
	SS Pull Trim	10, 10B, 10BE, 26D, 32D	03, 04, 26, 32
	SS05	\$326.00	\$351.00
	SS05A	\$286.00	\$311.00
	SS02	\$286.00	\$311.00
	SN ² Pull Trim	10, 10B, 10BE, 26D	03, 04, 26
	SN05	\$285.00	\$310.00
	SN05A	\$245.00	\$270.00
	SN02	\$245.00	\$270.00
	SB Pull Trim	10, 10B, 10BE, 26D, 32D	03, 04, 26, 32
	SB05	\$285.00	\$310.00
	SB05A	\$245.00	\$270.00
	SB02	\$245.00	\$270.00
	SP Pull Trim	10, 10B, 10BE, 26D, 32D	03, 04, 26, 32
	SP05	\$285.00	\$310.00
	SP05A	\$245.00	\$270.00
	SP02	\$245.00	\$270.00
	Aux. Control	10, 10B, 10BE, 26D, 32D	03, 04, 26, 32
	S311	\$353.00	\$378.00
	S312	\$353.00	\$378.00

¹ AL finish applies to pushrail.

² SL and SN trims are not available in 32D or 32 finish; 26D or 26 supplied.

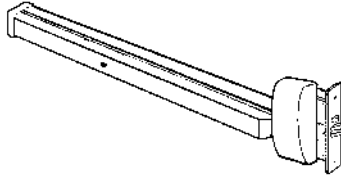

3900 Series Mortise Panic Device

Less Trim	Part No.	AL ¹	10, 10B, 10BE, 32D	03, 04, 32
Exit only	39-01			
Classroom function	Less SL lever trim	39-08		
	Less pull trim	39-05		
Storeroom function	Less trim	39-03	\$1,600.00	\$1,775.00
Passage function	Less SL lever trim	39-8A		
	Less pull trim	39-5A		\$1,830.00

Panic Device With Trim

	SL ² Lever Trim	10, 10B, 10BE, 32D	03, 04, 26, 32
Classroom	39-08-SL	\$2,242.00	\$2,322.00
Storeroom	39-03-SL	\$2,242.00	\$2,322.00
Passage	39-8A-SL	\$2,202.00	\$2,282.00
Dummy Trim	39-02-SL	\$2,202.00	\$2,282.00
	SS Pull Trim	10, 10B, 10BE, 32D	03, 04, 26, 32
Classroom	39-05-SS	\$2,101.00	\$2,181.00
Storeroom	39-03-SS	\$2,101.00	\$2,181.00
Passage	39-5A-SS	\$2,061.00	\$2,141.00
Dummy Trim	39-02-SS	\$2,061.00	\$2,141.00
	SN ² Pull Trim	10, 10B, 10BE, 32D	03, 04, 26, 32
Classroom	39-05-SN	\$2,060.00	\$2,140.00
Storeroom	39-03-SN	\$2,060.00	\$2,140.00
Passage	39-5A-SN	\$2,020.00	\$2,100.00
Dummy Trim	39-02-SN	\$2,020.00	\$2,100.00
	SB Pull Trim	10, 10B, 10BE, 32D	03, 04, 26, 32
Classroom	39-05-SB	\$2,060.00	\$2,140.00
Storeroom	39-03-SB	\$2,060.00	\$2,140.00
Passage	39-5A-SB	\$2,020.00	\$2,100.00
Dummy Trim	39-02-SB	\$2,020.00	\$2,100.00
	SP Pull Trim	10, 10B, 10BE, 32D	03, 04, 26, 32
Classroom	39-05-SP	\$2,060.00	\$2,140.00
Storeroom	39-03-SP	\$2,060.00	\$2,140.00
Passage	39-5A-SP	\$2,020.00	\$2,100.00
Dummy Trim	39-02-SP	\$2,020.00	\$2,100.00

Trim Only

	SL ² Lever Trim	10, 10B, 10BE, 26D	03, 04, 26
	SL08	\$467.00	\$492.00
	SL03	\$467.00	\$492.00
	SL08A	\$427.00	\$452.00
	SL02	\$427.00	\$452.00
	SS Pull Trim	10, 10B, 10BE, 26D, 32D	03, 04, 26, 32
	SS05	\$326.00	\$351.00
	SS03	\$326.00	\$351.00
	SS05A	\$286.00	\$311.00
	SS02	\$286.00	\$311.00
	SN ² Pull Trim	10, 10B, 10BE, 26D	03, 04, 26
	SN05	\$285.00	\$310.00
	SN03	\$285.00	\$310.00
	SN05A	\$245.00	\$270.00
	SN02	\$245.00	\$270.00
	SB Pull Trim	10, 10B, 10BE, 26D, 32D	03, 04, 26, 32
	SB05	\$285.00	\$310.00
	SB03	\$285.00	\$310.00
	SB05A	\$245.00	\$270.00
	SB02	\$245.00	\$270.00
	SP Pull Trim	10, 10B, 10BE, 26D, 32D	03, 04, 26, 32
	SP05	\$285.00	\$310.00
	SP03	\$285.00	\$310.00
	SP05A	\$245.00	\$270.00
	SP02	\$245.00	\$270.00

¹ AL finish applies to pushrail.

² SL and SN trims are not available in 32D or 32 finish; 26D or 26 supplied.

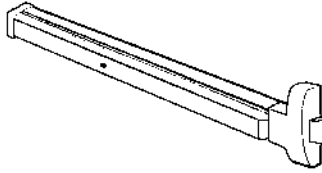

4800 Series Narrow Stile Rim Panic Device

Less Trim		Part No.	10, 10B, 10BE, 32D	03, 04, 32
Exit only		48-01		
Classroom function	Less SL lever trim	48-08	\$1,431.00	\$1,486.00
Storeroom function	Less trim	48-03		
Passage function	Less SL lever trim	48-8A		

Panic Device With Trim			
	SL ¹ Lever Trim	10, 10B, 10BE, 32D	03, 04, 26, 32
Classroom	48-08-SL	\$1,898.00	\$1,978.00
Storeroom	48-03-SL	\$1,898.00	\$1,978.00
Passage	48-8A-SL	\$1,858.00	\$1,938.00
Dummy Trim	48-02-SL	\$1,858.00	\$1,938.00
	SS Pull Trim	10, 10B, 10BE, 32D	03, 04, 26, 32
Storeroom	48-03-SS	\$1,757.00	\$1,837.00
Dummy Trim	48-02-SS	\$1,717.00	\$1,797.00
	SN ¹ Pull Trim	10, 10B, 10BE, 32D	03, 04, 26, 32
Storeroom	48-03-SN	\$1,716.00	\$1,796.00
Dummy Trim	48-02-SN	\$1,676.00	\$1,756.00

Trim Only			
	SL ¹ Lever Trim	10, 10B, 10BE, 26D	03, 04, 26
	SL08	\$467.00	\$492.00
	SL03	\$467.00	\$492.00
	SL08A	\$427.00	\$452.00
	SL02	\$427.00	\$452.00
	SS Pull Trim	10, 10B, 10BE, 26D, 32D	03, 04, 26, 32
	SS03	\$326.00	\$351.00
	SS02	\$286.00	\$311.00
	SN ¹ Pull Trim	10, 10B, 10BE, 26D	03, 04, 26
	SN03	\$285.00	\$310.00
	SN02	\$245.00	\$270.00

¹ SL and SN trims are not available in 32D or 32 finish; 26D or 26 supplied.

- Not available fire-rated.

4900 Series Narrow Stile Mortise Panic Device

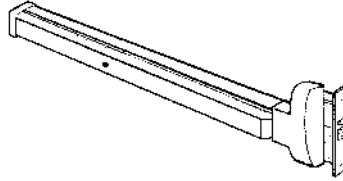

Less Trim	Part No.	10, 10B, 10BE, 32D	03, 04, 32
Exit only	49-01		
Classroom function	Less SL lever trim	49-08	
Storeroom function	Less trim	49-03	\$1,612.00
Passage function	Less SL lever trim	49-8A	\$1,667.00

Panic Device With Trim

	SL ¹ Lever Trim	10, 10B, 10BE, 32D	03, 04, 26, 32
Classroom	49-08-SL	\$2,079.00	\$2,159.00
Storeroom	49-03-SL	\$2,079.00	\$2,159.00
Passage	49-8A-SL	\$2,039.00	\$2,119.00
Dummy Trim	49-02-SL	\$2,039.00	\$2,119.00
	SS Pull Trim	10, 10B, 10BE, 32D	03, 04, 26, 32
Storeroom	49-03-SS	\$1,938.00	\$2,018.00
Dummy Trim	49-02-SS	\$1,898.00	\$1,978.00
	SN ¹ Pull Trim	10, 10B, 10BE, 32D	03, 04, 26, 32
Storeroom	49-03-SN	\$1,897.00	\$1,977.00
Dummy Trim	49-02-SN	\$1,857.00	\$1,937.00

Trim Only

	SL ¹ Lever Trim	10, 10B, 10BE, 26D	03, 04, 26
	SL08	\$467.00	\$492.00
	SL03	\$467.00	\$492.00
	SL08A	\$427.00	\$452.00
	SL02	\$427.00	\$452.00
	SS Pull Trim	10, 10B, 10BE, 26D, 32D	03, 04, 26, 32
	SS03	\$326.00	\$351.00
	SS02	\$286.00	\$311.00
	SN ¹ Pull Trim	10, 10B, 10BE, 26D	03, 04, 26
	SN03	\$285.00	\$310.00
	SN02	\$245.00	\$270.00

¹ SL and SN trims are not available in 32D or 32 finish; 26D or 26 supplied.

Architectural Panic Device Options

Architectural Panic Device Options	Specify	Price	
Rail Size	For 24" to 32" door widths	E	No Add
	For 32-1/4" to 36" door widths	F	Standard
	For 36-1/4" to 48" door widths	G	No Add
Handing	Right-hand reverse	RR	n/a
	Left-hand reverse	LR	n/a
UL Fire label (except 3700 & 4800 Series)	FR	\$175.00	
UL Fire label for 3700 Series ¹	FR	\$198.00	
Cylinder dogging (includes cylinder) (not available with UL fire label devices)	CD	\$83.25	
3700 Series less bottom rod	LBR ²	No Add	
Fire-rated 3700 Series less bottom rod	LBR ²	\$67.30	
Sliding bottom bolt for 3700 Series	SB ³	No Add	
Vandal-proof lever	VP ²	\$299.00	
Knurled outside lever	103 ²	\$82.30	

Keying & Cylinder Options (when ordering trim)	Specify	Price
Keyed different	KD	Standard
Master keyed	MK	\$13.00 per cylinder
Construction master keyed	CMK	\$8.16 per cylinder
Master keyed & construction master keyed	MK-CMK	\$21.16 per cylinder
O-Bitted	OB	No Add
Less cylinder	LC	-\$13.35
Exit trim prepared to accept 6 or 7-pin SFIC cylinder, less core	IC	No Add

¹ Includes thru-bolts.

² Used only with SL trim.

³ Cannot be combined with FR option.

Architectural Panic Device Electrification Options

Architectural Panic Device Electrification Option	Voltage	Specify	Price Add ¹
Fail-safe trim control without key override ²	12V AC/DC	177	\$807.00
	24V AC/DC	179	\$807.00
Fail-secure trim control without key override ²	12V AC/DC	181	\$807.00
	24V AC/DC	183	\$807.00
Fail-safe trim control with key override ³	12V AC/DC	185	\$979.00
	24V AC/DC	186	\$979.00
Fail-secure trim control with key override ³	12V AC/DC	187	\$979.00
	24V AC/DC	188	\$979.00
Latchbolt monitoring ⁵		LM	\$273.00
Request to exit - authorized ⁶		RE	\$273.00
Electric latch retraction ^{4,6}		E6	\$1,064.00
Signal switch ^{6,7}		E7	\$393.00
Electric dogging ⁶		E8	\$841.00

Power Supplies	Part No.	Price
Electric latch retraction for up to two doors	1406	\$664.00

¹ Electrification charges do not include price of panics.

² SL trim only; not available with 3900 or 4900 Series.

³ SL trim only; not available with 3700 or 4800 Series.

⁴ Cannot be combined with options: CD, LM, RE, and E7; not available in rail size E.

⁵ Not available with 4800 Series.

⁶ Not available with 488A or 4808.

⁷ Not available with 3800 Series, 3701, 3702, 375A, 3711, 3712, 488A, 4808.

- **Fail-Safe Trim Control**

Power on locks outside lever. Inside lever always free. For options 185, 186, 187, and 188, latch retracted by key when locked electronically.

- **Fail-Secure Trim Control**

Power off locks outside lever. Inside lever always free. For options 185, 186, 187, and 188, latch retracted by key when locked electronically.

- **Latchbolt Monitoring**

Full extension of the latch monitored by a SPDT switch.

- **Request to Exit — Authorized Egress**

Inside trim monitored by an SPDT switch. Switch can be used to shunt a door alarm to allow egress, signal a control console when the trim is activated, or activate a door alarm.

- **Electric Latch Retraction**

Provides a remote means of unlocking exit devices by momentary or maintained latch retraction.

- **Signal Switch**

Consists of two SPDT switches that monitor the touch bar and main latch. This feature also allows for alarm shunt via a mortise cylinder (not included) located on the tail of the exit device

- **Electric Dogging**

Simultaneously provides continuous latch retraction and dogging. When energized, first time mechanical activation of the push bar will continuously hold the latch retracted. When power is removed or interrupted, the latch bolt will extend and the push bar released.

S1150, S1250, ED910, & PEC910 Series Panic Devices

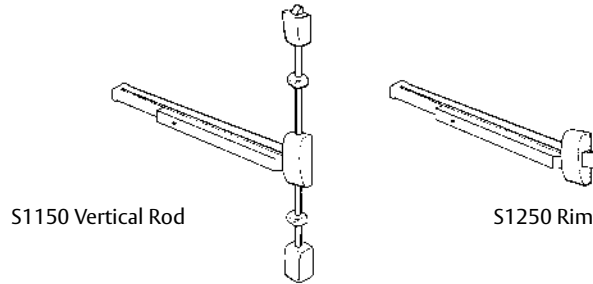

S1150/S1250 Devices Less Trim

Standard Panic Devices for 32-1/4" to 36" Door Widths	AL, BRZ, LBZ	Price
Surface vertical rod	S1150	\$701.00
Rim	S1250	\$367.00

Fire-Rated Panic Devices for 32-1/4" to 36" Door Widths	AL, BRZ, LBZ	Price
Surface vertical rod	FS1150	\$888.00
Rim	FS1250	\$532.00

Panic Device Options	Add Suffix	Price Add
Cylinder dogging	CD	\$83.25
Cylinder dogging prepared to accept 6- or 7-pin SFIC cylinder (not included)	CDIC	\$83.25
For 24" to 32" door widths	24	No Add
For 36-1/4" to 48" door widths	48	No Add

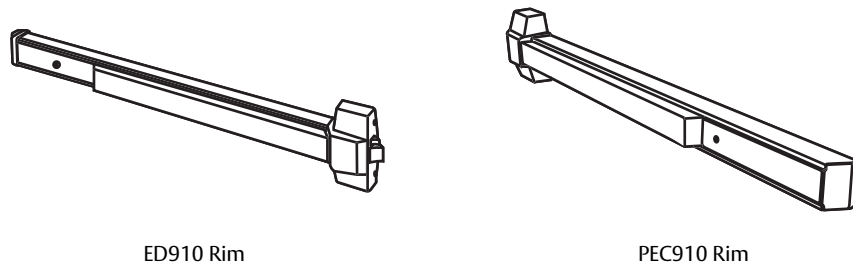

ED910/PEC910 Panic Devices

ED910 Rim Panic Device	Part No.	689, 613E	630
For 31" to 36" door widths	ED910-36	\$234.00	\$319.00
For 43" to 48" door widths	ED910-48	\$234.00	\$319.00

PEC910 Permanent End Cap Rim Panic Device	Part No.	689, 613E	630
For 31" to 36" door widths	PEC910-36	\$284.00	\$368.00

Parts	Part No.	689, 613E	630
Strike	ES90	\$23.48	-
Screw pack	ES9-201	\$12.54	-
End cap	ES9CAP	\$21.15	\$21.15
Installation Template	ES9TMPLT-36	\$105.00	-



ASSA ABLOY

November 1, 2018

S1150, S1250, ED910, & PEC910 Series Exit Trim

Trims

Lever Trim		613E, 26D	Price
Passage		SRX01	\$111.00
Storeroom	Standard cylinder	SRX82	\$111.00
	SFIC prep, less core	SRX82-IC	\$111.00
Classroom	Standard cylinder	SRX87	\$111.00
	SFIC prep, less core	SRX87-IC	\$111.00
Knob Trim		03, 04, 10, 10B, 26D	Price
Passage		BD01 or TA01	\$143.00
Storeroom	Standard cylinder	BD12 or TA12	\$157.00
	SFIC prep, less core	TA12-IC	\$182.00
Classroom	Standard cylinder	BD17 or TA17	\$157.00
	SFIC prep, less core	TA17-IC	\$182.00
Plate Trim		AL, BRZ, LBZ	Price
Blank Plate		SF01	\$63.00
Dummy Pull		SF02	\$69.00
Storeroom	Standard cylinder	SF12	\$113.00
	SFIC prep, less core	SF12-IC	\$113.00

Panic Device Accessories

Accessories		Part No.	Price
Shim kit for 3880 or 3900 Series		S59	\$88.95
Shim kit for 3700 Series		S57	\$107.00
Shim kit for S1150		SH64	\$124.00
Shim kit for S1250		SH65	\$101.00
18" Extension rod kit for 3700 or S1150 Series		VRX-18	\$101.00
Dummy push rail for 3000 & 4000 Series (specify plated finish)	For 24" to 32" door widths	S3000-24	\$385.00
	For 32-1/4" to 36" door widths	S3000-36	\$385.00
	For 36-1/4" to 48" door widths	S3000-48	\$385.00
Dummy push rail for 3000 & 4000 Series (specify sprayed finish)	For 24" to 32" door widths	S3000-24	\$308.00
	For 32-1/4" to 36" door widths	S3000-36	\$308.00
	For 36-1/4" to 48" door widths	S3000-48	\$308.00

Thru-Bolts

Series	Description	Part No.	Price
3880	Standard & fire-rated	FS54	\$19.51
3700	Standard	S53	\$56.75
	UL fire-rated	FS53	\$64.80
3900	Standard & fire-rated	FS54	\$19.51
4800	Standard	FS65	\$19.51
4900	Standard & fire-rated	FS65	\$19.51
S1150	Standard	S51	\$56.75
	UL fire-rated	FS51	\$64.80
S1250	Standard & fire-rated	FS52	\$19.51

Panic Device Mullions

Mullions	Part No.	Price
Removable mullion - 96"	S20	\$449.00
Removable mullion - 120"	S20-120	\$522.00
Key removable mullion - 96", less cylinder	S20-K	\$987.00
Key removable mullion - 120", less cylinder	S20L-K	\$1,034.00
Removable mullion for narrow stile - 96"	S20-N	\$964.00
Removable mullion for narrow stile - 120"	S20-N-120	\$1,121.00
Fire-rated removable mullion - 96"	S21	\$602.00
Fire-rated key removable mullion - 96", less cylinder	S21-K	\$1,125.00
Top Retainer for S20	S10	\$50.20
Bottom retainer for S20	S11A	\$50.20
Top retainer for S20-N	S91	\$85.80
Bottom retainer for S20-N	S92	\$85.80
Stabilizer for S20-N	S90	\$50.20
Top retainer for S21	S88	\$85.80
Bottom retainer for S21	S89	\$85.80
Mortise cylinder for key removable mullion	MC61-004	\$40.12
IC housing for key removable mullion	16CR-27X004	\$39.34

Panic Device Parts

Parts	Part No.	Price	
SL08 spindle adapter (converts trim to SL88)	SL-386A	\$30.75	
SL08 spindle adapter (required when using trim with 4800 Series)	SLS-386A	\$42.16	
SL trim cover plate (covers stock hollow metal cut-out)	38-88A	\$154.00	
Mortise lockbody for 3900 or 4900 Series	Storeroom function	SL93	\$363.00
	Classroom function for thumb pull trim	SL95	\$363.00
	Passage function for thumb pull trim	SL95A	\$363.00
	Classroom function for SL trim	SL98	\$363.00
	Passage function for SL trim	SL98A	\$363.00
End cap for 3000 & 4000 Series	32-7027	\$21.15	
End cap mounting bracket for 3000 & 4000 Series	68-2141	\$21.15	
End cap for S1150 & S1250 Series	28-0112	\$21.15	
End cap mounting bracket for S1150 & S1250 Series	68-0080	\$21.15	
Dogging kit	68-2596	\$21.15	
Dogging key	97-0001	\$9.81	

Standard Rail Assembly	Standard	Fire-Rated	Price	
Plated finish rail assembly for 3000 Series	For 24" to 32" door widths	R-24	RF-24	\$401.00
	For 32-1/4" to 36" door widths	R-36	RF-36	\$401.00
	For 36-1/4" to 48" door widths	R-48	RF-48	\$401.00
Sprayed finish rail assembly for 3000 Series	For 24" to 32" door widths	R-24	RF-24	\$322.00
	For 32-1/4" to 36" door widths	R-36	RF-36	\$322.00
	For 36-1/4" to 48" door widths	R-48	RF-48	\$322.00
Sprayed finish rail assembly for S1150 & S1250 Series	For 24" to 32" door widths	PR-24	PRF-24	\$264.00
	For 32-1/4" to 36" door widths	PR-36	PRF-36	\$264.00
	For 36-1/4" to 48" door widths	PR-48	PRF-48	\$264.00

Rail Assembly with Cylinder Dogging	Part No.	Price	
Plated finish rail assembly for 3000 Series with cylinder dogging	For 24" to 32" door widths	RCD-24	\$484.25
	For 32-1/4" to 36" door widths	RCD-36	\$484.25
	For 36-1/4" to 48" door widths	RCD-48	\$484.25
Sprayed finish rail assembly for 3000 Series with cylinder dogging	For 24" to 32" door widths	RCD-24	\$405.25
	For 32-1/4" to 36" door widths	RCD-36	\$405.25
	For 36-1/4" to 48" door widths	RCD-48	\$405.25
Sprayed finish rail assembly for S1150 & S1250 Series with cylinder dogging	For 24" to 32" door widths	PR-24CD	\$347.25
	For 32-1/4" to 36" door widths	PR-36CD	\$347.25
	For 36-1/4" to 48" door widths	PR-48CD	\$347.25

Panic Device Strikes

Strikes

Series	Description	Part No.	Price
3880	Standard & fire rated	S38	\$44.30
	Double door	S36	\$44.30
3700	Standard & fire-rated	S646	\$48.79
	Standard bottom	S23	\$48.79
	UL fire-rated bottom	S43	\$48.79
3900	Standard	S48C	\$28.99
	Open back	S47	\$44.30
4800	Standard	S38	\$44.30
	Double door	S36	\$44.30
	Flush	S56	\$44.30
4900	Standard	S48C	\$28.99
	Open back	S47	\$44.30
S1150	Standard & fire-rated	S646	\$48.79
	Standard bottom	S23	\$48.79
	UL fire-rated bottom	S43	\$48.79
S1250	Standard & fire rated	S38	\$44.30
	Double door	S36	\$44.30

7700 Series Door Operator

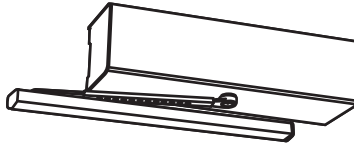

Powered Door Operator

Hinge (Pull) Side of Door	Part No.	AL, DBZ
Standard unit	7710	\$1,576.00
Standard unit with (1) 7710SW5 wall switch	7710K1	\$1,773.00
Standard unit with power cord	7710P	\$1,595.00
Standard unit with power cord & (1) 7710SW5 wall switch	7710PK1	\$1,792.00
Radio frequency unit	7710RF1	\$1,688.00
Radio frequency unit with (1) 7800T1 transmitter	7710EX	\$1,805.00
Radio frequency unit with power cord	7710PRF1	\$1,707.00
Radio frequency unit with power cord & (1) 7800T1 transmitter	7710PEX	\$1,824.00

Stop (Push) Side of Door	Part No.	AL, DBZ
Standard unit	7730	\$1,576.00
Standard unit with (1) 7710SW5 wall switch	7730K1	\$1,773.00
Standard unit with power cord	7730P	\$1,595.00
Standard unit with power cord & (1) 7710SW5 wall switch	7730PK1	\$1,792.00
Radio frequency unit	7730RF1	\$1,688.00
Radio frequency unit with (1) 7800T1 transmitter	7730EX	\$1,805.00
Radio frequency unit with power cord	7730PRF1	\$1,707.00
Radio frequency unit with power cord & (1) 7800T1 transmitter	7730PEX	\$1,824.00

Parts & Accessories	Part No.	Price
Door Switch - 6" sq., Stainless/Blue Letters, ADA Symbol, Radio Frequency	7800SW2	\$236.00
Door Switch - 6" sq., Stainless/Blue Letters, ADA Symbol, Hard Wired	7800SW3	\$144.00
Door Switch - 6" sq., Stainless/Blue Letters, Radio Frequency	7800SW1	\$236.00
Door Switch - 6" sq., Stainless/Blue Letters, Hard Wired	7800SW4	\$144.00
Touchless Wall Switch	7710SW5	\$384.00
Radio Frequency (RF1) Kit	7710RK	\$121.00
Power Cord	7710PC	\$19.00
Inverter	7710IN	\$648.00
Cover	7710COV	\$86.00
Motor and Main Arm Assembly	7710M	\$974.00
Motor, Main Arm and Tube Assembly	7730M	\$974.00
Power Supply	7710PS	\$92.00
Motor Assembly	7800MA	\$898.00
Screw Pack	7710SP	\$22.00

7800/7900 Series
Door Operator

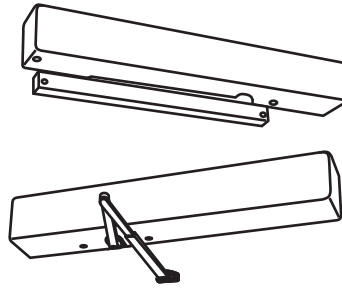

7800 Series Power Door Operators – Sizes 1-6

Mount Application	Radio Frequency	2 Wall Switches	Part No.	AL, DBZ
Hinge/Pull			7836H	\$2,895.00
	✓		7836HR	\$3,007.00
	✓	✓	7836HRP	\$3,479.00
Stop/Push			7836S	\$2,895.00
	✓		7836SR	\$3,007.00
	✓	✓	7836SRP	\$3,479.00
Universal			7836U	\$2,927.00
	✓		7836UR	\$3,039.00

7900 Series Power Door Operators (Power Cord Version) – Sizes 1-6

Mount Application	Radio Frequency	2 Wall Switches	Part No.	AL, DBZ
Hinge/Pull			7936H	\$2,914.00
	✓		7936HR	\$3,026.00
	✓	✓	7936HRP	\$3,498.00
Stop/Push			7936S	\$2,914.00
	✓		7936SR	\$3,026.00
	✓	✓	7936SRP	\$3,498.00
Universal			7936U	\$2,946.00
	✓		7936UR	\$3,058.00



ASSA ABLOY

November 1, 2018

7800/7900 Series Parts

Parts/Accessories	Part No.	Price
Chain	7800CH	\$18.00
Motor Assembly	7800MA	\$898.00
Inverter	7800IN	\$548.00
On/Off Switch	7800PS	\$5.10
Pillow Block (Aluminum Backplate)	7800PB	\$68.00
Pinion Extension/Clutch Assembly (Aluminum Backplate)	7800CA	\$219.00
Door Position Adjustment Assembly	7800AA	\$84.00
Cover	7800CO	\$86.00
Arm & Track Assembly (Pull)	7800TC	\$258.00
Arm Assembly	7800TA	\$91.00
Track Assembly	7800TO	\$181.00
Arm Assembly (Push)	7800SC	\$86.00
Main Arm & Rod	7800SA	\$77.00
Adjusting Tube & Shoe	7800ST	\$33.00
Single Channel Hand Held Transmitter	7800T1	\$103.00
Double Channel Hand Held Transmitter	7800T2	\$130.00
Reed Switch	7800RS	\$18.00
RF Power Supply	7800PWS	\$92.00
Operational Signs	7800SK9	\$37.00
Signage Kit 1	7800SK1	\$6.00
Signage Kit 2	7800SK2	\$6.00
Closer Body	914BO	\$160.00

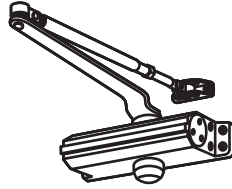

DC300 Series Door Closer

DC300 Surface Applied Door Closers	Part No.	Price
Size 1-4, std NHO arm, PA bracket	DC314	\$148.00
Size 1-4, std HO arm, PA bracket	DC314-1	\$174.00
Size 2-5, std NHO arm, PA bracket	DC325	\$148.00
Size 2-5, std HO arm, PA bracket	DC325-1	\$174.00

Parts & Accessories	Part No.	Price
Full plastic cover, screw pack, 1-3/8" thru-bolts	DC3CVR	\$24.16
Thru-bolts 2"	DC500TB2	\$6.15

- Packed 6 per case.
- Specify AL or DBZ finish.

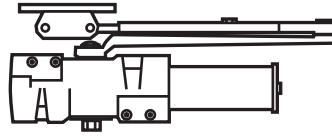

DC500 Series Door Closer

Features

Certification	ANSI A156.4 and ANSI ICC A117.1 Grade 1
Size	1 to 6
Cover	Included: full plastic
Thru-Bolts	Included: 1-3/4"
Case Quantity	4
Average Case Weight	51.4 lbs.
Warranty	10 years

Description	Part No.	Price
Standard arm, non-hold open, with PA bracket	DC516	\$233.00
Standard arm, hold open, with PA bracket	DC516-1	\$283.00
Heavy-duty dead stop arm, non-hold open	DC516-2	\$281.00
Heavy-duty dead stop arm, hold open	DC516-3	\$310.00

Parts & Accessories	Part No.	Price
Full Plastic Cover	DC500CV	\$22.80
Drop Plate - Regular	DC500DP	\$22.12
Drop Plate - Parallel Arm	DC500DP1	\$24.40
Drop Plate - Top Jamb, Flush Ceiling	DC500DP3	\$22.12
Drop Plate - Top Jamb	DC500DP2	\$22.12
Thru-bolts 1-3/4"	DC500TB1	\$6.15
Thru-bolts 1-3/8"	DC500TB3	\$6.15
Thru-bolts 2-1/4"	DC500TB2	\$6.15
Standard Screw Pack	DC500SP2	\$9.83
Standard Non-Hold Open Arm	DC500A	\$79.85
Standard Hold Open Arm	DC500A1	\$91.65
Heavy-Duty Dead Stop Arm Non-Hold Open	DC500A2	\$96.05
Heavy-Duty Dead Stop Arm Hold Open	DC500A3	\$108.00
Heavy-Duty Cushion Arm Non-Hold Open	DC500A4	\$125.00
Heavy-Duty Cushion Arm Hold Open	DC500A5	\$141.00

- Specify AL or DBZ finish.

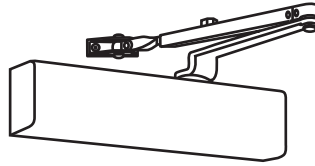

5016N Series Door Closer

Tri-pack Models – Sizes 1-6	Part No.	Price
Standard arm, slim plastic cover	5016NS	\$340.00
Standard arm, full plastic cover	5016N	\$346.00
Standard arm, slim plastic cover, delayed action	5016NSD	\$376.00
Standard arm, full plastic cover, delayed action	5016ND	\$382.00
Hold-open arm, slim plastic cover	5016NSH	\$376.00
Hold-open arm, full plastic cover	5016NH	\$382.00
Hold-open arm, slim plastic cover, delayed action	5016NSHD	\$412.00
Hold-open arm, full plastic cover, delayed action	5016NHD	\$418.00

Door Saver Parallel Arm Models – Sizes 1-6	Part No.	Price
Slim plastic cover	5016NPS	\$382.00
Full plastic cover	5016NP	\$392.00
Slim plastic cover, delayed action	5016NPSD	\$417.00
Full plastic cover, delayed action	5016NPD	\$424.00
Hold-open arm, slim plastic cover	5016NPSH	\$427.00
Hold-open arm, full plastic cover	5016NPH	\$434.00
Hold-open arm, slim plastic cover, delayed action	5016NPSHD	\$463.00
Hold-open arm, full plastic cover, delayed action	5016NPHD	\$469.00

Parts & Accessories	Part No.	Price
Drop plate	5016DP	\$45.42
Full plastic cover	5016FC	\$22.79
Slim plastic cover	5016SC	\$16.26
5016N Closer body	5016BO	\$243.00
5016N Closer body with delayed action	5016BOD	\$279.00
Thru-bolts for 1-3/8" thick doors	5016TB38	\$10.52
Thru-bolts for 1-3/4" thick doors	5016TB34	\$10.52
Thru-bolts for 2-1/4" thick doors	5016TB214	\$10.52
Complete (tri-pack) standard arm assembly	5016CNA	\$77.75
Complete (tri-pack) hold-open arm assembly	5016CHA	\$114.00
Door saver arm assembly, non-hold-open	5016CDNA	\$123.00
Door saver arm assembly, hold-open	5016CDHA	\$169.00

- Packed 4 per case. Average case weight 16 lbs.
- Specify AL, DBZ, LBZ, GL, or BLK finish.

Alarmed Hardware

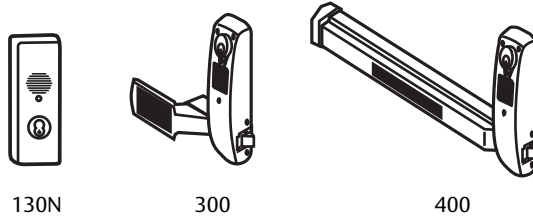

Alarmed Hardware	Part. No.	TAN	AL, BRZ, RD	10, 10B, 26, 26D
Stand alone	130N	\$346.00	-	-
Stand alone with remote mounting	130NXL	\$399.00	-	-
Paddle type	330 ²	-	\$762.00	\$847.00
Push bar type	430 ²	-	\$894.00	\$1,082.00
Fire-rated push bar type	F430 ²	-	\$1,039.00	\$1,227.00

Alarm Options ¹	Specify	Price Add
Remote monitor (wiring for remote monitor and power)	RM	\$55.00
Remote power (power supply not included)	RP	\$55.00
Continuous alarm	CA	\$55.00
Automatic rearming	AR	\$55.00

¹ Not available with 130N Series.

² Specify LR or RR handing.

- All units designed to accept outside cylinder operation. Supplied less cylinder.
- All units include low battery alert feature.
- 300 Series packed 8 per case.
- 130N packed 20 per case.
- 400 Series packed 1 per case.

Alarmed Hardware

Trim & Accessories

Trims

Lever Trim		613E, 26D	Price
Passage		SRX01	\$111.00
Storeroom	Standard cylinder	SRX82	\$111.00
	SFIC prep, less core	SRX82-IC	\$111.00
Classroom	Standard cylinder	SRX87	\$111.00
	SFIC prep, less core	SRX87-IC	\$111.00
Knob Trim		03, 04, 10, 10B, 26D	Price
Passage		BD01 or TA01	\$143.00
Storeroom	Standard cylinder	BD12 or TA12	\$157.00
	SFIC prep, less core	TA12-IC	\$182.00
Classroom	Standard cylinder	BD17 or TA17	\$157.00
	SFIC prep, less core	TA17-IC	\$182.00
Plate Trim		AL, BRZ, LBZ	Price
Blank Plate		SF01	\$63.00
Dummy Pull		SF02	\$69.00
Storeroom	Standard cylinder	SF03	\$118.00
	SFIC prep, less core	SF03-IC	\$118.00

Accessories

Strikes	Part No.	Price
For 300, 400, & F400 Series	S38	\$44.30
Optional double door strike	S36	\$44.30
Thru-Bolts	Part No.	Price
For 300 & 400 Series	S32	\$18.42
Narrow Stile Mounting Plates	Part No.	Price
For 300 Series	S74	\$122.00
For 400 Series	S75	\$139.00
Warning Signs & Labels	Part No.	Price
Adhesive label for 300 Series	32-1143	\$10.26
Adhesive label for 400 & F400 Series	32-1144	\$10.26

Alarmed Hardware Parts

300 & 400 Series	Part No.	Price
Roller/micro switch (red & yellow wires)	32-7044	\$87.45
On/off switch	32-7062	\$52.85
Circuit board (specify x20 or x30)	32-7070	\$287.00
Electronics & painted cover for x30	32-7035	\$486.00
Battery snap assembly	32-7043	\$6.02
Paddle & chassis for 300 Series	32-7065	\$226.00
Active chassis for 400 Series	32-7171	\$121.00
End cap mounting bracket for 400 Series	68-2141	\$21.15
End cap for 400 Series	32-7027	\$21.15
End cap for F400 Series	32-7080	\$21.15
Dogging key	97-0001	\$9.81
Paddle for 300 Series	32-1224	\$94.00

Discontinued Products

Arrow Revolution Yale Replacement Part Numbers

V1 Part Number (discontinued)	Replaced By Yale Part Number	Description
N/A	AUNTB610NR-626-100CV1-6	NXTOUCH-PB-AU-626-ARKD
N/A	AUNTB610NR-626-2803-53L-6	NXTOUCH-PB-AU-626-CSKD
N/A	AUNTB610NR-626-ICLC	NXTOUCH-PB-AU-626-IC
V151-SR-26D-V14-V44-AR-KD	AUNTB620NR-626-100CV1-6	NXTOUCH-TS-AU-626-ARKD
V151-SR-26D-V14-V44-CS-KD	AUNTB620NR-626-2803-53L-6	NXTOUCH-TS-AU-626-CSKD
V151-SR-26D-V14-V44-IC	AUNTB620NR-626-ICLC	NXTOUCH-TS-AU-626-IC
V2 Part Number (discontinued)	Replaced By Yale Part Number	Description
V251-10BP-V2S-V2L-CS-KD	YRD226NR-0BPSC	YRL-DB-TS-NR-US10BP-SC
V251-03-V2S-V2L-CS-KD	YRD226NR-605SC	YRL-DB-TS-NR-US3-SC
V251-15-V2S-V2L-CS-KD	YRD226NR-619SC	YRL-DB-TS-NR-US15-SC
V3 Part Number (discontinued)	Replaced By Yale Part Number	Description
V351-LR-10BP-V3S-V3L-CS-KD	YRL220NR-0BPSC	YRL-LL-TS-NR-US10BP-SC
V351-LR-03-V3S-V3L-CS-KD	YRL220NR-605SC	YRL-LL-TS-NR-US3-SC
V351-LR-15-V3S-V3L-CS-KD	YRL220NR-619SC	YRL-LL-TS-NR-US15-SC

CONTACT CUSTOMER SERVICE FOR ADDITIONAL INFORMATION.



V1 Series

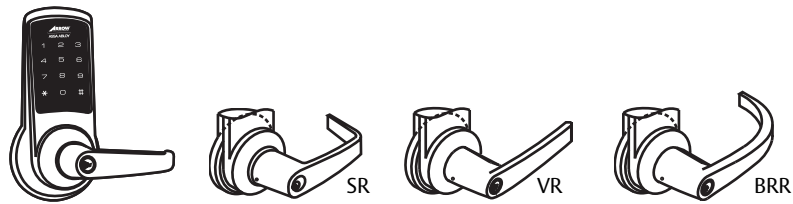

DISCONTINUED. LIMITED AVAILABILITY THROUGH DISTRIBUTION ONLY. CONTACT CUSTOMER SERVICE FOR ADDITIONAL INFORMATION.

Features

Certification	BHMA A156.2, Series 4000, Grade 1
Door Thickness	1-3/4", kit available for 1-3/8" thick doors
Strike	Standard: ANSI 1-1/4" x 4-7/8"; T-strike available
Latch	2-3/4" backset, 1-1/8" front
Cylinder	Standard: 6-pin, solid brass, 2 nickel-silver keys; IC prep available
Handing	Non-handed
Case Quantity	3
Average Case Weight	22 lbs.
Warranty	3 years

Available Finishes	Arrow Code	BHMA Code	U.S. Code
Bright Brass	03	605	US3
Dark Oxidized Satin Bronze, equivalent	10BE	613E	US10BE
Satin Chromium Plated	26D	626	US26D

How to Order

Function	V151
Trim	V151-SR
Finish	V151-SR-26D
Strike	V151-SR-26D-V14
Latch	V151-SR-26D-V14-V44
Keying	V151-SR-26D-V14-V44-KD-AR

Strike Options	Specify
ANSI	V14
T-Strike	V18
ANSI with box strike	V10

Latch Options	Specify
2-3/4" backset, 1-1/8" beveled front	V44
2-3/4" backset, 1-1/8" flat front	V45

Keying & Cylinder Options	Specify
Keyed different	KD
Less Cylinder	LC
O-Bitted	OB
Lock prepared to accept a 6- or 7-pin SFIC cylinder (not included)	IC
Lock prepared to accept an LFIC Medeco or ASSA cylinder (not included)	LIC ¹
Lock prepared to accept an LFIC Schlage cylinder (not included)	SIC ¹
Lock prepared to accept an LFIC Corbin Russwin cylinder (not included)	CIC ¹

¹ Available only with SR trim.

**DISCONTINUED. LIMITED AVAILABILITY THROUGH DISTRIBUTION ONLY.
CONTACT CUSTOMER SERVICE FOR ADDITIONAL INFORMATION.**

Strikes	Part No.
ANSI Strike, 1-1/4" lip	V14
T-Strike, 1-1/4" lip	V18
Box strike	V10
Latches	Part No.
2-3/4" Backset, 2-1/4" x 1-1/8" beveled front	V44
2-3/4" Backset, 2-1/4" x 1-1/8" flat front	V45
2-3/4" Backset, 2-1/4" x 1" front	V35 ¹
2-3/8" Backset, 2-1/4" x 1" front	V38 ¹
Cylinder & Related	Part No.
Standard AR cylinder with tailpiece	100C-V1
Alternate CS cylinder with tailpiece	100CS-V1
Standard keyblank	K6A
Tailpiece for standard cylinder	550V1-44
Parts & Accessories	Part No.
Inside SR lever - all functions	MS-01A-V1A
Outside SR lever - standard cylinder prep; less cylinder	MS-56A-V1
Outside escutcheon assembly (o/s escutcheon; touchscreen assembly)	V1-ESC-OS
Inside escutcheon assembly (i/s escutcheon, electronics, batteries, battery cover)	V1-ESC-IS
1-3/8" Thin door kit (includes I/S & O/S escutcheon spacers and a V38 ¹ latch)	V1-KIT1
Motorized lock chassis	V15X-LB
Battery cover	V1-BCOV
Weather gasket kit (inside & outside gasket replacements)	V1-GSK-PK
Remote unlock and power wire harness	V1-RMTE
5" Extension link (used only with V44 or V45 latches)	V25 x 5 ¹
Pro-Lok door prep template for the Arrow V1 Series	IN490
Pro-Lok universal clamp for holding door prep template	INCL
Trimplate pack (included 3 pairs with screws)	RP1
Display mount	MOUNT-V1
Lever return spring	14-5300-1021-999

¹ Sold only as a separate part. Not tested to grade 1 specifications. If substituted for standard latch, grade 1 rating is voided.



V251 Touchscreen

**DISCONTINUED. LIMITED AVAILABILITY THROUGH DISTRIBUTION ONLY.
CONTACT CUSTOMER SERVICE FOR ADDITIONAL INFORMATION.**

Features

Certification	BHMA A156.36, Grade 2
Door Thickness	Fits 1-3/8" to 2-1/4", factory set for 1-3/4" (gasket req. for 1-3/8" thick door)
Strike	1-1/8" x 2-3/4", round corners
Latch	2-3/8" - 2-3/4" adjustable backset, 1" front, round corners
Cylinder	Standard: 6-pin, solid brass, 2 brass keys; IC prep available
Handing	Non-handed
Case Quantity	5
Average Case Weight	11 lbs.

Available Finishes	Arrow Code	BHMA Code	U.S. Code
Bright Brass	03	605	US3
Dark Oxidized Satin Bronze, Clear Coated	10BP	614	US10BL
Satin Nickel	15	619	US15

How to Order

Function	V251
Finish	V251-15
Strike	V251-15-V2S
Latch	V251-15-V2S-V2L
Keying	V251-15-V2S-V2L-CS-KD

Options	Specify
Strike	V2S
Latch	V2L
Keyed Different	KD
V251 function prepared to accept 6- or 7-pin SFIC cylinder (not included)	IC

Parts & Accessories	Part No.
Strike	V2S
Latch	V2L
Drive-in latch ¹	V2LD
Standard CS cylinder with tailpiece	96CS-V2
Alternate AR cylinder with tailpiece	96C-V2
Tailpiece for standard cylinder	V2-44
Battery cover	V2-BCOV
V251 gasket for 1-3/8" thick door	V23-51-GSK
Display mount	MOUNT-V23

¹ Sold only as a separate part.



V351 Touchscreen

**DISCONTINUED. LIMITED AVAILABILITY THROUGH DISTRIBUTION ONLY.
CONTACT CUSTOMER SERVICE FOR ADDITIONAL INFORMATION.**

Features	
Certification	BHMA A156.36, Grade 2
Door Thickness	Fits 1-3/8" to 1-3/4", factory set for 1-3/4"
Strike	Full lip 1-3/8" x 2-3/4", round corners
Latch	2-3/8" - 2-3/4" adjustable backset, 1" front, round corners
Cylinder	Standard: 5-pin, solid brass, 2 brass keys
Handing	Non-handed
Case Quantity	5

Available Finishes	Arrow Code	BHMA Code	U.S. Code
Bright Brass	03	605	US3
Dark Oxidized Satin Bronze, Clear Coated	10BP	614	US10BL
Satin Nickel	15	619	US15

How to Order	
Function & Trim	V351-LR
Finish	V351-LR-03
Strike	V351-LR-03-V3S
Latch	V351-LR-03-V3S-V3L
Keying	V351-LR-03-V3S-V3L-CSKD

Strike Option	Specify
Full lip 1-3/8" x 2-3/4"	V3S

Latch Option	Specify
2-3/8" - 2-3/4" adjustable backset, 1" front	V3L

Keying & Cylinder Option	Specify
Keyed different, CS keyway	CSKD

Parts & Accessories	Part No.
Cylinder	100C-V3
Strike	V3S
Latch	V3L
Drive-in Latch ¹	V3LD
Display mount	MOUNT-V23

¹ Sold only as a separate part.

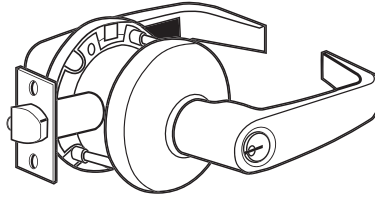

**DISCONTINUED. LIMITED AVAILABILITY THROUGH DISTRIBUTION ONLY.
CONTACT CUSTOMER SERVICE FOR ADDITIONAL INFORMATION.**

Features

Certification	BHMA A156.2, Series 4000, Grade 1, UL Listed
Door Thickness	1-3/4"
Strike	Standard: ANSI 1-1/4" x 4-7/8"; alternate strikes available
Latch	Standard: 2-3/4" backset, 1-1/8" front; 3-3/4" backset available
Cylinder	Standard: 6-pin, solid brass, 2 nickel-silver keys; IC prep available
Handing	Non-handed
Case Quantity	10
Average Case Weight	46 lbs.
Warranty	3 years

Available Finishes	Arrow Code	BHMA Code	U.S. Code
Bright brass	03	605	US3
Satin brass	04	606	US4
Satin bronze	10	612	US10
Dark oxidized satin bronze, oil rubbed	10B	613	US10B
Bright chromium plated	26	625	US26
Satin chromium plated	26D	626	US26D

How to Order

Function	Q11
Trim	Q11-SR
Finish	Q11-SR-26D
Strike	Q11-SR-26D-306
Latch	Q11-SR-26D-306-161

Q Series Standard Functions

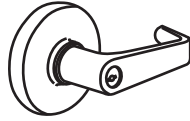

SR Trim

**DISCONTINUED. LIMITED AVAILABILITY THROUGH DISTRIBUTION ONLY.
CONTACT CUSTOMER SERVICE FOR ADDITIONAL INFORMATION.**

Non-Keyed Functions

Function	ANSI	Description	26D	03, 04, 10, 10B, 26
Q01	F75	Passage	\$327.68	\$343.68
Q02	F76	Privacy	\$399.53	\$415.53
Q03	F111	Communicating Passage	\$327.68	\$335.68
Q06	F76	Hospital Privacy	\$449.08	\$465.08
Q07	F89	Exit	\$399.53	\$415.53

Single Cylinder Functions

Function	ANSI	Description	26D	03, 04, 10, 10B, 26
Q11	F109 (F81 & F82)	Entrance/Office	\$441.09	\$457.09
Q12	F86	Storeroom	\$441.09	\$457.09
Q13	F82	Exterior	\$441.09	\$457.09
Q14	F92	Service Station	\$476.23	\$492.23
Q15 ¹	F93	Hotel	\$556.16	\$572.16
Q17	F84	Classroom	\$441.09	\$457.09
Q19	F90	Dormitory	\$476.23	\$492.23

Double Cylinder Functions

Function	ANSI	Description	26D	03, 04, 10, 10B, 26
Q31	F80	Communicating	\$528.93	\$544.93
Q32	F88	Public Entrance	\$528.93	\$544.93
Q33	F87	Asylum	\$528.93	\$544.93
Q35	F91	Exterior	\$528.93	\$544.93
Q37	F110	Intruder Classroom	\$556.16	\$572.16

¹ Hotel function with IC option is only available for 6-pin SFIC core cylinder.

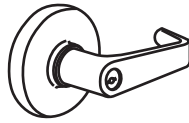

SR Trim

Q Series Overdrive™ Functions

**DISCONTINUED. LIMITED AVAILABILITY THROUGH DISTRIBUTION ONLY.
CONTACT CUSTOMER SERVICE FOR ADDITIONAL INFORMATION.**

Non-Keyed Functions

Function	ANSI	Description	26D	03, 04, 10, 10B, 26
Q72	F76	Privacy	\$412.31	\$428.31
Q76	F76	Hospital Privacy	\$461.86	\$477.86
Q77	F89	Exit	\$412.31	\$428.31

Single Cylinder Functions

Function	ANSI	Description	26D	03, 04, 10, 10B, 26
Q81	F109 (F81 & F82)	Entrance/Office	\$453.85	\$469.85
Q82	F86	Storeroom	\$453.85	\$469.85
Q83	F82	Exterior	\$453.85	\$469.85
Q84	F92	Service Station	\$489.01	\$505.01
Q87	F84	Classroom	\$453.85	\$469.85
Q89	F90	Dormitory	\$489.01	\$505.01

Double Cylinder Functions

Function	ANSI	Description	26D	03, 04, 10, 10B, 26
Q91	F80	Communicating	\$541.78	\$557.78
Q92	F88	Public Entrance	\$541.78	\$557.78
Q93	F87	Asylum	\$541.78	\$557.78
Q95	F91	Exterior	\$541.78	\$557.78
Q97	F110	Intruder Classroom	\$569.00	\$585.00

Q Series Options



306



320



302



303

DISCONTINUED. LIMITED AVAILABILITY THROUGH DISTRIBUTION ONLY. CONTACT CUSTOMER SERVICE FOR ADDITIONAL INFORMATION.

Strike Options	Description	Specify	Price Add
ANSI	1-1/4" x 4-7/8", 1-1/4" lip, square corner, no box	306	Standard
T-Strike	1-1/8" x 2-3/4", 1-1/4" lip, square corner, no box	320	No Add
Full Lip D-Type	1-3/4" x 2-1/4", 1-1/4" lip, square corner	302	No Add
Radius D-Type	1-3/4" x 2-1/4", 1-1/4" lip, 1/4" radius corner	303	No Add
Less Strike		LST	-\$8.10
Box Strike	Supplied when specified	WBS	No Add

Latch Options	Description	Specify >>>	Spring Latch	Dead Latch	Price Add
2-3/4" Backset	1-1/8", square corner		160	161	Standard
	Drive-in		-	164	No Add
3-3/4" Backset	1-1/8", square corner		165	166	\$63.40
Less latch				LAT	-\$16.60

Keying & Cylinder Options	Specify	Price Add
Keyed different	KD	Standard
Master keyed (except Hotel function)	MK	\$12.38 per cylinder
Construction master keyed	CMK	\$7.77 per cylinder
Master keyed & construction master keyed	MK-CMK	\$20.15 per cylinder
O-Bitted	OB	No Add
Less cylinder	LC	-\$8.50
Lock prepared to accept 6 or 7-pin SFIC cylinder, less core	IC	No Add
SR design prepared to accept Medeco or ASSA LFIC cylinder, less core	LIC	\$14.97

Miscellaneous Options	Specify	Price Add
Abrasive outside lever	113	\$55.60
Abrasive inside lever	114	\$55.60
Lead lined roses (inside & outside)	133	\$197.36

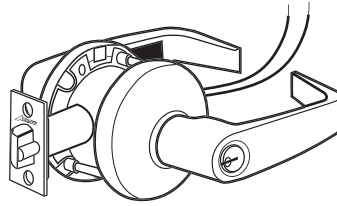

**DISCONTINUED. LIMITED AVAILABILITY THROUGH DISTRIBUTION ONLY.
CONTACT CUSTOMER SERVICE FOR ADDITIONAL INFORMATION.**

Electrification Options

Description	Voltage	Specify	Price Add ¹
Fail-safe trim control (applied to 12 function only)	12V AC/DC	177	\$449.37
	24V AC/DC	179	\$449.37
Fail-secure trim control (applied to 12 function only)	12V AC/DC	181	\$449.37
	24V AC/DC	183	\$449.37

¹ Electrification charges do not include price of locksets.

Fail-safe Power on locks outside lever
 Inside lever always free
 Latch retracted by keys when locked electrically

Fail-secure Power off locks outside lever
 Inside lever always free
 Latch retracted by keys when locked electrically

Specifications 12VAC/VDC @ 250mA 51 ohms
 24VAC/VDC @ 150mA 165.5 ohms

**DISCONTINUED. LIMITED AVAILABILITY THROUGH DISTRIBUTION ONLY.
CONTACT CUSTOMER SERVICE FOR ADDITIONAL INFORMATION.**

Strikes	Description	Specify Finish	Part No.	Price
ANSI	1-1/4" x 4-7/8", 1-1/4" lip, square corner	•	306	\$26.71
T-Strike	1-1/8" x 2-3/4", 1-1/4" lip, square corner	•	320	\$13.47
Full Lip D-Type	1-3/4" x 2-1/4", 1-1/4" lip, square corner	•	302	\$8.48
Radius D-Type	1-3/4" x 2-1/4", 1-1/4" lip, 1/4" radius corner	•	303	\$8.48
Box Strike	Used with 306 ANSI strike		BX70	\$5.08
Box Strike	Used with 320, 302, or 303 strike		BX10	\$5.08

Latches	Description	Specify Finish	Spring Latch No.	Dead Latch No.	Price
2-3/4" Backset	1-1/8", square corner	•	160	161	\$50.74
3-3/4" Backset	1-1/8", square corner, UL	•	165	166	\$114.14
2-3/4" Backset	Drive-in		-	164	\$50.74
5" Extension link	Used only with 160 or 161 latch			H25X5	\$79.21

Cylinder & Related	Specify Finish	Part No.	Price
Standard cylinder (includes tailpiece)	•	600HD	\$25.75
Hotel cylinder	•	H100HD	\$40.12
Standard keyblank		K6A	\$1.29
Standard tailpiece (except hotel function)		1001-44	\$2.60
Hotel function tailpiece		1001H-44	\$2.60
SFIC 6 & 7 pin tailpiece pack (except 19 function)		HSCR-44-201	\$5.03
SFIC 6 & 7 pin tailpiece pack for 19 function		HSTCR-44-201	\$5.03
LFIC tailpiece		HSCRA-44	\$3.02
LFIC tailpiece retainer		HSCRA-66	\$0.42

H Series

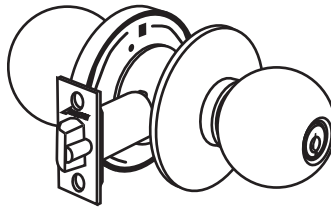

**DISCONTINUED. LIMITED AVAILABILITY THROUGH DISTRIBUTION ONLY.
CONTACT CUSTOMER SERVICE FOR ADDITIONAL INFORMATION.**

Features

Certification	BHMA A156.2, Series 4000, Grade 1, UL Listed
Door Thickness	1-3/4"
Strike	Standard: ANSI 1-1/4" x 4-7/8"; alternate strikes available
Latch	Standard: 2-3/4" backset, 1-1/8" front; 3-3/4" backset available
Cylinder	Standard: 6-pin, solid brass, 2 nickel-silver keys; IC prep available
Handing	Non-handed
Case Quantity	12
Average Case Weight	33 lbs.
Warranty	1 year

Available Finishes	Arrow Code	BHMA Code	U.S. Code
Bright Brass	03	605	US3
Satin Brass	04	606	US4
Satin Bronze	10	612	US10
Bright Chromium Plated	26	625	US26
Dark Oxidized Satin Bronze, Oil Rubbed	10B	613	US10B
Satin Chromium Plated	26D	626	US26D
Satin Stainless Steel	32D	630	US32D

How to Order

Function	H11
Trim	H11-TA
Finish	H11-TA-26D
Strike	H11-TA-26D-306
Latch	H11-TA-26D-306-161
Keying	H11-TA-26D-306-161-KD-AR

H Series

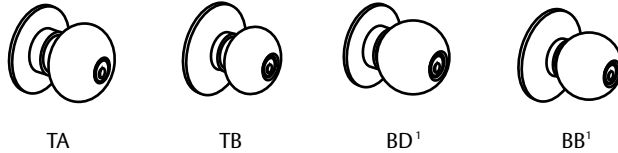

**DISCONTINUED. LIMITED AVAILABILITY THROUGH DISTRIBUTION ONLY.
CONTACT CUSTOMER SERVICE FOR ADDITIONAL INFORMATION.**

Non-Keyed Functions

Function	ANSI	Description	04, 10, 26D	03, 10B, 26	32D
H01	F75	Passage	\$433.12	\$446.48	\$459.72
H02	F76	Privacy	\$530.24	\$543.60	\$556.84
H03	F111	Communicating Passage	\$433.15	\$439.83	\$446.45
H04	F77	Terrace	\$530.24	\$543.60	\$556.84
H05	F78	Communicating	\$555.17	\$568.53	\$581.77
H07	F89	Exit	\$433.12	\$446.48	\$459.72
H08	-	Single Dummy	\$259.88	\$266.56	\$273.18

Single Cylinder Functions

Function	ANSI	Description	04, 10, 26D	03, 10B, 26	32D
H11	F109 (F81 & F82)	Entrance/Office	\$614.15	\$627.51	\$640.75
H12	F86	Storeroom	\$614.15	\$627.51	\$640.75
H13	F82	Exterior	\$614.15	\$627.51	\$640.75
H14	F92	Service Station	\$645.17	\$658.53	\$671.77
H15 ²	F93	Hotel	\$799.83	\$813.19	\$826.43
H17	F84	Classroom	\$614.15	\$627.51	\$640.75
H18	-	Communicating	\$614.17	\$620.85	\$627.47
H19 ¹	F90	Dormitory	\$645.17	\$658.53	\$671.77

Double Cylinder Functions

Function	ANSI	Description	04, 10, 26D	03, 10B, 26	32D
H31	F80	Communicating	\$737.87	\$751.23	\$764.47
H32	F88	Public Entrance	\$737.87	\$751.23	\$764.47
H33	F87	Asylum	\$737.87	\$751.23	\$764.47
H35	F91	Exterior	\$737.87	\$751.23	\$764.47

¹ BD & BB trim designs not offered in 32D finish or available with H19 function.

² Hotel function with IC option is only available for 6-pin SFIC core cylinder.



H Series Options



306



320



302



303

DISCONTINUED. LIMITED AVAILABILITY THROUGH DISTRIBUTION ONLY. CONTACT CUSTOMER SERVICE FOR ADDITIONAL INFORMATION.

Strike Options	Description	Specify	Price Add
ANSI	1-1/4" x 4-7/8", 1-1/4" lip, square corner, no box	306	Standard
T-Strike	1-1/8" x 2-3/4", 1-1/4" lip, square corner, no box	320	No Add
Full Lip D-Type	1-3/4" x 2-1/4", 1-1/4" lip, square corner	302	No Add
Radius D-Type	1-3/4" x 2-1/4", 1-1/4" lip, 1/4" radius corner	303	No Add
Less Strike		LST	-\$8.10
Box Strike	Supplied when specified	WBS	No Add

Latch Options	Description	Specify >>>	Spring Latch	Dead Latch	Price Add
2-3/4" Backset	1-1/8", square corner		160	161	Standard
	Drive-in		-	164	No Add
3-3/4" Backset	1-1/8", square corner		165	166	\$63.40
Less latch				LAT	-\$16.60

Keying & Cylinder Options	Specify	Price Add
Keyed different	KD	Standard
Master keyed	MK	\$12.38 per cylinder
Construction master keyed	CMK	\$7.77 per cylinder
Master keyed & construction master keyed	MK-CMK	\$20.15 per cylinder
O-Bitted	OB	No Add
Less cylinder	LC	-\$8.50
TA or TB design prepared to accept 6 or 7-pin IC cylinder, less core	IC	No Add

Miscellaneous Options	Specify	Price Add
Lead lined knobs (inside & outside)	127	\$263.03
Lead lined roses (inside & outside)	133	\$197.36

**DISCONTINUED. LIMITED AVAILABILITY THROUGH DISTRIBUTION ONLY.
CONTACT CUSTOMER SERVICE FOR ADDITIONAL INFORMATION.**

Strikes	Description	Specify Finish	Part No.	Price
T-Strike	1-1/8" x 2-3/4", 1-1/4" lip, square corner	•	320	\$13.47
ANSI	1-1/4" x 4-7/8", 1-1/4" lip, square corner	•	306	\$26.71
Full Lip D-Type	1-3/4" x 2-1/4", 1-1/4" lip, square corner	•	302	\$8.48
Radius D-Type	1-3/4" x 2-1/4", 1-1/4" lip, 1/4" radius corner	•	303	\$8.48
Box Strike	Used with 306 ANSI strike		BX70	\$5.08
Box Strike	Used with 320, 302, or 303 strike		BX10	\$5.08

Latches	Description	Specify Finish	Spring Latch No.	Dead Latch No.	Price
2-3/4" Backset	1-1/8", square corner	•	160	161	\$50.74
	Drive-in		-	164	\$50.74
3-3/4" Backset	1-1/8", square corner, UL	•	165	166	\$114.14
5" Extension link	Used only with 160 or 161 latch			H25X5	\$79.21

Cylinder & Related	Specify Finish	Part No.	Price
Standard cylinder (includes tailpiece)	•	600HD	\$25.75
Hotel cylinder	•	H100HD	\$40.12
Standard keyblank		K6A	\$1.29
Standard tailpiece (except hotel function)		1001-44	\$2.60
Hotel function tailpiece		1001H-44	\$2.60
IC core cylinder - See Keys & Cylinders section		-	-
6 & 7 pin IC cylinder tailpiece pack (except 15 & 19 functions)		100CR-44-201	\$5.03
6 & 7 pin IC cylinder tailpiece pack for 19 function		100TCR-44-201	\$5.03

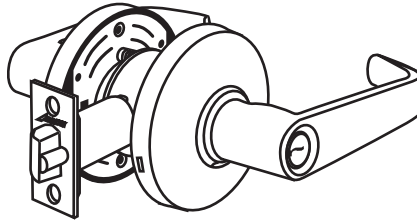

**DISCONTINUED. LIMITED AVAILABILITY THROUGH DISTRIBUTION ONLY.
CONTACT CUSTOMER SERVICE FOR ADDITIONAL INFORMATION.**

Features

Certification	BHMA A156.2, Series 4000, Grade 2, UL Listed
Door Thickness	Fits 1-3/8" - 1-3/4", factory set for 1-3/4"
Strike	Standard: ANSI 1-1/4" x 4-7/8"; alternate strikes available
Latch	Standard: 2-3/4" backset, 1-1/8" front; alternate latches available
Cylinder	Standard: 6-pin, solid brass, 2 nickel-silver keys; IC prep available
Handing	Non-handed
Case Quantity	10
Average Case Weight	42 lbs.
Warranty	3 years

Available Finishes	Arrow Code	BHMA Code	U.S. Code
Bright Brass	03	605	US3
Satin Brass	04	606	US4
Satin Bronze	10	612	US10
Dark Oxideized Satin Bronze, Oil Rubbed	10B	613	US10B
Bright Chromium Plated	26	625	US26
Satin Chromium Plated	26D	626	US26D

How to Order

Function	ML11
Trim	ML11-SR
Finish	ML11-SR-26D
Strike	ML11-SR-26D-306
Latch	ML11-SR-26D-306-161
Keying	ML11-SR-26D-306-161-KD-AR

ML Series Standard Functions

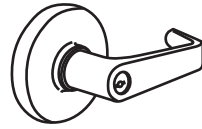

SR Trim

**DISCONTINUED. LIMITED AVAILABILITY THROUGH DISTRIBUTION ONLY.
CONTACT CUSTOMER SERVICE FOR ADDITIONAL INFORMATION.**

Non-Keyed Functions

Function	ANSI	Description	26D	03, 04, 10, 10B, 26
ML01	F75	Passage	\$213.15	\$227.97
ML02	F76	Privacy	\$242.51	\$257.33
ML03	F111	Communicating Passage	\$213.16	\$220.57
ML06	F76	Hospital Privacy	\$297.51	\$312.33
ML07	F89	Exit	\$242.51	\$257.33
ML08	-	Single Dummy Trim	\$188.52	\$195.93
ML09	-	Full Dummy Trim	\$248.65	\$263.47

Single Cylinder Functions

Function	ANSI	Description	26D	03, 04, 10, 10B, 26
ML11	F109 (F81 & F82)	Entrance/Office	\$290.05	\$304.87
ML12	F86	Storeroom	\$290.05	\$304.87
ML13	F82	Exterior	\$290.05	\$304.87
ML14	F92	Service Station	\$333.02	\$347.84
ML17	F84	Classroom	\$290.05	\$304.87

Double Cylinder Functions

Function	ANSI	Description	26D	03, 04, 10, 10B, 26
ML31	F80	Communicating	\$381.94	\$396.76
ML32	F88	Public Entrance	\$381.94	\$396.76
ML33	F87	Asylum	\$381.94	\$396.76
ML35	F91	Exterior	\$381.94	\$396.76

ML Series Overdrive™ Functions

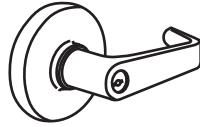

SR Trim

**DISCONTINUED. LIMITED AVAILABILITY THROUGH DISTRIBUTION ONLY.
CONTACT CUSTOMER SERVICE FOR ADDITIONAL INFORMATION.**

Non-Keyed Functions

Function	ANSI	Description	26D	03, 04, 10, 10B, 26
ML72	F76	Privacy	\$254.38	\$269.20
ML76	F76	Hospital Privacy	\$309.38	\$324.20
ML77	F89	Exit	\$254.38	\$269.20

Single Cylinder Functions

Function	ANSI	Description	26D	03, 04, 10, 10B, 26
ML81	F109 (F81 & F82)	Entrance/Office	\$301.94	\$316.76
ML82	F86	Storeroom	\$301.94	\$316.76
ML83	F82	Exterior	\$301.94	\$316.76
ML84	F92	Service Station	\$344.83	\$359.65
ML87	F84	Classroom	\$301.94	\$316.76

Double Cylinder Functions

Function	ANSI	Description	26D	03, 04, 10, 10B, 26
ML91	F80	Communicating	\$393.69	\$408.51
ML92	F88	Public Entrance	\$393.69	\$408.51
ML93	F87	Asylum	\$393.69	\$408.51
ML95	F91	Exterior	\$393.69	\$408.51

ML Series Options



306



300



302



303

**DISCONTINUED. LIMITED AVAILABILITY THROUGH DISTRIBUTION ONLY.
CONTACT CUSTOMER SERVICE FOR ADDITIONAL INFORMATION.**

Strike Options	Description	Specify	Price Add
ANSI	1-1/4" x 4-7/8", 1-1/4" lip, square corner, no box	306	Standard
T-Strike	1-1/8" x 2-3/4", 1-1/4" lip, square corner, no box	300	No Add
Full Lip D-Type	1-3/4" x 2-1/4", 1-1/4" lip, square corner, no box	302	No Add
Radius D-Type	1-3/4" x 2-1/4", 1-1/4" lip, 1/4" radius corner, no box	303	No Add
Less Strike		LST	-\$8.10
Box Strike	Supplied when specified	WBS	No Add

Latch Options	Description	Specify >>>	Spring Latch	Dead Latch	Price Add
	1-1/8", Square Corner		274	284	Standard
2-3/4" Backset	1", Square Corner		-	282	No Add
	1", Round Corner		-	290	No Add
	1", Square Corner		271	281	No Add
2-3/8" Backset	1-1/8", Square Corner		273	283	No Add
	1", Round Corner		279	289	No Add
3-3/4" Backset	1-1/8", Square Corner		278	288	\$20.59
Less Latch				LAT	-\$9.85

Keying & Cylinder Options	Specify	Price Add
Keyed different	KD	Standard
Master keyed	MK	\$12.38 per cylinder
Construction master keyed	CMK	\$7.77 per cylinder
Master keyed & construction master keyed	MK-CMK	\$20.15 per cylinder
O-Bitted	OB	No Add
Less Cylinder	LC	-\$8.50
Lock prepared to accept 6 or 7-pin SFIC cylinder, less core	IC	No Add
SR design prepared to accept Medeco or ASSA LFIC cylinder, less core	LIC	\$14.97

Miscellaneous Options	Specify	Price Add
Abrasive outside lever	113	\$55.60
Abrasive inside lever	114	\$55.60
Lead lined roses (inside & outside)	133	\$197.36

**DISCONTINUED. LIMITED AVAILABILITY THROUGH DISTRIBUTION ONLY.
CONTACT CUSTOMER SERVICE FOR ADDITIONAL INFORMATION.**

Strikes	Description	Specify Finish	Strike No.	Price
ANSI	1-1/4" x 4-7/8", 1-1/4" lip, square corner	•	306	\$26.71
T-Strike	1-1/8" x 2-3/4", 1-1/4" lip, square corner	•	300	\$8.48
Full Lip D-Type	1-3/4" x 2-1/4", 1-1/4" lip, square corner	•	302	\$8.48
Radius D-Type	1-3/4" x 2-1/4", 1-1/4" lip, 1/4" radius corner	•	303	\$8.48
Box Strike	Used with 306 ANSI strike		BX70	\$5.08
Box Strike	Used with 300, 302, or 303 strike		BX10	\$5.08

Latches	Description	Specify Finish	Spring Latch No.	Dead Latch No.	Price
	1-1/8", square corner	•	274	284	\$30.15
2-3/4" Backset	1", square corner	•	-	282	\$30.15
	1", round corner	•	-	290	\$30.15
	1", square corner	•	271	281	\$30.15
2-3/8" Backset	1-1/8", square corner	•	273	283	\$30.15
	1", round corner	•	279	289	\$30.15
3-3/4" Backset	1-1/8", square corner	•	278	288	\$50.74

Cylinder & Related	Specify Finish	Part No.	Price
Standard cylinder (includes tailpiece)	•	600HD	\$25.75
Hotel cylinder	•	H100HD	\$40.12
Standard keyblank		K6A	\$1.29
Standard tailpiece		1001-44	\$2.60
SFIC 6 & 7 pin tailpiece pack (except 15 & 19 functions)		HSCR-44-201	\$5.03
SFIC 6 & 7 pin tailpiece pack for 19 function		HSTCR-44-201	\$5.03
LFIC tailpiece		HSRCM-44	\$3.02
LFIC tailpiece retainer		HSCRA-66	\$0.42

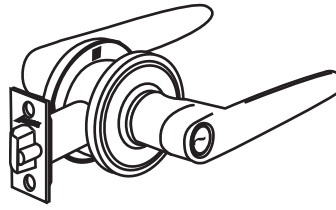

**DISCONTINUED. LIMITED AVAILABILITY THROUGH DISTRIBUTION ONLY.
CONTACT CUSTOMER SERVICE FOR ADDITIONAL INFORMATION.**

Features	
Certification	BHMA A156.2, Series 4000, Grade 2
Door Thickness	Fits 1-3/8" - 1-3/4", factory set for 1-3/4"
Strike	Standard: Full lip 1-5/8" x 2-1/4"; alternate strikes available
Latch	Standard: 2-3/8" - 2-3/4" adj. backset, 1" front; alternate latches available
Cylinder	6-pin, solid brass, 2 brass keys
Handing	Non-handed
Case Quantity	20
Average Case Weight	25 lbs
Warranty	5 years

Available Finishes	Arrow Code	BHMA Code	U.S. Code
Bright Brass	03	605	US3
Satin Brass	04	606	US4
Antique Brass	05A	609	US5
Satin Nickel	15	619	US15
Bright Chromium Plated	26	625	US26
Satin Chromium Plated	26D	626	US26D

How to Order	
Function	CK11
Trim	CK11-TE
Finish	CK11-TE-26D
Strike	CK11-TE-26D-502
Latch	CK11-TE-26D-502-511
Keying	CK11-TE-26D-502-511-KD-AR

CK Series



TE

BE

DE

**DISCONTINUED. LIMITED AVAILABILITY THROUGH DISTRIBUTION ONLY.
CONTACT CUSTOMER SERVICE FOR ADDITIONAL INFORMATION.**

Function	Description	TE	BE	DE
CK01	Passage	\$41.86	\$39.42	\$39.02
CK02	Privacy	\$45.14	\$42.80	\$42.30
CK04	Patio	\$45.14	\$42.80	\$42.30
CK08	Single Dummy	\$21.06	\$19.89	\$19.64
CK11	Entrance	\$76.94	\$74.60	\$74.10
CK12	Storeroom	\$76.94	\$74.60	\$74.10

CK Series Options

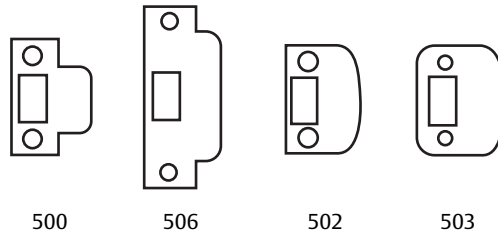

DISCONTINUED. LIMITED AVAILABILITY THROUGH DISTRIBUTION ONLY. CONTACT CUSTOMER SERVICE FOR ADDITIONAL INFORMATION.

Strike Options	Description	Specify	Price Add
T-Strike	1-1/8" x 2-3/4", 1-1/4" lip, square corner	500	No Add
ANSI	1-1/4" x 4-7/8", 1-1/4" lip, square corner	506	\$8.06
Full Lip D-Type	1-3/4" x 2-1/4", 1-1/4" lip, square corner	502	Standard
Radius D-Type	1-3/4" x 2-1/4", 1-1/4" lip, 1/4" radius corner	503	No Add

Latch Options	Description	Specify >>>	Spring Latch	Dead Latch	Price Add
2-3/8" - 2-3/4" Adjustable Backset	Includes 3 faceplates Drive-in		501	511	Standard
Less Latch				515	No Add
				LAT	-\$4.10

Keying & Cylinder Options	Specify	Price Add
Keyed alike in four (quantity permitting otherwise KD)	KA4	Standard
Keyed different	KD	No Add
Master keyed	MK	\$12.38 per cylinder
Construction master keyed	CMK	\$7.77 per cylinder
Master keyed & construction master keyed	MK-CMK	\$20.15 per cylinder
O-Bitted	OB	No Add
Less Cylinder	LC	-\$8.50

CK Series Parts

**DISCONTINUED. LIMITED AVAILABILITY THROUGH DISTRIBUTION ONLY.
CONTACT CUSTOMER SERVICE FOR ADDITIONAL INFORMATION.**

Strikes	Description	Specify Finish	Part No.	Price
T-Strike	1-1/8" x 2-3/4", 1-1/4" Lip, Square Corner	•	500	\$5.08
ANSI	1-1/4" x 4-7/8", 1-1/4" Lip, Square Corner	•	506	\$13.14
Full Lip D-Type	1-3/4" x 2-1/4", 1-1/4" Lip, Square Corner	•	502	\$5.08
Radius D-Type	1-3/4" x 2-1/4", 1-1/4" Lip, 1/4" Radius Corner	•	503	\$5.08

Latches	Description	Specify Finish	Spring Latch No.	Dead Latch No.	Price
2-3/8" - 2-3/4"	Includes 3 faceplates	•	501	511	\$13.14
Adjustable Backset	Drive-in		505	515	\$13.14

Cylinder & Related	Part No.	Price
Standard key blank	K5A	\$1.29

Components for CK Series shipments beginning April 2011	Trim	Part No.	Price
Standard cylinder for CK Series with	TE or DE trim	100YC1	\$25.00
	BE trim	100YC1-750	\$25.00
Standard tailpiece for CK Series with	TE or DE trim	10CB2-44	\$2.48
	BE trim	10CB1-44	\$2.48

Components for CK Series shipments prior to April 2011	Trim	Part No.	Price
Standard cylinder for CK Series with	TE or DE trim	100YC	\$25.00
	BE trim	100YC-750	\$25.00
Standard tailpiece for CK Series with	TE or DE trim	10CL-44	\$2.48
	BE trim	10CB-44	\$2.48

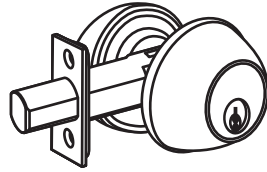

DISCONTINUED. LIMITED AVAILABILITY THROUGH DISTRIBUTION ONLY. CONTACT CUSTOMER SERVICE FOR ADDITIONAL INFORMATION.

Features	
Certification	ANSI A156.5, Grade 2, UL Listed
Door Thickness	Fits 1-3/8" to 1-3/4", factory set to 1-3/4"
Strike	2-3/4" x 1-1/8", round corners
Bolt	2-3/8" - 2-3/4" adjustable backset, 1" front, includes spacer for 1-1/8" prep
Cylinder	6-pin, solid brass, keyed alike in 4, CS keyway, includes 2 brass keys
Handing	Non-handed
Case Quantity	12 per case
Average Case Weight	DB61-22lbs. / DB62-27lbs.
Warranty	1 year

Available Finishes	Arrow Code	BHMA Code	U.S. Code
Bright Brass	03	605	US3
Dark Oxide Satin Bronze, Clear Coated	10BP	614	US10BL
Satin Stainless Steel	32D	630	US32D

How to Order	
Function	DB61
Finish	DB61- 32D
Strike	DB61-32D- 394
Latch	DB61-32D-394- 157
Keying	DB61-32D-394-157- KA4-CS

Function	Description	32D	03, 10B
DB61	Cylinder x Thumbturn	\$42.78	\$50.44
DB62	Double Cylinder	\$60.90	\$68.56

DB Series Options & Parts

**DISCONTINUED. LIMITED AVAILABILITY THROUGH DISTRIBUTION ONLY.
CONTACT CUSTOMER SERVICE FOR ADDITIONAL INFORMATION.**

Strike Option		Specify	Price Add
2-3/4" x 1-1/8", round corners		394	Standard
Bolt Option		Specify	Price Add
2-3/8" to 2-3/4" adjustable backset		157	Standard
Keying & Cylinder Options		Specify	Price Add
Keyed alike in 4, CS keyway		CSKA4	Standard
Keyed alike in 4, AR keyway		ARKA4	No Add
Lock prepared to accept a 6- or 7-pin SFIC cylinder (not included)		IC	\$18.67
Parts	Description	Specify	Price
	DB61 Cylinder, keyed different, CS keyway	95C-CS KD	\$19.43
	DB61 Cylinder, keyed different, AR keyway	95C KD	\$19.43
	DB62 Cylinder, keyed different, CS keyway	95DC-CS KD	\$19.43
	DB62 Cylinder, keyed different, AR keyway	95DC KD	\$19.43
	Strike	394	\$6.27
	Standard bolt	157	\$13.59
	Optional drive-in bolt (sold only as a separate part)	157D	\$13.59
Screw Pack	DB61	DB61-201	\$8.08
	DB62	DB62-201	\$8.08
Thick Door Pack, up to 2"	DB61	DB61-TDP	\$8.08
	DB62	DB62-TDP	\$8.08

900N Series

Discontinued Products

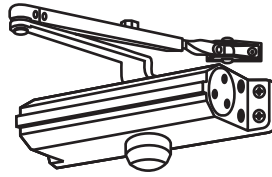

DISCONTINUED. LIMITED AVAILABILITY THROUGH DISTRIBUTION ONLY. CONTACT CUSTOMER SERVICE FOR ADDITIONAL INFORMATION.

Tri-Pack Configurations	Part No.	Price
Standard arm, sizes 1-4	914N	\$245.50
Standard arm, sizes 3-6	936N	\$245.50
Hold-open arm, sizes 1-4	914NH	\$279.74
Hold-open arm, sizes 3-6	936NH	\$279.74

Parts & Accessories	Part No.	Price
Drop plate	936DP	\$40.52
914N Closer body	914BO	\$160.00
936N Closer body	936BO	\$160.00
Thru-bolts for 1-3/8" thick door	5016TB38	\$10.52
Thru-bolts for 1-3/4" thick door	5016TB34	\$10.52
Complete (tri-pack) standard arm assembly	5016CNA	\$77.75
Complete (tri-pack) hold-open arm assembly	5016CHA	\$114.00

- Packed 6 per case. Average case weight 21 lbs.
- Specify AL, DBZ, LBZ, GL, or BLK finish.



ASSA ABLOY

ARROW USA
Phone: 800-839-3157
Fax: 800-421-6615

ARROW CANADA
Phone: 1-800-461-3007
Fax: 1-800-461-8989

Visit us at our Website:
www.arrowlock.com

For more information regarding
Arrow locksets, exit devices,
door closers and key systems,
contact your authorized
Arrow distributor.



E-Newsletter Signup: www.arrowlock.com/newsletter

ASSA ABLOY is the
global leader in door
opening solutions
dedicated to satisfying
end-user needs for
security, safety and
convenience.