



**SILENT
KNIGHT**

by Honeywell

INTELLIKNIGHT® 5600/5600C/ 5600HV

Addressable Fire Control Panel



**Installation and
Operations Manual**

Document 151450
03/08/2013 Rev: E2

151450:E2 ECN: 13-0232

Installation Procedure

Installation Precautions - Adherence to the following will aid in problem-free installation with long-term reliability: **WARNING** - Several different sources of power can be connected to the fire alarm control panel. Disconnect all sources of power before servicing. Control unit and associated equipment may be damaged by removing and/or inserting cards, modules, or interconnecting cables while the unit is energized. Do not attempt to install, service, or operate this unit until manuals are read and understood. **CAUTION** - System Re-acceptance Test after Software Changes: To ensure proper system operation, this product must be tested in accordance with NFPA 72 after any programming operation or change in site-specific software. Re-acceptance testing is required after any change, addition or deletion of system components, or after any modification, repair or adjustment to system hardware or wiring. All components, circuits, system operations, or software functions known to be affected by a change must be 100% tested. In addition, to ensure that other operations are not inadvertently affected, at least 10% of initiating devices that are not directly affected by the change, up to a maximum of 50 devices, must also be tested and proper system operation verified. This system meets NFPA requirements for operation within the range of 0°C-49°C (32°F-120°F) or humidity within the range of 10%-93% at 30°C (86°F) noncondensing. However, the useful life of the system's standby batteries and the electronic components may be adversely affected by extreme temperature ranges and humidity. Therefore, it is recommended that this system and its peripherals be installed in an environment with a normal room temperature of 15-27° C/60-80° F. **Verify that wire sizes are adequate** for all initiating and indicating device loops. Most devices cannot tolerate more than a 10% I.R. drop from the specified device voltage. **Like all solid state electronic devices**, this system may operate erratically or can be damaged when subjected to lightning induced transients. Although no system is completely immune from lightning transients and interference, proper grounding will reduce susceptibility. Overhead or outside aerial wiring is not recommended, due to an increased susceptibility to nearby lightning strikes. Consult with the Technical Services Department if any problems are anticipated or encountered. **Remove DC power** prior to removing or inserting circuit boards. Failure to do so can damage circuits. Remove all electronic assemblies prior to any drilling, filing, reaming, or punching of the enclosure. When possible, make all cable entries from the sides or rear. Before making modifications, verify that they will not interfere with battery, transformer, or printed circuit board location. **Do not tighten screw terminals** more than 9 in-lbs. Over-tightening may damage threads, resulting in reduced terminal contact pressure and difficulty with screw terminal removal. Fire alarm control panels contain static-sensitive components. Always ground yourself with a proper wrist strap before handling any circuits so that static charges are removed from the body. Use static suppressive packaging to protect electronic assemblies removed from the unit.

Follow the instructions in the installation, operating, and programming manuals.

These instructions must be followed to avoid damage to the control panel and associated equipment. FACP (Fire Alarm Control Panel) operation and reliability depend upon proper installation.

Equipment used in the system may not be technically compatible with the control. It is essential to use only equipment listed for service with your control panel.

Telephone lines needed to transmit alarm signals from a premise to a central monitoring station may be out of service or temporarily disabled. **The most common cause** of fire alarm malfunctions, however, is inadequate maintenance. All devices and system wiring should be tested and maintained by professional fire alarm installers following written procedures supplied with each device. System inspection and testing should be scheduled monthly or as required by national and/or local fire codes. Adequate written records of all inspections should be kept.

Contents

Section 1

Introduction 1

1.1	Overview of Basic System	1
1.1.1	Hardware Features	1
1.1.2	Software Features	1
1.2	About this Manual	2
1.2.1	Terms Used in this Manual	2
1.3	Compatible Products	2
1.4	How to Contact Silent Knight	2

Section 2

Agency Listings, Approvals, and Requirements 1

2.1	Federal Communications Commission (FCC)	1
2.2	Underwriters Laboratories (UL)	3
2.2.1	Requirements for All Installations	3
2.2.2	Requirements for Central Station Fire Alarm Systems	4
2.2.3	Requirements for Local Protected Fire Alarm Systems	4
2.2.4	Requirements for Remote Station Protected Fire Alarm Systems	4
2.3	ULC Requirements	4

Section 3

Before You Begin Installing 1

3.1	What's in the Box?	1
3.2	Environmental Specifications	1
3.3	Electrical Specifications	2
3.4	Wiring Specifications	3
3.5	Board Assembly Diagram	5
3.6	Calculating Current Draw and Standby Battery	6
3.6.1	Worksheet Requirements	6
3.6.1.1	Current Draw Worksheet for 5600 for UL 864	7
3.6.1.2	Current Draw Worksheet for 5600 ULC	9
3.6.2	Maximum Battery Standby Load for UL 864	11
3.6.3	Maximum Battery Standby Load for ULC	11

Section 4

Control Panel Installation 1

4.1	Mounting the Control Panel Cabinet	1
4.1.1	Preventing Water Damage	1
4.1.2	Removing the 5600 Assembly from the Housing	1
4.1.3	Dead Front Installation and removal	2

- 4.1.3.1 Installing the Dead Front 2
- 4.1.3.2 Dead Front Removal 3
- 4.2 AC Power Connection 4
 - 4.2.1 AC Power Connection for UL 864 applications 4
 - 4.2.2 AC Power Connection for Canadian Applications 5
- 4.3 Battery Connection 6
 - 4.3.1 RBB Accessory Cabinet 7
 - 4.3.1.1 Installing the RBB Accessory Cabinet and Batteries 7
- 4.4 SBUS Wiring 9
 - 4.4.1 Calculating Wiring distance for SBUS modules 9
 - 4.4.2 Wiring Configurations 12
- 4.5 5635 Remote Annunciator Installation 13
 - 4.5.1 Mounting the 5635 14
- 4.6 Model 5635 Connection to the Panel 15
- 4.7 Configuring Module 16
 - 4.7.1 Assigning Module IDs 16
- 4.8 Telephone Connection 17
- 4.9 Notification Appliance/Auxiliary Power Circuits 18
 - 4.9.1 Conventional Notification Appliance Circuit 18
 - 4.9.2 Auxiliary Power Installation 19
 - 4.9.2.1 Door Holder Power 19
 - 4.9.2.2 Constant Power 20
 - 4.9.2.3 Resettable Power 20
- 4.10 On-Board Relays (Conventional, Power Limited) 21
 - 4.10.1 Common Trouble Relay 21
 - 4.10.2 Programmable Relays 21
- 4.11 Remote Station Applications 22
 - 4.11.1 City Box Connection Using the 5220 Module 22
 - 4.11.2 NFPA 72 Polarity Reversal 24
 - 4.11.2.1 Alarm, Supervisory and Trouble Reverse Polarity Outputs 24

Section 5
SLC Device Installation 1

- 5.1 List of SLC Devices 1
- 5.2 Maximum Number of Devices 1
- 5.3 Wiring Requirements for SLC Devices 2
 - 5.3.1 Wiring SLC in Style 4 (Class B) Configuration 2
- 5.4 Wiring SLC Detectors 5
- 5.5 Addressing SLC Devices 6

Section 6
Programming 1

- 6.1 UL 864 Programming Requirements 1
- 6.2 Control Panel Programming 2
- 6.3 Default Control Panel Configuration. 2
 - 6.3.1 Default Mapping of SLC Inputs to Outputs 2
 - 6.3.2 Mapping of SLC Inputs to Outputs. 3
 - 6.3.3 Default Mapping for the 2 built-in Notification Circuits. 4
 - 6.3.4 Maximum SLC address point count 5

- 6.3.5 Installer Code5
- 6.4 JumpStart AutoProgramming5
- 6.5 Modifying Panel Programming using a PC6
 - 6.5.1 Connecting the panel to a PC6
- 6.6 Panel Programming Options7
 - 6.6.1 System Options7
 - 6.6.1.1 Synchronized Strobes Active When Horns Silenced7
 - 6.6.1.2 Silence/Reset Inhibit Enabled7
 - 6.6.1.3 Water Flow Delay7
 - 6.6.1.4 Installer Code (User ID)7
 - 6.6.1.5 Alarm Verification Time7
 - 6.6.1.6 Auto Test7
 - 6.6.1.7 Low AC Report Delay7
 - 6.6.1.8 Walk Test Reporting8
 - 6.6.1.9 Walk Test duration8
 - 6.6.1.10 Walk Test NAC Time out8
 - 6.6.1.11 Clock Source8
 - 6.6.1.12 Auto Daylight Savings Time8
 - 6.6.1.13 Remote Annunciator8
 - 6.6.2 Zone Programming9
 - 6.6.2.1 SLC Addresses Within Each Zone9
 - 6.6.2.2 Zone Silenceable9
 - 6.6.2.3 Zone Type9
 - 6.6.3 Output Point Programming9
 - 6.6.4 Notification Appliance Circuit (NAC) Programming10
 - 6.6.4.1 Circuit Function10
 - 6.6.4.2 Conventional Notification Circuit Mapping10
 - 6.6.5 Relay Programming Options11
 - 6.6.5.1 General System Relay Silence Option11
 - 6.6.6 Dialer Phone Line Programming Options11
 - 6.6.6.1 Line Prefix11
 - 6.6.6.2 Dial Tone Detection11
 - 6.6.6.3 Line Monitoring Enabled (Y/N)12
 - 6.6.6.4 Dialing Option12
 - 6.6.6.5 Pulse Dialing Format12
 - 6.6.7 Dialer Account programming Options13
 - 6.6.7.1 Account Number13
 - 6.6.7.2 Phone Number13
 - 6.6.7.3 Reporting Format13
 - 6.6.7.4 Reporting Filters13

Section 7
System Operation1

- 7.1 System Reset1
- 7.2 Lamp Test1
- 7.3 System Silence1
- 7.4 Acknowledge1
- 7.5 Viewing Active Alarm Points1
- 7.6 Viewing Active Supervisory Points2
- 7.7 Viewing Active Trouble Points2
- 7.8 Walk Test2

- 7.9 Fire Drill2
- 7.10 Zone Disable Feature3
- 7.11 Disabling Notification Circuits3
- 7.12 Loss of AC power3
- 7.13 Remote Connection Feature
(ULC Installations Only) 3
- 7.14 Low Battery4
- 7.15 Ground Fault4
- 7.16 Phone Line Monitoring4
- 7.17 Reporting Account Monitoring4
- 7.18 SLC Fault4
- 7.19 Dialer Error4
- 7.20 Annunciator Description5
 - 7.20.1 LCD Displays5
 - 7.20.2 Banner6
- 7.21 Basic Operation7
 - 7.21.1 Conduct a Fire Drill7
 - 7.21.2 Conduct an Indicator Test7
 - 7.21.3 Silence alarms or troubles7
 - 7.21.4 Reset alarms7
 - 7.21.5 View Alarms or Troubles7
- 7.22 Operation Mode Behavior8

Section 8

Reporting1

- 8.1 Receivers Compatible with the Control Panel1
- 8.2 Reporting Formats Dialer Outputs1

Section 9

Trouble Shooting and Quick Tips1

- 9.1 Troubleshooting1
 - 9.1.1 JumpStart1
 - 9.1.2 View Active Points1
 - 9.1.3 Disable Or Re-Enable A Zone1
 - 9.1.4 Silence the Board PZT1
 - 9.1.5 Silence the Notification Appliances1
 - 9.1.6 To Initiate a Fire Drill2
 - 9.1.7 For a Dialer Test2
 - 9.1.8 For a Lamp Test2
 - 9.1.9 AC LED2
 - 9.1.10 Walk Test2
 - 9.1.11 Seven Segment Display2
- 9.2 Web Server Menus3
 - 9.2.1 To add a smoke detector:3
 - 9.2.2 To add a notification appliance (fire bell)3
 - 9.2.3 To add a Remote Annunciator (DIP switch address 1 or 2)3
 - 9.2.4 To add custom Zone name4
 - 9.2.5 To trip an SLC notification appliance4
 - 9.2.6 To trip a Door Holder4

Appendix A
Compatible Devices1
Silent Knight Fire Product Warranty and Return Policy
Manufacturer Warranties and Limitation of Liability
Model 5600/5600C/5600HV Basic Operating Instructions

Section 1

Introduction

The 5600 Fire Alarm Control / Communicator is an addressable fire control system that meets the requirements of UL 864, ULC 527, and ULC 559. Unless otherwise indicated, all references to 5600 also refer to 5600C and 5600HV.

1.1 Overview of Basic System

1.1.1 Hardware Features

- The 5600 has one signaling line circuit (SLC) that supports 25 Honeywell Fire Systems (HFS) or SK SLC devices, and one SBUS circuit that supports two remote annunciators.
- 2.0A of output power is available through 2 sets of terminals for notification appliance circuits or 1.0A for auxiliary power applications. Each circuit is power limited per UL 864 and can source up to 2.0A

Note: Total output power for all three circuits must not exceed 2.0A.

- Built-in dual phone line, digital alarm communicator/transmitter (DACT).
- Reports events to central station by zone.
- Two general purpose Form C programmable relays.
- One Form C Trouble Relay.

1.1.2 Software Features

- The 5600 is an addressable panel that operates like a 5 zone conventional panel.
- Advanced addressable smoke detector features:
 - Automatic drift compensation
 - Maintenance alert region
 - Point status meets calibrated smoke test requirements for NFPA 72
- Auto learn “JumpStart” feature for easy programming.
- A choice of output patterns available for notification outputs, including ANSI 3.41 temporal signal.
- Built-in synchronization appliance support for Amseco, Gentex[®], Wheelock[®], or System Sensor[®].

1.2 About this Manual

This manual is intended to be a complete reference for all installation and operation tasks for the 5600. Please let us know if the manual does not meet your needs in any way. We value your feedback!

1.2.1 Terms Used in this Manual

The following terminology is used with the 5600 system:

Term	Description
SLC	Signaling Line Circuit
Input Point	An addressable sensing device, such as a smoke or heat detector or a contact monitor device.
Input Zone	A protected area made up of input points.
Output Point (or Output Circuit)	A notification point or circuit for notification appliances. Relay circuits and auxiliary power circuits are also considered output points.
Output (or "Cadence") Pattern	The pattern that the output will use, for example, Constant or ANSI 3.41.

1.3 Compatible Products

See Section 5.1 for a list of compatible SLC devices from Silent Knight for use with the 5600.

See Appendix A for a list of compatible notification appliances.

1.4 How to Contact Silent Knight

If you have a question or encounter a problem not covered in this manual, contact Silent Knight Technical Support at 800-446-6444.

To order parts, contact Silent Knight Customer Service at 800-328-0103 or 203-484-7161.

Limitations of Fire Alarm Systems

Manufacturer recommends that smoke and/or heat detectors be located throughout a protected premise following the recommendations of the current edition of the National Fire Protection Association Standard 72 (NFPA 72), manufacturer's recommendations, State and local codes, and the recommendations contained in Guide for the Proper Use of System Smoke Detectors, which is made available at no charge to all installing dealers. A study by the Federal Emergency Management Agency (an agency of the United States government) indicated that smoke detectors may not go off or give early warning in as many as 35% of all fires. While fire alarm systems are designed to provide warning against fire, they do not guarantee warning or protection against fire. A fire alarm system may not provide timely or adequate warning, or simply may not function, for a variety of reasons. For example:

- Particles of combustion or smoke from a developing fire may not reach the sensing chambers of smoke detectors because:

Barriers such as closed or partially closed doors, walls, or chimneys may inhibit particle or smoke flow.

Smoke particles may become cold, stratify, and not reach the ceiling or upper walls where detectors are located.

Smoke particles may be blown away from detectors by air outlets

Smoke particles may be drawn into air returns before reaching the detector.

In general, smoke detectors on one level of a structure cannot be expected to sense fires developing on another level.

- The amount of smoke present may be insufficient to alarm smoke detectors. Smoke detectors are designed to alarm at various levels of smoke density. If such density levels are not created by a developing fire at the location of detectors, the detectors will not go into alarm.
- Smoke detectors, even when working properly, have sensing limitations. Detectors that have photo electronic sensing chambers tend to detect smoldering fires better than flaming fires, which have little visible smoke. Detectors that have ionizing-type sensing chambers tend to detect fast flaming fires better than smoldering fires. Because fires develop in different ways and are often unpredictable in their growth, neither type of detector is necessarily best and a given type of detector may not provide adequate warning of a fire.
- Smoke detectors are subject to false alarms and nuisance alarms and may have been disconnected by users. For example, a smoke detector located in or near a kitchen may go into nuisance alarm during normal operation of kitchen appliances. In addition, dusty or steamy environments may cause a smoke detector to falsely alarm. If the location of a smoke detector causes an abundance of false alarms or nuisance alarms, do not disconnect the smoke detector; call a professional to analyze the situation and recommend a solution.
- Smoke detectors cannot be expected to provide adequate warning of fires caused

by arson, children playing with matches (especially within bedrooms), smoking in bed, violent explosions (caused by escaping gas, improper storage of flammable materials, etc.).

- Heat detectors do not sense particles of combustion and are designed to alarm only when heat on their sensors increases at a predetermined rate or reaches a predetermined level. Heat detectors are designed to protect property, not life.
- Warning devices (including horns, sirens, and bells) may not alert people or wake up sleepers who are located on the other side of closed or partially open doors. A warning device that activates on a different floor or level of a dwelling or structure is less likely to awaken or alert people. Even persons who are awake may not notice the warning if the alarm is muffled by noise from a stereo, radio, air conditioner or other appliance, or by passing traffic. Audible warning devices may not alert the hearing-impaired (strobes or other devices should be provided to warn these people). Any warning device may fail to alert people with a disability, deep sleepers, people who have recently used alcohol or drugs, or people on medication or sleeping pills.

Please note that:

- i) Strobes can, under certain circumstances, cause seizures in people with conditions such as epilepsy.
 - ii) Studies have shown that certain people, even when they hear a fire alarm signal, do not respond or comprehend the meaning of the signal. It is the property owner's responsibility to conduct fire drills and other training exercises to make people aware of fire alarm signals and instruct on the proper reaction to alarm signals.
 - iii) In rare instances, the sounding of a warning device can cause temporary or permanent hearing loss.
- Telephone lines needed to transmit alarm signals from a premises to a central station may be out of service or temporarily out of service. For added protection against telephone line failure, backup radio transmission systems are recommended.
 - System components, though designed to last many years, can fail at any time. As a precautionary measure, it is recommended that smoke detectors be checked, maintained, and replaced per manufacturer's recommendations.
 - System components will not work without electrical power. If system batteries are not serviced or replaced regularly, they may not provide battery backup when AC power fails.
 - Environments with high air velocity or that are dusty or dirty require more frequent maintenance.

In general, fire alarm systems and devices will not work without power and will not function properly unless they are maintained and tested regularly.

While installing a fire alarm system may make the owner eligible for a lower insurance rate, an alarm system is not a substitute for insurance. Property owners should

continue to act prudently in protecting the premises and the people in their premises and should properly insure life and property and buy sufficient amounts of liability insurance to meet their needs.

Requirements and recommendations for proper use of fire alarm systems including smoke detectors and other fire alarm devices:

Early fire detection is best achieved by the installation and maintenance of fire detection equipment in all rooms and areas of the house or building in accordance with the requirements and recommendations of the current edition of the National Fire Protection Association Standard 72, *National Fire Alarm Code* (NFPA 72), the manufacturer's recommendations, State and local codes and the recommendations contained in Guide for the Proper Use of System Smoke Detectors, which is made available at no charge to all installing dealers. For specific requirements, check with the local Authority Having Jurisdiction (ex. Fire Chief) for fire protection systems.

Requirements and Recommendations include:

- Smoke Detectors shall be installed in sleeping rooms in new construction and it is recommended that they shall also be installed in sleeping rooms in existing construction.
- It is recommended that more than one smoke detector shall be installed in a hallway if it is more than 30 feet long.
- It is recommended that there shall never be less than two smoke detectors per apartment or residence.
- It is recommended that smoke detectors be located in any room where an alarm control is located, or in any room where alarm control connections to an AC source or phone lines are made. If detectors are not so located, a fire within the room could prevent the control from reporting a fire.
- All fire alarm systems require notification devices, including sirens, bells, horns, and/or strobes. In residential applications, each automatic alarm initiating device when activated shall cause the operation of an alarm notification device that shall be clearly audible in all bedrooms over ambient or background noise levels (at least 15dB above noise) with all intervening doors closed.
- It is recommended that a smoke detector with an integral sounder (smoke alarm) be located in every bedroom and an additional notification device be located on each level of a residence.
- To keep your fire alarm system in excellent working order, ongoing maintenance is required per the manufacturer's recommendations and UL and NFPA standards. At a minimum the requirements of Chapter 14 of NFPA 72, 2010 Edition shall be followed. A maintenance agreement should be arranged through the local manufacturer's representative. Maintenance should be performed annually by authorized personnel only.

The most common cause of an alarm system not functioning when a fire occurs is inadequate maintenance. As such, the alarm system should be tested weekly to make sure all sensors and transmitters are working properly.

Section 2

Agency Listings, Approvals, and Requirements

Install and maintain in accordance with NFPA 72. Detector spacing shall be in accordance to NFPA 72. End-of -line relays and resistors shall be placed within the electrical box located and the end of the initiating circuit. Testing and maintenance should be performed according to NFPA 72.

2.1 Federal Communications Commission (FCC)

The following information must be provided to the telephone company before the 5600 can be connected to the phone lines:

A	Manufacturer:	Honeywell International Inc.
B	Model Number:	5600
C	FCC registration number:	US: AC6AL05B205600
	Ringer equivalence:	0.5B
D	Type of jack:	RJ31X
E	Facility Interface Codes:	Loop Start: 02LS2 Ground Start: 02GS2
F	Service Order Code:	9.0F

1. This device may not be directly connected to coin telephone or party line services.
2. This device cannot be adjusted or repaired in the field. In case of trouble with the device, notify the installing company or return to:

Silent Knight
12 Clintonville Road
Northford, CT 06472-1610
203-484-7161

3. If the 5600 causes harm to the telephone network, the telephone company will notify the user in advance that temporary discontinuance of service may be required. If advance notice is not practical, the telephone company will notify the user as soon as possible. Users have the right to file complaints, if necessary, with the Federal Communications Commission.

4. The telephone company may make changes in its facilities, equipment, operations, or procedures that could affect the operation of the equipment. If this happens, the telephone company will provide advance notice to allow you to make the necessary modifications to maintain uninterrupted service.

Warning

This device has been verified to comply with FCC Rules Part 15. Operation is subject to the following conditions: (1) This device may not cause radio interference, and (2) This device must accept any interference received, including interference that may cause undesired operation.

- a) This equipment complies with Part 68 of the FCC rules and the requirements adopted by the ACTA. On the wiring diagram of this equipment is a label that contains, among other information, a product identifier in the format US: AC6AL05B-205600. If requested, this number must be provided to the telephone company.
- b) See Section 4.8 for phone jack information.
- c) A plug and jack used to connect this equipment to the premises wiring and telephone network must comply with the applicable FCC Part 68 rules and requirements adopted by the ACTA. A compliant telephone cord and modular plug is provided with this product. It is designed to be connected to a compatible modular jack that is also compliant. See installation instructions for details.
- d) The REN is used to determine the number of devices that may be connected to a telephone line. Excessive RENs on a telephone line may result in the devices not ringing in response to an incoming call. In most but not all areas, the sum of RENs should not exceed five (5.0). To be certain of the number of devices that may be connected to a line, as determined by the total RENs, contact the local telephone company. For products approved after July 23, 2002, the REN for this product is part of the product identifier that has the format US: AC6AL05B-205600. The digits represented by ## are the REN without a decimal point (e.g., 03 is a REN of 0.3). For earlier products, the REN is separately shown on the label.
- e) If this equipment 5600 causes harm to the telephone network, the telephone company will notify you in advance that temporary discontinuance of service may be required. But if advance notice isn't practical, the telephone company will notify the customer as soon as possible. Also, you will be advised of your right to file a complaint with the FCC if you believe it is necessary.
- f) The telephone company may make changes in its facilities, equipment, operations or procedures that could affect the operation of the equipment. If this happens the telephone company will provide advance notice in order for you to make necessary modifications to maintain uninterrupted service.
- g) If trouble is experienced with this equipment 5600, for repair or warranty information, please contact Silent Knight. If the equipment is causing harm to the telephone network, the telephone company may request that you disconnect the equipment until the problem is resolved.
- h) See warranty in back of this manual for repair and replacement information.

- i) Connection to party line service is subject to state tariffs. Contact the state public utility commission, public service commission or corporation commission for information.
- j) If your home has specially wired alarm equipment connected to the telephone line, ensure the installation of this 5600 does not disable your alarm equipment. If you have questions about what will disable alarm equipment, consult your telephone company or qualified installer.

Electrical Safety Advisory:

Parties responsible for equipment requiring AC power should consider including an advisory notice in their customer information suggesting the customer use a surge arrester. Telephone companies report that electrical surges, typically lightning transients, are very destructive to customer terminal equipment connected to AC power sources. This has been identified as a major nationwide problem.

2.2 Underwriters Laboratories (UL)

2.2.1 Requirements for All Installations

General requirements are described in this section. When installing an individual device, refer to the specific section of the manual for additional requirements. The following subsections list specific requirements for each type of installation (for example, Central Station Fire Alarm systems, Local Protected Fire Alarm systems, and so on).

1. All field wiring must be installed in accordance with NFPA 70 National Electric Code.
2. Use ONLY the addressable smoke detectors specified in Section 5.1 of this manual.
3. Use UL listed notification appliances compatible with the 5600, choose from those specified in the *Appendix* at the back of this manual.
4. A full system checkout must be performed any time the panel is programmed.

Restricted Options:

- The loss of AC signal is defaulted to 3 hours however the system allows settings from 0 - 30 hours. For UL certified installations this number must be set from 1 to 3 hours.
- The system allows the Alarm Verification time to be set from 1 to 255 seconds. For UL certified installations the setting must be a maximum of 60 seconds.
- Call forwarding shall not be used.
- Waterflow and Supervisory have to be set to Latching as shown in the restricted options table in Section 6. See Table 6-1:.

2.2.2 Requirements for Central Station Fire Alarm Systems

1. Use both phone lines. Enable phone line monitors for both lines.
2. You must program a phone number and a test time so that the 5600 sends an automatic daily test to the central station.
3. The AC Loss Hours option must be set from 1-3 hours.

2.2.3 Requirements for Local Protected Fire Alarm Systems

At least one UL listed supervised notification appliance must be used.

2.2.4 Requirements for Remote Station Protected Fire Alarm Systems

1. Do not exceed the current load restrictions shown in Section 3.6.
2. The AC Loss Hours option must be set from 1-3 hours.

2.3 ULC Requirements

Install in accordance with the Canadian Electrical Code, C22.1, Part 1, Section 32.

Section 3

Before You Begin Installing

This section of the manual is intended to help you plan your tasks to facilitate a smooth installation. Please read this section thoroughly, especially if you are installing a 5600 panel for the first time.

3.1 What's in the Box?

The 5600 ships with the following hardware:

- A cabinet with all hardware assembled
- Two keys for the front door
- Installation and Operation manual P/N 151450.
- Ten 4.7K ohm end-of-line resistors
- A battery cable for batteries wired in series

3.2 Environmental Specifications

It is important to protect the 5600 control panel from water. To prevent water damage, the following conditions should be AVOIDED when installing the units:

- Intended for indoor use in dry locations only
- Do not mount directly on exterior walls, especially masonry walls (condensation)
- Do not mount directly on exterior walls below grade (condensation)
- Protect from plumbing leaks
- Protect from splash caused by sprinkler system inspection ports
- Do not mount in areas with humidity-generating equipment (such as dryers, production machinery)

When selecting a location to mount the 5600 control panel, the unit should be mounted where it will NOT be exposed to temperatures outside the range of 0°C-49°C (32°F-120°F) or humidity outside the range of 10%-93% at 30°C (86°F) noncondensing.

3.3 Electrical Specifications

Table 3-1 list the electrical specifications for the 5600 field wiring as well as a description of the each individual terminal and their respective electrical rating. For location of the terminals refer to 3.5. See also Section 4 for installation.

Table 3-1: Terminal Descriptions

Terminal Block	Label		Description	Rating		Earth Ground Fault Impedance			
	Group	Individual		Voltage	Current	Ohms			
TB 1	SBUS	-	SBUS Power	27.4 VDC	100 mA	0Ω			
		+							
		A	SBUS Communication				3.3 VDC	10 mA	0Ω
		B							
	SLC Out	-	SLC Terminals	24 VDC	100 mA	0Ω			
		+							
	*NAC1	-	Notification Appliance Circuit	24 VDC	2.0 Amp	0Ω			
		+	Auxiliary power		1.0 Amp				
	*NAC2	-	Notification Appliance Circuit	24 VDC	2.0 Amp	0Ω			
		+	Auxiliary power		1.0 Amp				
	TROUBLE	NO	Normally open relay contact	24 VDC	2.5 A, resistive	N/A			
		COM	Common terminal						
		NC	Normally closed relay contact						
	RELAY 1	NO	Normally open relay contact	24 VDC	2.5 A, resistive	N/A			
		COM	Common terminal						
		NC	Normally closed relay contact						
	RELAY 2	NO	Normally open relay contact	24 VDC	2.5 A, resistive	N/A			
		COM	Common terminal						
NC		Normally closed relay contact							
TB 2	TELCO 1	RING	Phone Line 1 Telco Ring	N/A	N/A	N/A			
		TIP	Phone Line 1 Telco Tip						
	PHONE 1	RING	Phone Line 1 Phone Ring						
		TIP	Phone Line 1 Phone Tip						
	TELCO 2	RING	Phone Line 2 Telco Ring						
		TIP	Phone Line 2 Telco Tip						
	PHONE 2	RING	Phone Line 2 Phone Ring						
		TIP	Phone Line 2 Phone Tip						

* Regulated for NAC circuits

* Special application when used for auxiliary power circuits.

3.4 Wiring Specifications

Induced noise (transfer of electrical energy from one wire to another) can interfere with telephone communication or cause false alarms. To avoid induced noise, follow these guidelines:

- Isolate input wiring from high current output and power wiring. Do not pull one multi-conductor cable for the entire panel. Instead, separate the wiring as follows:

High voltage	AC power Terminals
SLC loops	Phone line circuits
Notification circuits	NAC1 through NAC2
Relay circuits	SBUS Wiring

- Do not pull wires from different groups through the same conduit. If you must run them together, do so for as short a distance as possible or use shielded cable. Connect the shield to earth ground at the panel. You must route high and low voltages separately.
- Route the wiring around the inside perimeter of the cabinet. It should not cross the circuit board where it could induce noise into the sensitive microelectronics or pick up unwanted RF noise from the high speed circuits. See Figure 3-1 for an example.
- High frequency noise, such as that produced by the inductive reactance of a speaker or bell, can also be reduced by running the wire through ferrite shield

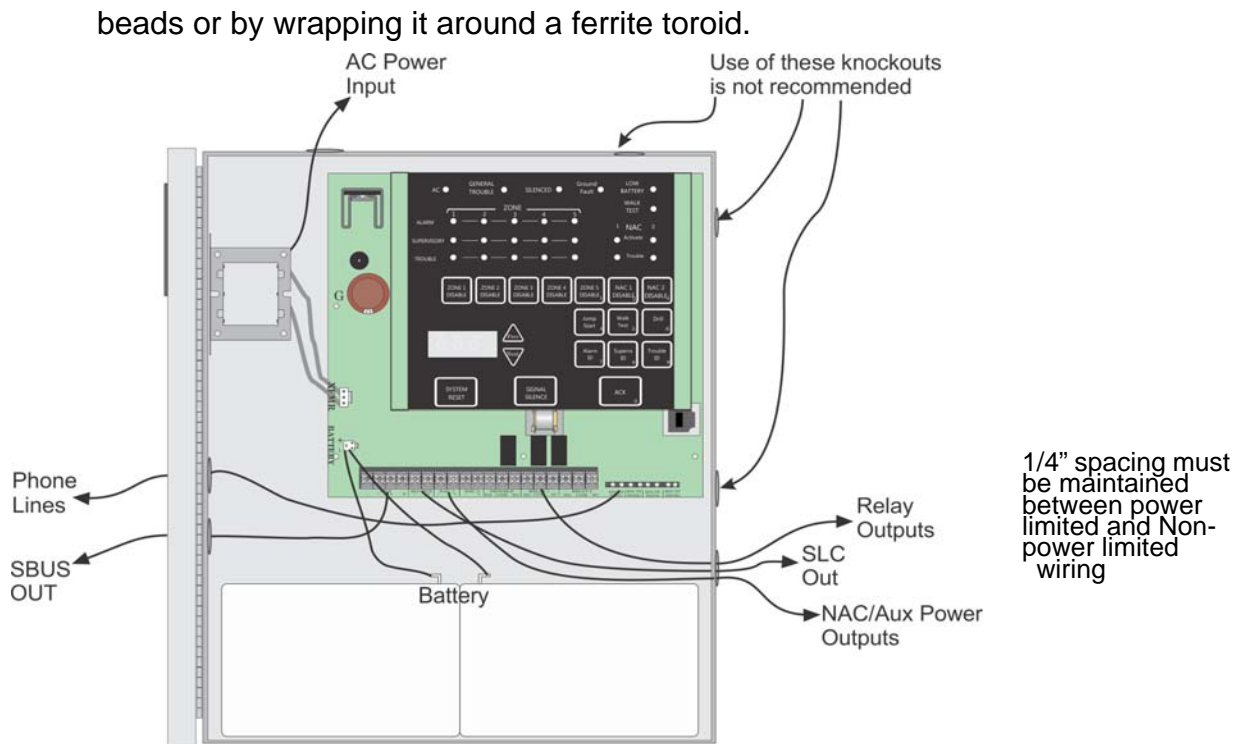

Figure 3-1 Wire Routing Example

3.5 Board Assembly Diagram

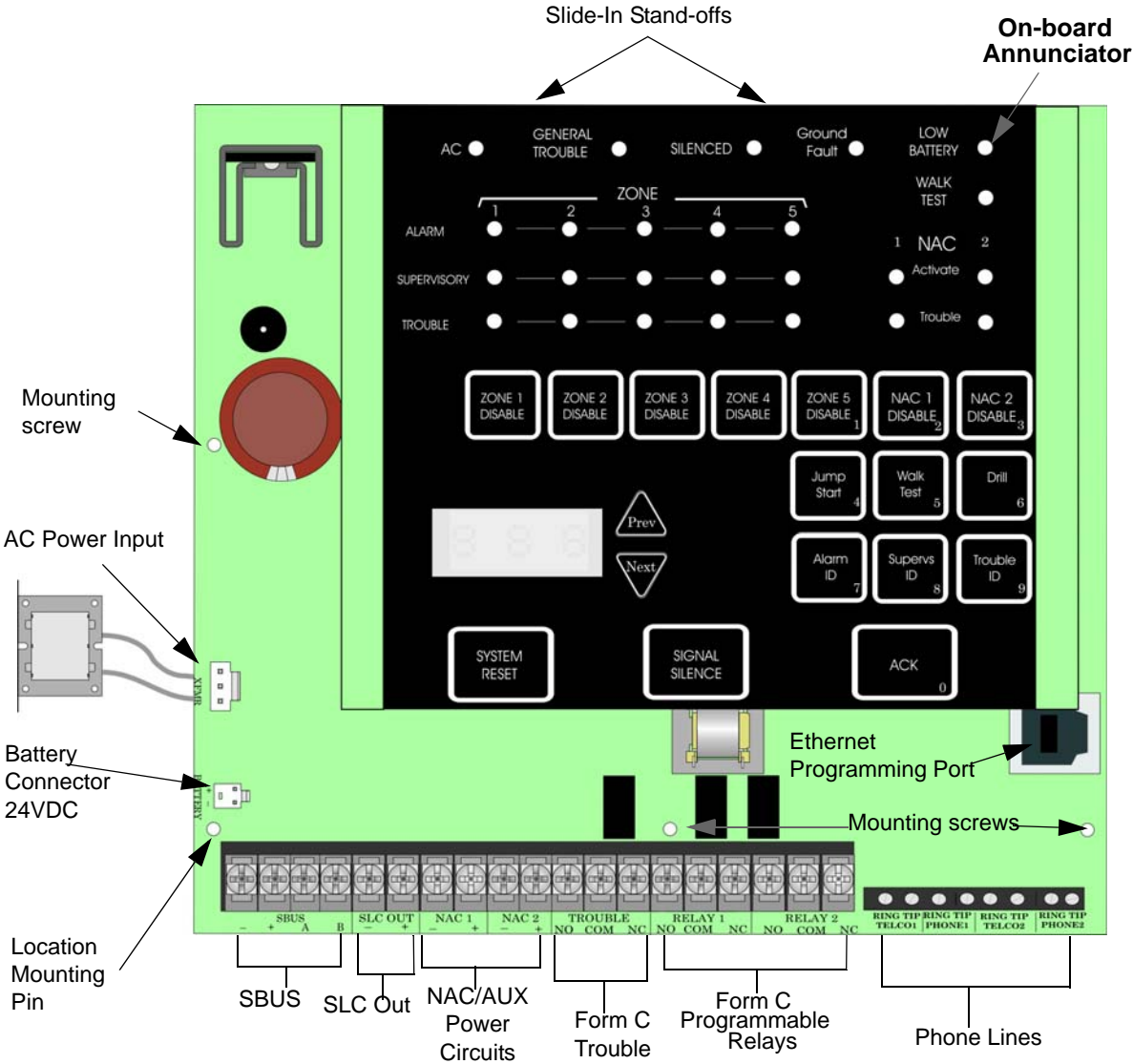

Figure 3-2 Model 5600 Assembly

Figure 3-2 shows the 5600 circuit board stack. If you should need to remove the control board for repair, remove the three mounting screws which hold the control board in the cabinet, slide out of slot from slide-in standoff. Then lift the control board off the location mounting pin and out of the cabinet.

3.6 Calculating Current Draw and Standby Battery

This section is for helping you determine the current draw and standby battery requirements (Table 3-2).

3.6.1 Worksheet Requirements

The following steps must be taken when determining 5600 current draw and standby battery requirements.

1. For the 5600, the worst case current draw is listed for the panel and all addressable devices. Fill in the number of addressable devices that will be used in the system and compute the current draw requirements for alarm and standby. Record this information in the Current Calculation Worksheet at Line A.
2. Add up the current draw for all auxiliary devices and record in the table at Line B.
3. Add up all notification appliance loads and record in the table at Line C.
4. For notification appliance circuits and auxiliary devices not mentioned in the manual, refer to the device manual for the current ratings.
5. Make sure that the total alarm current you calculated, including current for the panel itself, does not exceed 2.0 A. This is the maximum alarm current for the 5600 control panel.

If the current is above 2.0 A you will need to use a notification power expander(s) such as the Silent Knight 5495 power module to distribute the power loads so that the 5600 or the power expanders do not exceed their power rating.

6. Complete the remaining instructions in the Current Calculation Worksheet for determining battery size requirements.

3.6.1.1 Current Draw Worksheet for 5600 for UL 864

Use Table 3-2 to determine amp-hour requirements during alarm/battery standby operation. (Copy the page if additional space is required.) You can install up to 25 SLC devices and two 5635 Remote Annunciator.

Table 3-2: Current Calculation Worksheet for SLC Devices

Device	# of Devices	Current per Device	Standby Current	Alarm Current
For each device use this formula: This column X This column = Current per number of devices.				
Fire Panel (Current draw from battery)	1	Standby: 135 mA	135 mA	
		Alarm: 220 mA		220 mA
Accessory Modules				
5635 Remote Annunciator	2	Standby: 37 mA	mA	
		Alarm: 40 mA		mA
Addressable SLC Detectors				
HFS-P	(25 max. detectors or modules in any combination)	Standby: 0.27 mA Alarm: 6.5 mA	mA	mA
HFS-PT			mA	mA
HFS-D			mA	mA
HFS-T			mA	mA
SK-Photo			mA	mA
SK-Photo-T			mA	mA
SK-DUCT			mA	mA
SK-Heat			mA	mA
Addressable SLC Modules				
HFS-MM	(25 max. detectors or modules in any combination)	Standby/Alarm: .375 mA	mA	mA
SK-Pull-SA		Standby/Alarm: .375 mA	mA	mA
SK-PULL-DA		Standby/Alarm: .375 mA	mA	mA
HFS-MR		Standby/Alarm: 0.255mA	mA	mA
SK-Minimon		Standby/Alarm: .375 mA	mA	mA
SK-Relay		Standby/Alarm: .375 mA	mA	mA
SK-ISO	10 max.	Standby/Alarm: .45 mA	mA	mA
Total System Current				
Auxiliary Devices Refer to devices manual for current rating.				
		Alarm/Standby: mA	mA	mA
		Alarm/Standby: mA	mA	mA
		Alarm/Standby: mA	mA	mA
Auxiliary Devices Current				
Notification Appliance Circuits Refer to device manual for current rating.				
		Alarm: mA		mA
		Alarm: mA		mA
		Alarm: mA		mA
		Alarm: mA		mA
Notification Appliances Current				
Total current ratings of all devices in system (line A + line B + C)			mA	mA

A
B
C
D

Table 3-2: Current Calculation Worksheet for SLC Devices

	Device	# of Devices	Current per Device	Standby Current	Alarm Current
E	Total current ratings converted to amperes (line D x .001):			A	A
F	Number of standby hours (24 or 60 for NFPA 72, chapter 1, 1-5.2.5):			H	
G	Multiply lines E and F. Total standby AH			AH	
H	Alarm sounding period in hours. (For example, 5 minutes = .0833 hours)				H
I	Multiply lines E and H. Total alarm AH				AH
J	Add lines G and I. ¹ Total ampere hours required			AH	

1. Use next size battery with capacity greater than required.

3.6.1.2 Current Draw Worksheet for 5600 ULC

Use to determine amp-hour requirements during alarm/battery standby operation. (Copy the page if additional space is required.) You can install up to 25 SLC devices and two 5635 Remote Annunciator. The maximum battery size for ULC installations is 18 Amp/hr.

Table 3-3: Current Calculation Worksheet for SLC Devices for ULC

Device	# of Devices	Current per Device	Standby Current	Alarm Current
For each device use this formula: This column X This column = Current per number of devices.				
Fire Panel (Current draw from battery)	1	Standby: 165 mA	165 mA	
		Alarm: 220 mA		220 mA
Accessory Modules				
5635 Remote Annunciator	2	Standby: 37 mA	mA	
		Alarm: 40 mA		mA
Addressable SLC Detectors				
HFS-PA	25 max.	Standby: .27 mA Alarm: 6.5 mA	mA	mA
HFS-PTA			mA	mA
HFS-DA			mA	mA
HFS-TA			mA	mA
SK-Photo			mA	mA
SK-Photo-T			mA	mA
SK-DUCT			mA	mA
SK-Heat			mA	mA
Addressable SLC Modules				
HFS-MMA	25 max	Standby/Alarm: .375 mA	mA	mA
SK-Pull-SA		Standby/Alarm: .375 mA	mA	mA
SK-PULL-DA		Standby/Alarm: .375 mA	mA	mA
HFS-MRA		Standby/Alarm: .255mA	mA	mA
SK-Minimon		Standby/Alarm: .375 mA	mA	mA
SK-Relay		Standby/Alarm: .375 mA	mA	mA
SK-ISO	10 max	Standby/Alarm: .45 mA	mA	mA
Total System Current				
Auxiliary Devices Refer to devices manual for current rating.				
		Alarm/Standby: mA	mA	mA
		Alarm/Standby: mA	mA	mA
		Alarm/Standby: mA	mA	mA
Auxiliary Devices Current				
Notification Appliance Circuits Refer to device manual for current rating.				
		Alarm: mA		mA
		Alarm: mA		mA
		Alarm: mA		mA
Notification Appliances Current				
Total current ratings of all devices in system (line A + line B + C)			mA	mA
Total current ratings converted to amperes (line D x .001):			A	A

Table 3-3: Current Calculation Worksheet for SLC Devices for ULC

	Device	# of Devices	Current per Device	Standby Current	Alarm Current
F	Number of standby hours (24 or 60 for NFPA 72, chapter 1, 1-5.2.5):			H	
G	Multiply lines E and F.		Total standby AH	AH	
H	Alarm sounding period in hours. (For example, 5 minutes = .0833 hours)				H
I	Multiply lines E and H.		Total alarm AH		AH
J	Add lines G and I. ¹		Total ampere hours required	AH	

1. Use next size battery with capacity greater than required.

3.6.2 Maximum Battery Standby Load for UL 864

Table 3-4 shows the standby load calculations for the 5600 based on 24 hours of standby. The standby load calculations of line D in the Current Draw Calculation Worksheet must be less than the number shown in Table 3-4 for the selected battery size, standby hour and alarm time. The numbers below have a built in 20% de-rating factor for the battery amp hour capacity.

Table 3-4: Maximum Battery Standby loads for 24 Hour Standby

Rechargeable Battery Size	24 hr Standby, 5 mins. Alarm	24 hr Standby, 15 min alarm	24 hr Standby, 20 min alarm
7 AH	226 mA	213 mA	206 mA
12 AH	393 mA	379 mA	372 mA
18 AH	593 mA	579 mA	572 mA
24 AH	793 mA	779 mA	772 mA
33 AH	1.09 A	1.08 A	1.07 A

3.6.3 Maximum Battery Standby Load for ULC

Table 3-5 shows the ULC standby load calculations for the 5600C based on 24 hours of standby. The standby load calculations of line D in the Current Draw Calculation Worksheet must be less than the number shown in Table 3-5 for the selected battery size, standby hour and alarm time. The numbers below have a built in 40% derating factor for the battery amp hour capacity.

Table 3-5: Maximum Battery Standby loads for ULC 24 Hour Standby

Rechargeable Battery Size	24 hr Standby, 5 mins. Alarm	24 hr Standby, 15 min alarm	24 hr Standby, 20 min alarm
7 AH	226 mA	213 mA	206 mA
12 AH	393 mA	379 mA	372 mA
18 AH	529 mA	515 mA	508 mA

Warning

Silent Knight does not support the use of batteries smaller than those listed in Table 3-4. If you use a battery too small for the installation, the system could overload the battery resulting in the installation having less than the required 24 hours standby power. Use Table 3-2 to calculate the correct battery amperes/hour rating needed for your installation. It is recommended that you replace batteries every five years.

Section 4

Control Panel Installation

Caution!

To avoid the risk of electrical shock and damage to the unit, power should be OFF at the control panel while installing or servicing.

4.1 Mounting the Control Panel Cabinet

Read the environmental specifications in Section 3.2 before mounting the 5600 panel.

The 5600 cabinet dimensions are:

12-3/4" W x 15-1/8" H x 3-3/8" D (32.39 cm W x 38.42 cm H x 8.57 cm D).

The 5600 panel should be located within a secured area, where it is accessible to main drop wiring runs and where it can be easily tested and serviced. Building occupants are responsible for maintaining the panel should be able to hear alarms and troubles. When selecting a location, keep in mind that the panel itself is the main source of alarm and trouble annunciation.

When mounting on interior walls, use appropriate screw anchors in plaster. When mounting on concrete, especially when moisture is expected, attach a piece of 3/4 inch plywood to the concrete surface and then attach the 5600 to the plywood. Also mount any other desired components to the plywood.

DO NOT flush-mount the 5600 cabinet.

4.1.1 Preventing Water Damage

Water damage to the fire system can be caused by moisture entering the cabinet through the conduits. Conduits that are installed to enter the top of the cabinet are most likely to cause water problems. Installers should take reasonable precautions to prevent water from entering the cabinet. Water damage is not covered under warranty.

4.1.2 Removing the 5600 Assembly from the Housing

If it should ever be necessary to remove the control panel assembly from the cabinet for repair, do so by removing the screws that hold the control panel in to the cabinet. Do not attempt to disassemble the circuit boards.

4.1.3 Dead Front Installation and removal

This section provides instructions to install and or remove the dead front for the control panel cabinet.

4.1.3.1 Installing the Dead Front

Follow these steps to properly install the dead front panel into the control panel cabinet.

1. Remove the top two annunciator screws, do not discard them they will be reused. See Figure 4-1 for annunciator screw location.
2. Set the dead front into the cabinet as shown in Figure 4-1.
3. Reinsert the two annunciator screws as shown in Figure 4-1.

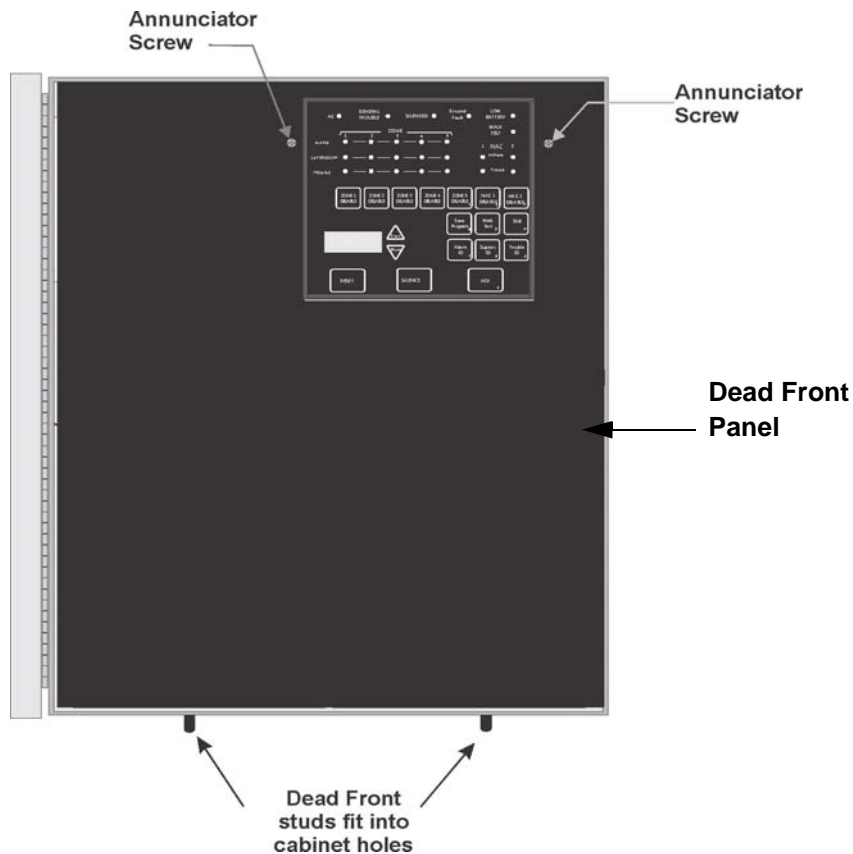

Figure 4-1 Dead Front Installation and Removal

4.1.3.2 Dead Front Removal

Follow these steps to properly remove the dead front panel from the control panel cabinet.

1. Remove the two annunciator screws, do not discard them. See Figure 4-1.
2. Tilt the dead front forward to clear the top of the cabinet and left the dead front out of the cabinet. See Figure 4-1.
3. Reinsert the two annunciator screws. See Figure 4-1.

4.2 AC Power Connection

4.2.1 AC Power Connection for UL 864 applications

At installation, connect the AC terminals to the power source as shown in Figure 4-2. It may be necessary for a professional electrician to make this connection. Connect black and white wires from transformer to 120V power. Connect ground wire from 120V power to screw labeled G on the 5600 circuit board.

The AC power input is rated at 120 VAC, 60 Hz, 1.5A for 5600 and 230 VAC, 50/60Hz,.75A for 5600HV.

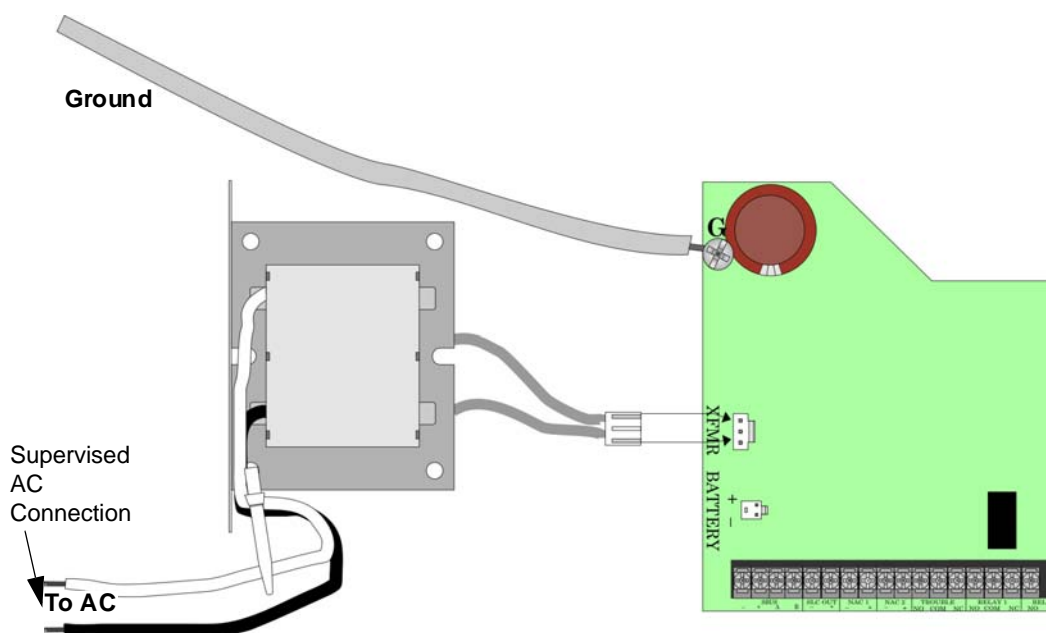

Figure 4-2 120/230 VAC Power Connection

4.3 Battery Connection

The control panel battery charge capacity is 7.0 to 33 AH or 18 AH for ULC installations. The main control cabinet can house batteries up to 7 AH, larger capacity batteries can be housed in a Remote Battery Box (P/N RBB). See Section 4.3.1 for details. Use 12V batteries of the same AH rating. Determine the correct AH rating as per your current load calculation (see Section 3.6). Maximum charging current for batteries is 3.1A @ 27 VDC.

Wire batteries in series to produce a 24-volt equivalent. Do not parallel batteries to increase the AH rating.

The following steps and diagram explain how to connect the batteries.

1. Connect the black wire from the control panel negative (–) battery terminal to the negative (–) side of Battery #2.
2. Connect the jumper wire provided (P/N 140694) from the positive (+) side of Battery #2 to the (–) negative side of Battery #1.
3. Connect the red wire from the control panel positive (+) terminal to the positive (+) side of Battery #1.

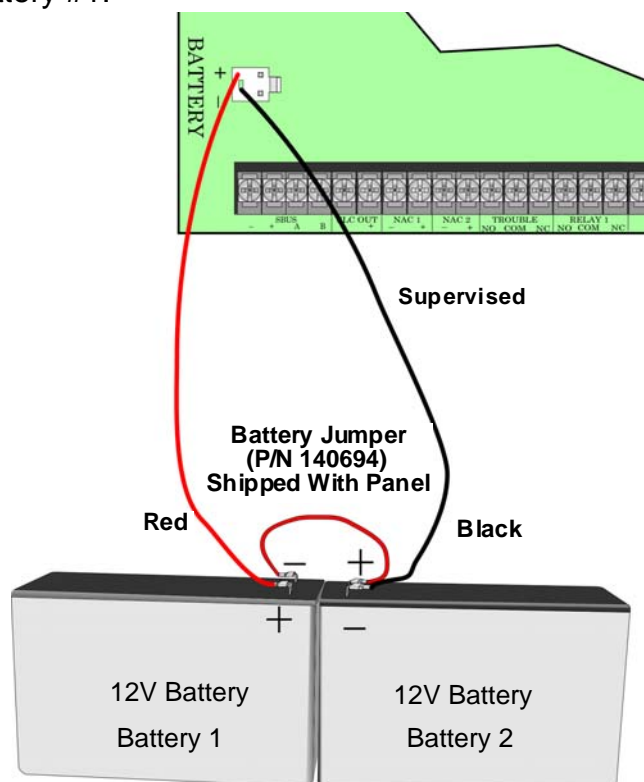

Figure 4-4 Battery Connection

4.3.1 RBB Accessory Cabinet

The Model RBB Accessory cabinet can be used when your backup batteries are too large to fit into the main control panel cabinet. The RBB cabinet holds batteries up to the 35 AH size. The RBB dimensions are 16" W x 10" H x 6" D (40.64 cm W x 25.4 cm H x 15.24 cm D).

4.3.1.1 Installing the RBB Accessory Cabinet and Batteries

To properly install the accessory cabinet and backup batteries, follow these steps:

1. Mount the accessory cabinet. See figure Figure 4-5 for the four cabinet mounting holes.
 - If mounting onto drywall the accessory cabinet must be mounted onto 3/4-inch plywood. This is necessary because the weight of the batteries inside the accessory cabinet could cause the cabinet to pull away from the drywall.
 - When mounting on concrete, especially when moisture is expected, attach a piece of 3/4 inch plywood to the concrete surface and then attach the RBB cabinet to the plywood.
 - If using the battery cable extenders provided (P/N 140643), mount the RBB cabinet no more than 18" away from the main control panel cabinet. This will ensure that the battery cables reach the battery terminals.

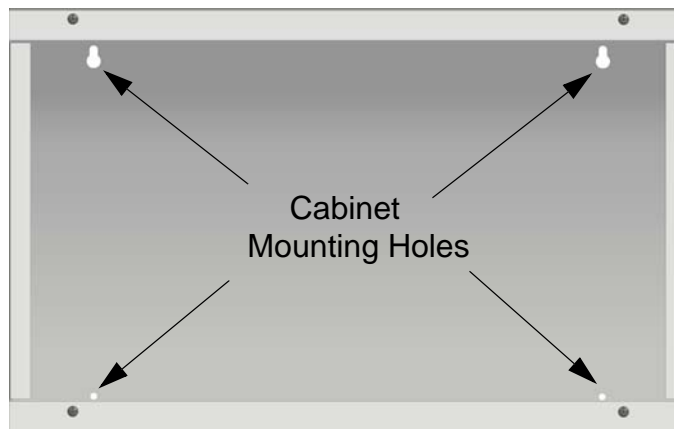

Figure 4-5 RBB Cabinet Mounting Holes

2. Connect the main control panel battery cables to the battery cable extenders as shown in Figure 4-6.

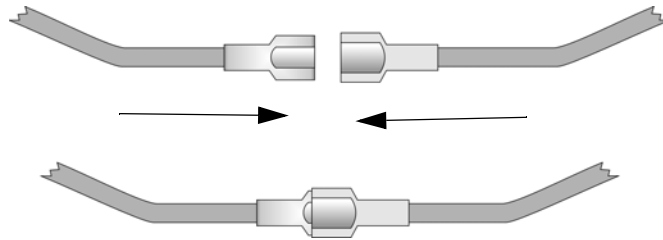

Figure 4-6 Splicing Control panel Battery Cable to RBB Battery Cable Extenders

3. Run extended battery cable from control panel cabinet through conduit to RBB cabinet.
See Figure 4-7.

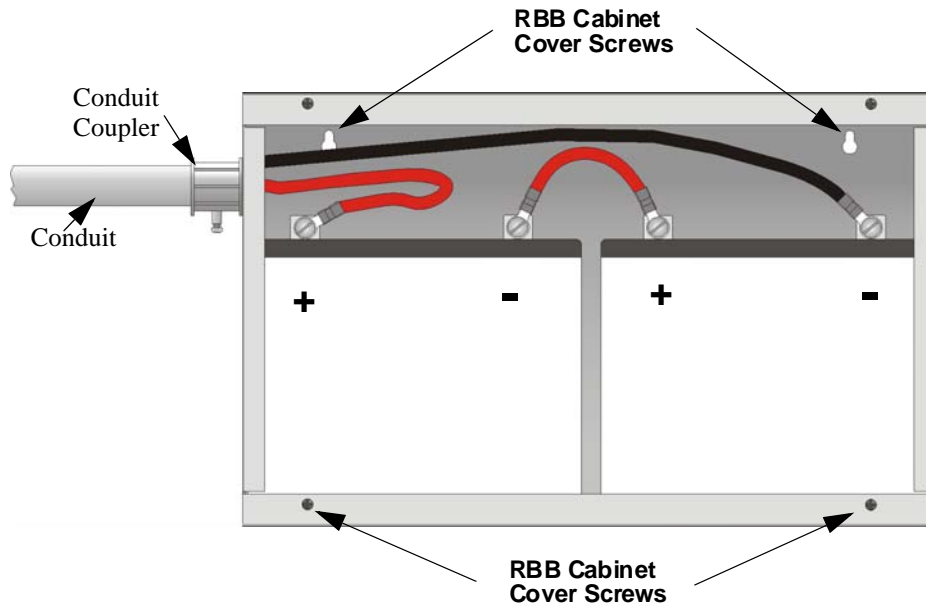

Figure 4-7 Battery Connections in the RBB Cabinet

Note: Figure 4-7 is an example of how the wire connections can be routed. However, any other cabinet knock-outs (on either the main control panel or the RBB cabinet), that are not previously being used may be utilized to connect conduit between the two cabinets.

4. Connect battery leads to the backup battery terminals. See Figure 4-7.
Observe the proper polarity to prevent damage to the batteries or the control panel.
5. Insert the RBB cover screws into the cover mounting holes (see Figure 4-7).
Screw the cover screw $\frac{3}{4}$ of the way into the cover mounting hole.

6. Align the cover plate mounting keyhole over the cover mounting screws. See Figure 4-8.

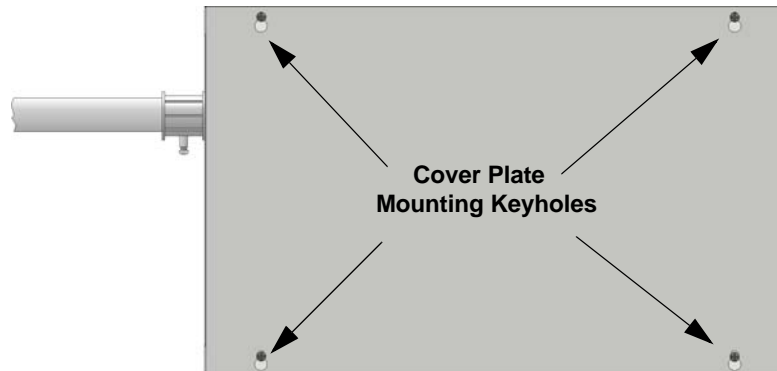

Figure 4-8 Cover Plate Mounting Keyholes and Cover Mounting Screws Alignment

7. Slide the cover into place and tighten the cover mounting screws. See Figure 4-8.

4.4 SBUS Wiring

This section contains information on calculating SBUS wire distances and the types of wiring configurations (Class B).

4.4.1 Calculating Wiring distance for SBUS modules

The following instructions will guide you in determining the type of wire and the maximum wiring distance that can be used with control panel SBUS accessory modules.

To calculate the wire gauge that must be used to connect SBUS modules to the control panel, it is necessary to calculate the total worst case current draw for all modules on a single 4- conductor bus. The total worst case current draw is calculated by adding the individual worst case currents for each module. The individual worst case values are shown in the table below.

Note: Total worst case current draw on a single SBUS cannot exceed 500 mA.

Model Number	Worst Case Current Draw
5635 Remote Fire Annunciator	.04 amps

After calculating the total worst case current draw, Table 4-1 specifies the maximum distance the modules can be located from the panel on a single wire run. The table insures 6.0 volts of line drop maximum. In general, the wire length is limited by resistance, but for heavier wire gauges, capacitance is the limiting factor.

These cases are marked in the chart with an asterisk (*). Maximum length can never be more than 6,000 feet, regardless of gauge used. (The formula used to generate this chart is shown in the note below).

Table 4-1: Wire Distance Per Wire Gauge Using Copper Wire

Wiring Distance: SBUS Modules to Panel				
Total Worst Case Current Draw (amps)	22 Gauge	18 Gauge	16 Gauge	14 Gauge
0.100	1852 ft.	4688 ft.	* 6000 ft.	* 6000 ft.
0.200	926 ft.	2344 ft.	3731 ft.	5906 ft.
0.300	617 ft.	1563 ft.	2488 ft.	3937 ft.
0.400	463 ft.	1172 ft.	1866 ft.	2953 ft.
0.500	370 ft.	938 ft.	1493 ft.	2362 ft.
0.600	309 ft.	781 ft.	1244 ft.	1969 ft.
0.700	265 ft.	670 ft.	1066 ft.	1687 ft.
0.800	231 ft.	586 ft.	933 ft.	1476 ft.
0.900	206 ft.	521 ft.	829 ft.	1312 ft.
1.000 (Max)	185 ft.	469 ft.	746 ft.	1181 ft.

Note: The following formulas were used to generate the wire distance chart:

$$\text{Maximum Resistance (Ohms)} = \frac{6.0 \text{ Volts}}{\text{Total Worst Case Current Draw (amps)}}$$

$$\text{Maximum Wire Length (Feet)} = \frac{\text{Maximum Resistance (Ohms)}}{\text{Rpu}} * 500$$

(6000 feet maximum)

where: Rpu = Ohms per 1000 feet for various wire gauges (see table below)

Table 4-2: Typical Wire Resistance per 1000 ft. using Copper Wire

Wire Gauge	Ohms per 1000 feet (Rpu)
22	16.2
18	6.4
16	4.02
14	2.54

Wiring Distance calculation example:

Suppose a system is configured with the following SBUS modules:

1 - Module 5635 Fire Annunciator

The total worst case current is calculated as follows:

5635 Current Draw	= 1 x .04 amps	= .04 amps
Total Worst Case Current Draw		= .04 amps

Using this value, and referring to the Wiring Distance table, it can be found that the available options are:

1852 feet maximum using 22 Gauge wire

4688 feet maximum using 18 Gauge wire

6000 feet maximum using 16 Gauge wire

6000 feet maximum using 14 Gauge wire

4.4.2 Wiring Configurations

Figure 4-9 illustrates Class B configuration.

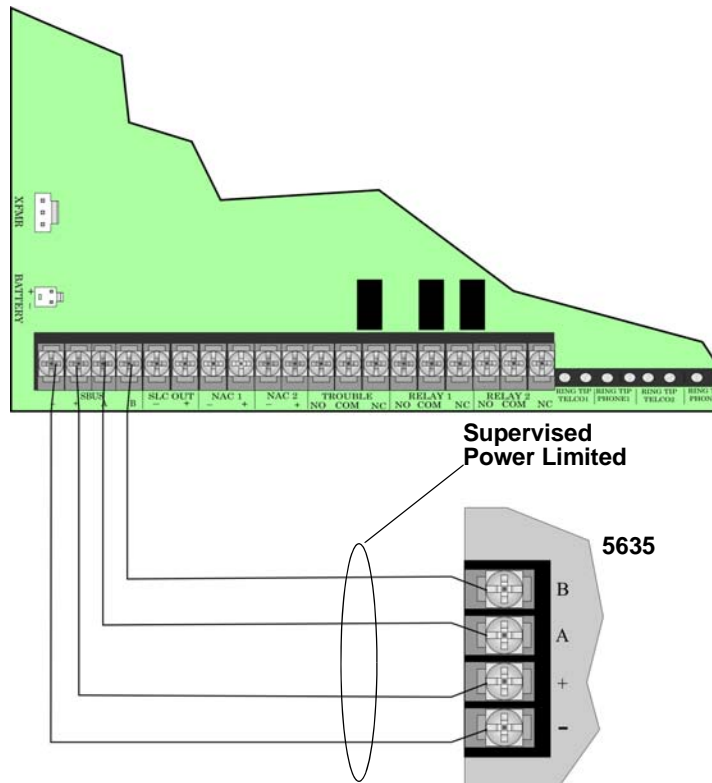

Figure 4-9 SBUS Class B Wiring

4.5 5635 Remote Annunciator Installation

The optional Model 5635R (red) and 5635W (white) Remote Annunciator is shown in Figure 4-10.



Figure 4-10 Model 5635 Remote Annunciator, Front View

5635 installation involves the following steps:

1. Make sure power is off at the panel.
2. Mount the 5635 in the desired location (see Section 4.5.1).
3. Connect the 5635 to the panel (see Section 4.6).
4. Use the DIP switches on the back of the 5635 to assign an ID# to the 5635 (see Section 4.7.1).
5. The new 5635 module must be added to the system through programming. Jump-Start will add the module automatically (see Section 6.4). You can also add it manually (see installation sheet PN 53958).

4.5.1 Mounting the 5635

This section of the manual describes mounting the remote annunciator. Figure 4-11 shows the parts of the annunciator.

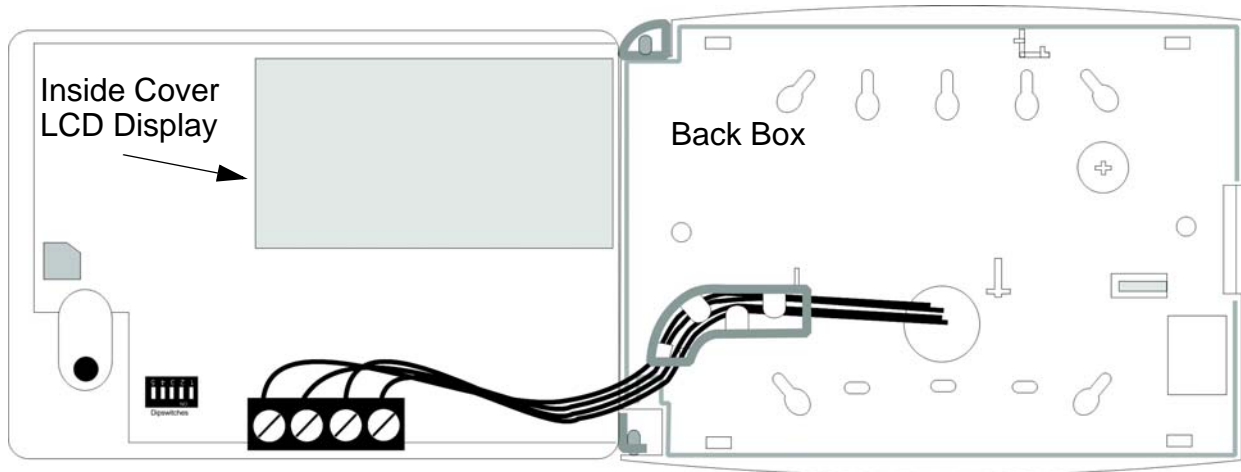

Figure 4-11 5635 Annunciator Parts

The 5635 Series plastic enclosures can be surface or semi-flush mounted in a single, double or 4" square electrical box.

To mount the 5635 Series enclosure:

1. Open the 5635 Series cover by turning the key switch counterclockwise to the ON (Unlocked) position.
2. Push in the snap latch tab located on the right side while pulling the cover open.
3. Pull wire through 7/8" hole in backplate and feed through wire channel to lower left corner of backplate before routing to terminal block.
4. The cover must remain attached to the backplate while mounting the annunciator to the electrical box/ wall. The cover cannot be reattached or removed after the annunciator has been mounted.
5. Surface or Semi-flush mount the 5635 to a single, double or 4" square electrical box. The ANN-SB80KIT(-R/-B/-W) is an available kit that contains two plastic backboxes that can be used to surface mount the 5635.

4.6 Model 5635 Connection to the Panel

Connect the 5635 to the panel as shown in Figure 4-12.

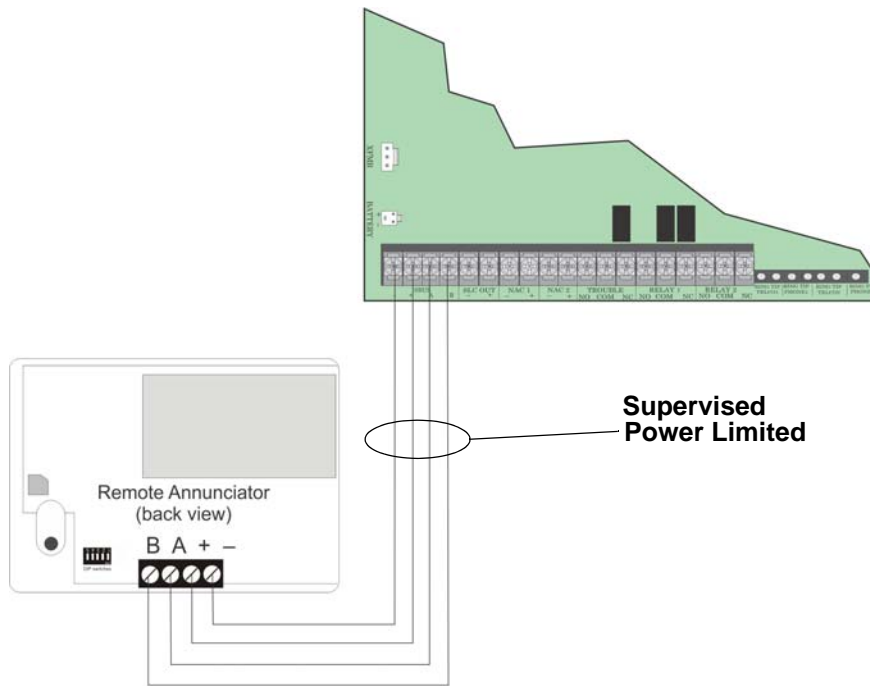

Figure 4-12 Model 5635 Connection to the Panel

4.7 Configuring Module

This section describes how to configure the 5635 Annunciator that has been added to the system. Each SBUS device requires a unique address. 5635 Series DIP switch S21 is used to set the address. This address will be displayed on the LCD display as the Station ID number.

4.7.1 Assigning Module IDs

When installing the 5635 you must use the DIP switches on the module to assign an ID# to the module. A maximum of 2 devices can be connected to the FACP SBUS communication circuit. The SBUS device address needs to be set to 01 or 02.

Note: Note that 00 is not a valid address.

Figure 4-13 shows the DIP switch positions and their correlation to a numerical ID.

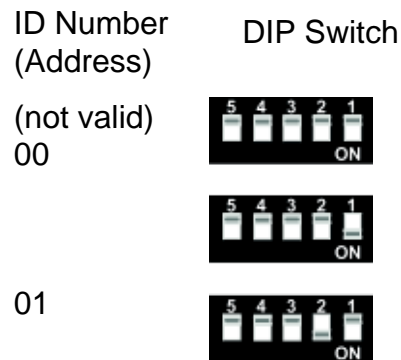

Figure 4-13 DIP switch settings

4.8 Telephone Connection

Connect the telephone lines as shown in Figure 4-14. The Model 7860 phone cord is available from Silent Knight for this purpose.

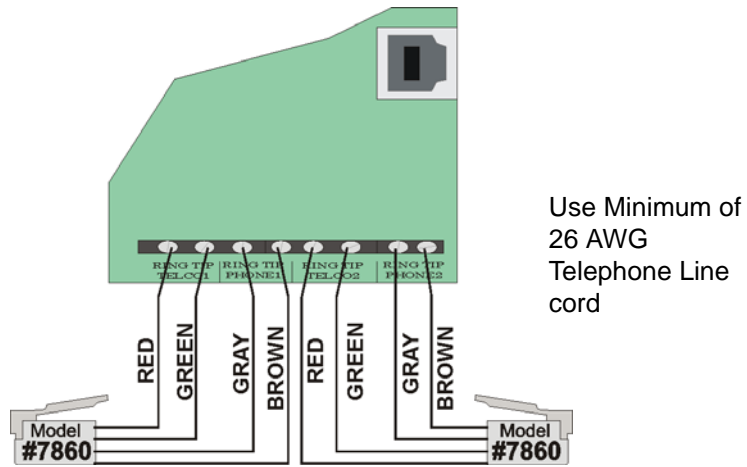

Figure 4-14 Connection of Telephone Lines

4.9 Notification Appliance/Auxiliary Power Circuits

The two outputs of the 5600 FACP can be programmed to be used as NACs or as Aux power.

This section of the manual explains how to install conventional notification appliances and how these terminals can be used for auxiliary power.

4.9.1 Conventional Notification Appliance Circuit

The 5600 supports Class B (Style Y) configurations for notification appliance applications.

You must use an appliance from the list of compatible appliances in the Appendix A at the back of this manual. Each circuit can source up to 2.0A (total current for the system must not exceed 2.0A)

To install a Class B notification appliance circuit:

1. Wire Class B Notification appliances as shown in Figure 4-15.
2. Configure the circuit through programming.

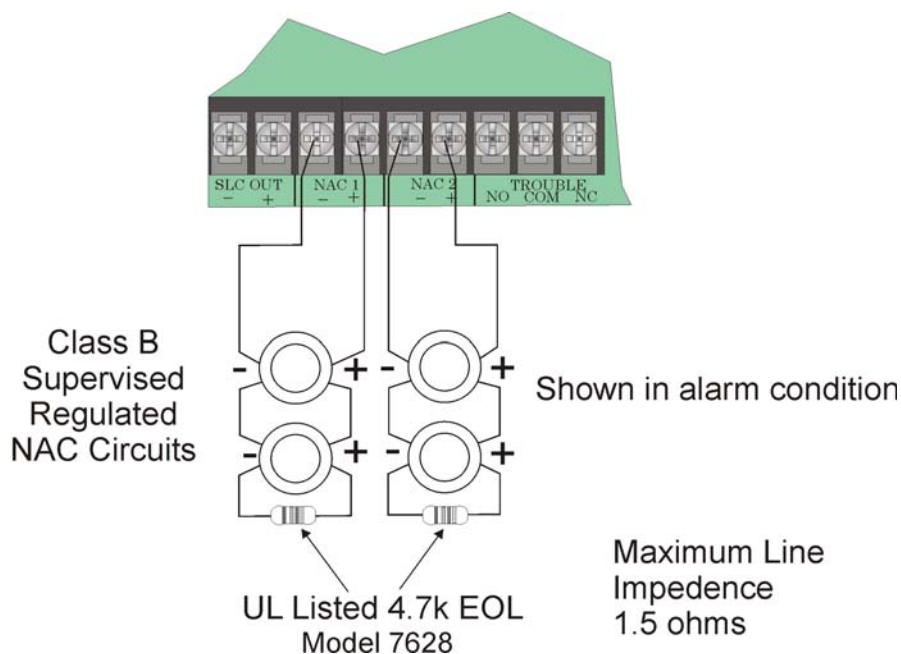

Figure 4-15 Class B Notification Appliance Circuit Wiring

4.9.2 Auxiliary Power Installation

NAC Circuits 1 and 2 on the control panel can be used as auxiliary power circuits. The three types of auxiliary power available are:

- Door Holder (see section 4.9.2.1)
- Constant (see section 4.9.2.2)
- Resettable Power (see section 4.9.2.3)

Auxiliary power circuits are power limited. Each circuit can source up to 1.0A (total current for system must not exceed 2.0A).

To install an auxiliary power circuit:

1. Wire the NAC circuit(s) that will be used for auxiliary power. See 3.5 for location of NAC circuits.
2. Configure the auxiliary power output through programming.

4.9.2.1 Door Holder Power

Door holder power is intended for fire door applications. When there are no alarms in the system and the panel has AC power, door holder circuits have 24 volt power present at their terminals. Any alarm will cause power to disconnect. Power will be re-applied when the system is reset. If AC power is off for more than 15 seconds, the auxiliary door holder power will be disconnected to conserve the battery backup. When AC power is restored, power is immediately restored to the door holder circuits.

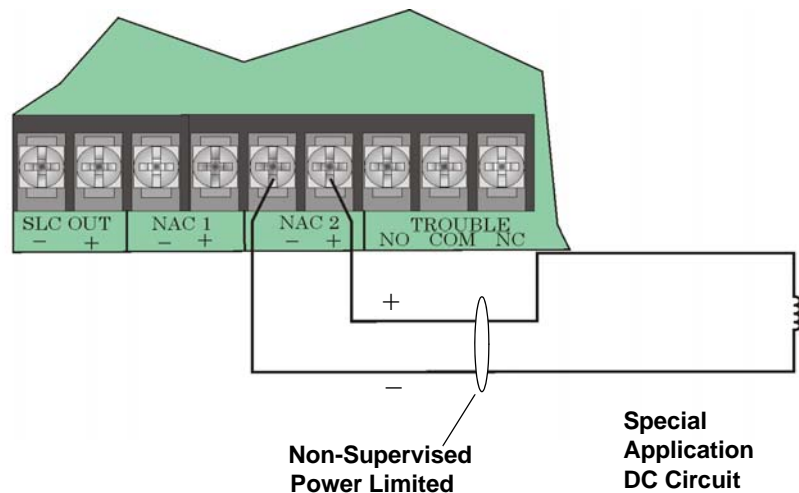

Figure 4-16 Example of an Auxiliary Power For Door Holder

Use a UL listed door holder see list from Appendix A-3, for this application.

4.9.2.2 Constant Power

Use constant power for applications that require a constant auxiliary power source. Power is always present at Constant circuits.

4.9.2.3 Resettable Power

Resettable power is typically used to power beam detectors, flame detectors and conventional 4-wire smoke detectors. For circuits selected as Resettable, 24 volt power is always present at the terminals unless a system reset occurs. If a system reset occurs, power is disconnected from the terminals for 30 seconds, then re-applied.

4.10 On-Board Relays (Conventional, Power Limited)

The control panel has two built-in programmable relays and a built-in trouble relay. All relays are Form C rated at 2.5 A @ 24 VDC Resistive.

4.10.1 Common Trouble Relay

The control panel has a dedicated Form C trouble relay built into terminals labeled TROUBLE. The relay provides a normally open and a normally closed contact. The trouble relay will deactivate under any trouble condition. Form C rated at 2.5 A @ 24 VDC Resistive.

Note: The N.C. contact is the relay contact that is closed when the panel has power and there are no alarm or trouble conditions.

4.10.2 Programmable Relays

The control panel has two Form C programmable relays built into terminals labeled RELAY 1 or RELAY 2. Each relay provides a normally open and a normally closed contact.

To configure one or two programmable relays, follow these steps.

1. Wire Relay 1 and/or Relay 2 as needed for your application. See 4.10.1 for the location of the relay terminals.
2. Default programming causes Relay 1 to activate for any supervisory. Relay 2 will activate for any alarm. For relay applications that require different behavior see Section 6.

4.11 Remote Station Applications

4.11.1 City Box Connection Using the 5220 Module

This section describes how to connect the control panel to a municipal fire alarm box or “city box” as required by NFPA 72 Auxiliary Protected Fire Alarm systems for fire alarm service. The city (master) box is an enclosure that contains a manually operated transmitter used to send an alarm to the municipal communication center which houses the central operating part of the fire alarm system.

City Box Standby Current: 0 (Notification supervision current accounted for in control panel draw.)

Alarm Current: 1 Amp for 1 second

Max Voltage: 24 VDC

The maximum coil and wire resistance (combined) must not exceed 30 ohms.

To install the 5220 for city box connection:

1. Use one of the knockouts on the right side of the control panel to connect the 5220 using a short piece of conduit (must not exceed 20 feet in length).
2. Wire the 5220 to the control panel as shown in Figure 4-17. This drawing also shows how to connect the city box coil to terminals 3 and 4 on the 5220. Do not install an EOL resistor in the terminals of the NAC circuit used for this application.
3. Connect earth ground wire to the 5220 chassis with mounting screw.
4. Program NAC1 as auxiliary and power constant on. Program NAC2 as a non-silencing, constant on notification circuit.

It is not possible to reset the remote indication until you clear the condition and reset the control panel.

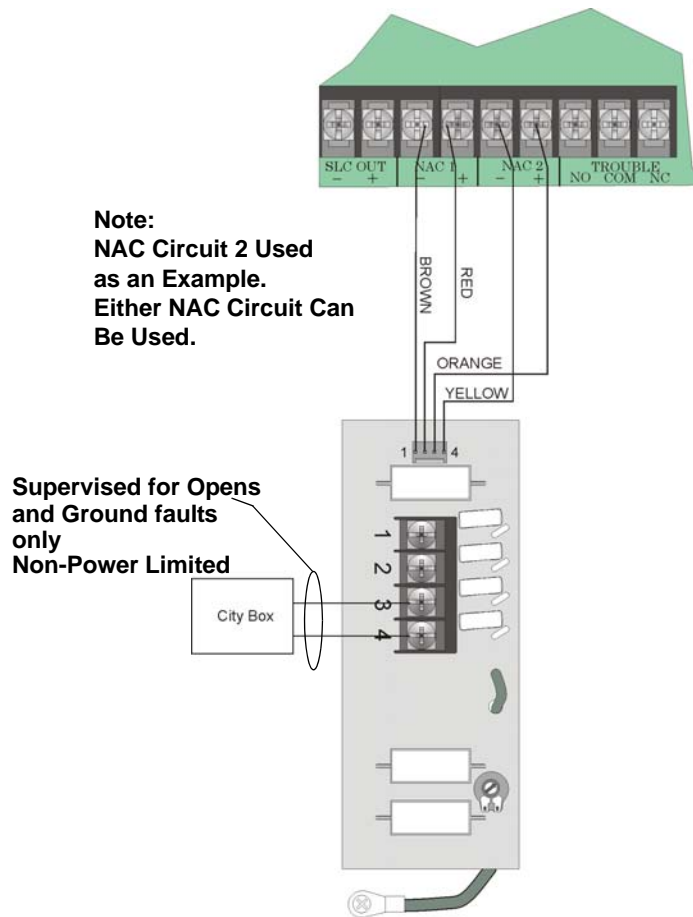
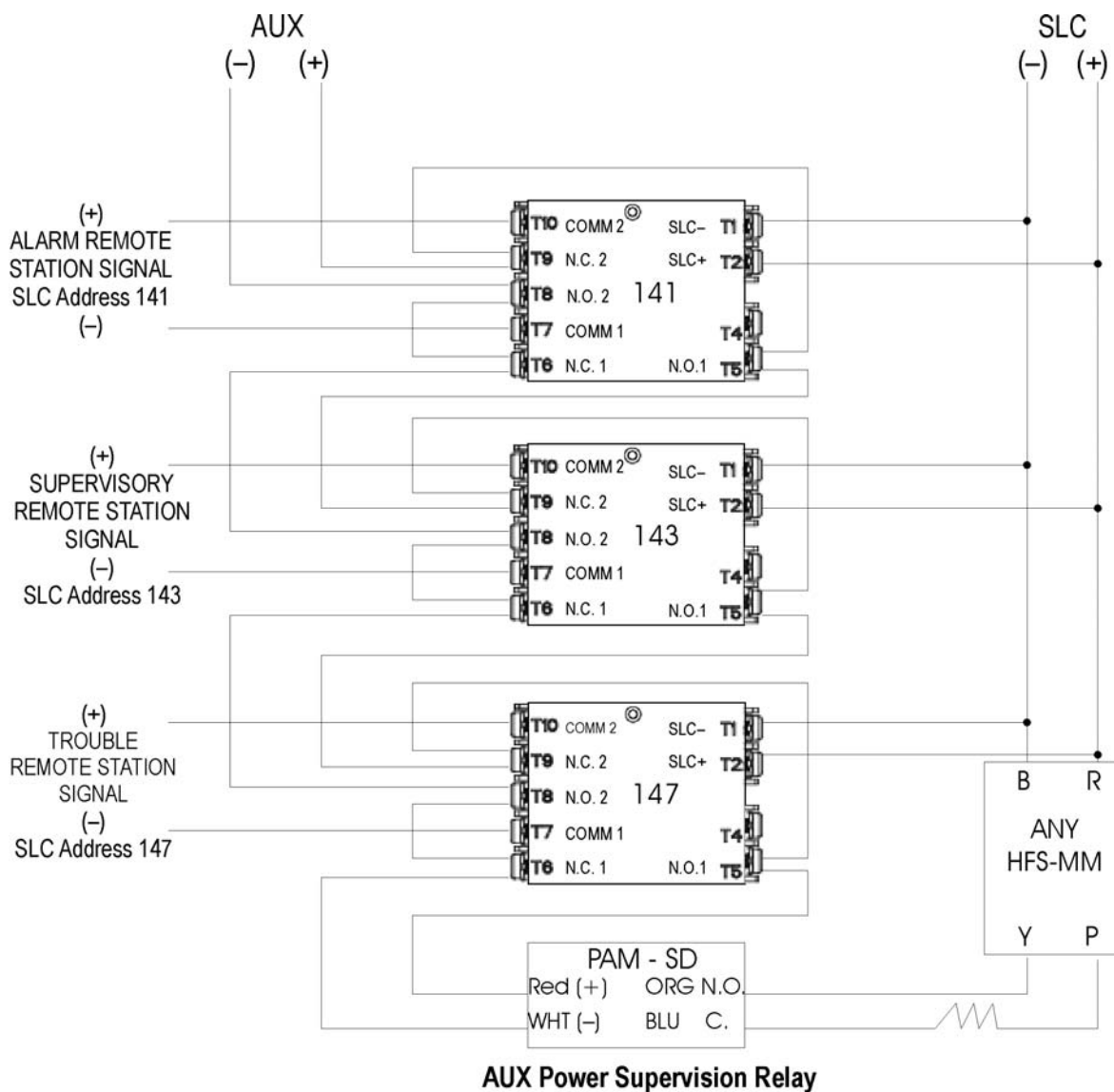

Figure 4-17 City Box Connection

4.11.2 NFPA 72 Polarity Reversal

4.11.2.1 Alarm, Supervisory and Trouble Reverse Polarity Outputs

Three HFS-MR or SK-Relay modules are required to independently report alarm, supervisory and trouble. SLC addresses 141, 143, and 147 must be used as shown in Figure 4-18.



*Must use In/Out wire technique to properly supervise AUX power to all 3 relays

Figure 4-18 Reverse Polarity output wiring

Section 5

SLC Device Installation

Caution!

To avoid the risk of electrical shock and damage to the unit, power should be OFF at the control panel while installing or servicing.

5.1 List of SLC Devices

The following SLC devices can be used with the control panel. See the device installation instructions for more information (packaged with the device).

Part Number	Model Name/Description	Install Sheet PN
HFS-P, HFS-PA, SK-Photo	Photoelectric smoke detector	I56-3483-00, I56-3426-00
HFS-PT, HFS-PTA, SK-Photo-T	Photoelectric smoke detector with thermal (135°F)	
HFS-D, HFS-DA, SK-Duct	Photoelectric duct smoke detector with extended air speed range	I56-3488-00, I56-3432-00
HFS-T, HFS-TA, SK-Heat	Fixed temperature thermal detector (135°F)	I56-3485-00, I56-3429-00
SK-Pull-SA	Addressable single action pull station	I56-3446-001
SK-Pull-DA	Addressable dual action pull station	I56-3347-001
HFS-MM, HFS-MMA, SK-Minimon	Mini monitor module	I56-3487-000, I56-3444-00
HFS-MR, HFS-MRA, SK-Relay	Addressable relay module	I56-3486-000, I56-3438-00
SK-ISO	Addressable Isolator Module	I56-3445-001

5.2 Maximum Number of Devices

- A 5600 system supports a maximum of 25 SLC detectors and modules, in any combination.

5.3 Wiring Requirements for SLC Devices

The following information applies to all SLC devices. Refer to the section that describes the type of device you are installing for details.

5.3.1 Wiring SLC in Style 4 (Class B) Configuration

No special wire is required for addressable loops. The wire can be untwisted, unshielded, solid or stranded as long as it meets the National Electric Code 760-121 requirements for power limited fire protective signaling cables. Wire distances are computed using copper wire.

Maximum wiring resistance is 40 ohms to the farthest SLC device.

Maximum loop length depends on the wire gauge.

All SLC wiring is Supervised, and Power-limited.

Table 5-1: Maximum wiring distance for SLC devices

Wire Gauge	Max. Distance for SLC devices
22 AWG	1200 feet
18 AWG	3100 feet
16 AWG	4900 feet
14 AWG	7900 feet
12 AWG	10,000 feet

The following figures show how length is determined for out and back tap and T-Tap style wiring.

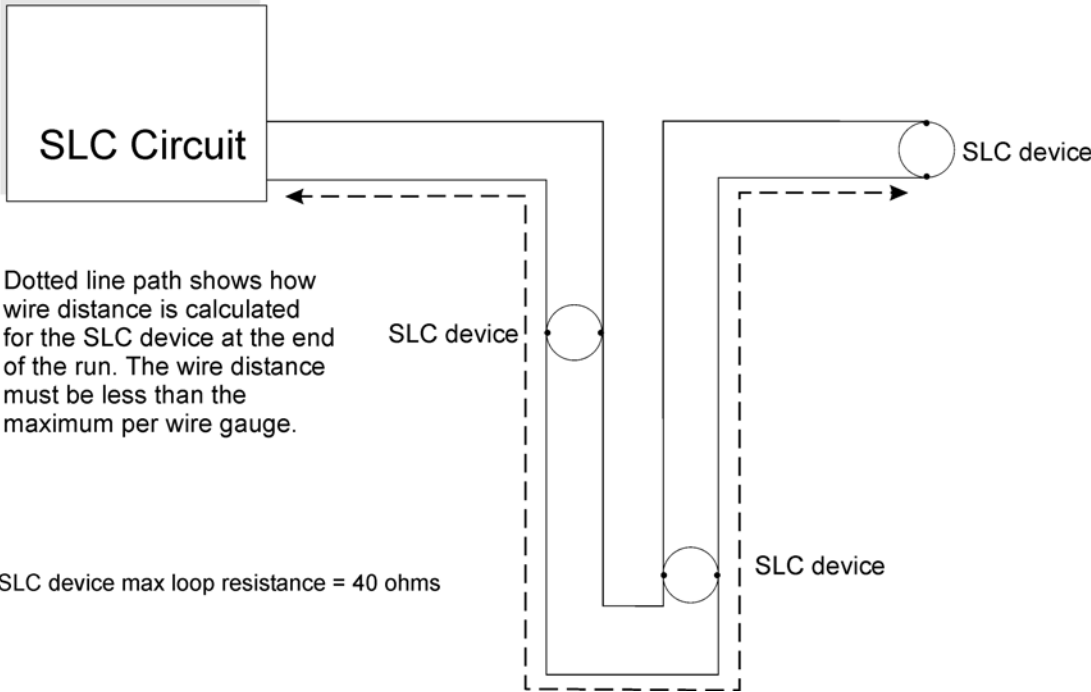
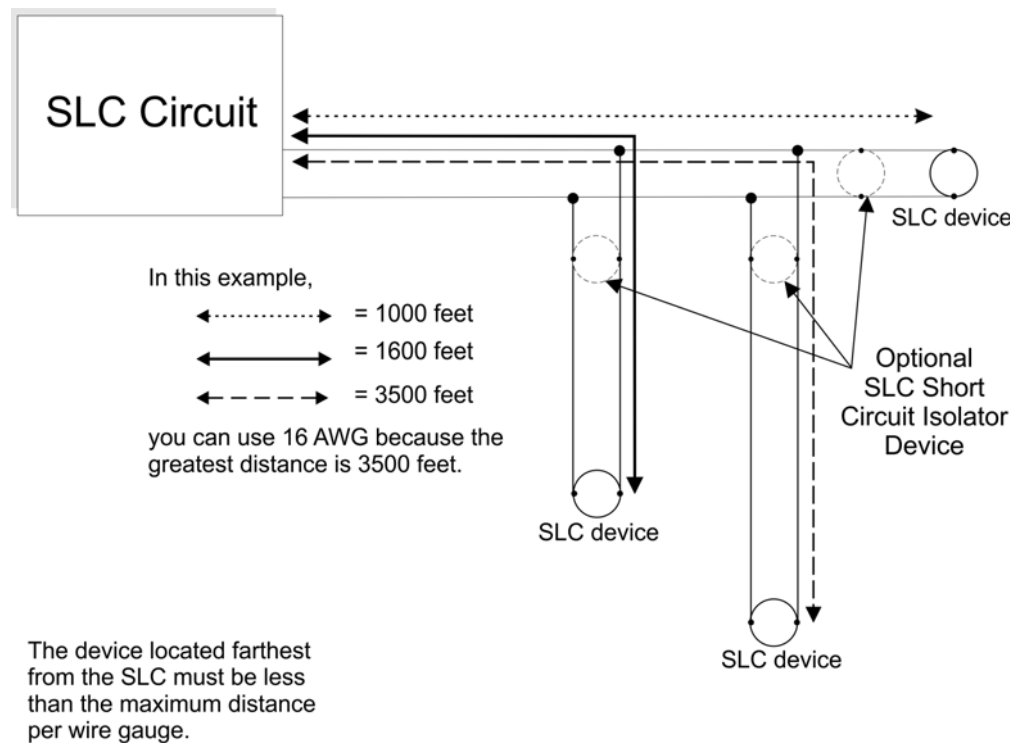

Figure 5-1 Calculating wire run length for a simple out and back

When using T-taps, the total length of all taps and the main bus must not exceed 40,000 feet. This requirement must be met in addition to the maximum distance requirements for the various wire gauges.



SLC device max loop resistance = 40 ohms

Figure 5-2 Calculating Wire Run Length for a T-tap

5.4 Wiring SLC Detectors

This section describes how to install heat and smoke detectors. All detectors ship with installation instructions. Refer to the detector's installation instructions for more detailed information.

This information applies to the following HFS or SK models:

- HFS-P, HFS-PA, SK-Photo - Photoelectric Smoke Detector
- HFS-PT, HFS-PTA, SK-Photo-T - Photoelectric Smoke Detector with Thermal
- HFS-D, HFS-DA, SK-Duct - Photoelectric Duct Detector
- HFS-T, HFS-TA, SK-Heat - Fixed Temperature Detector

To wire HFS or SK detectors:

1. Wire device bases as shown in Figure 5-3.
2. Set the address for each device as described in Section 5.5.

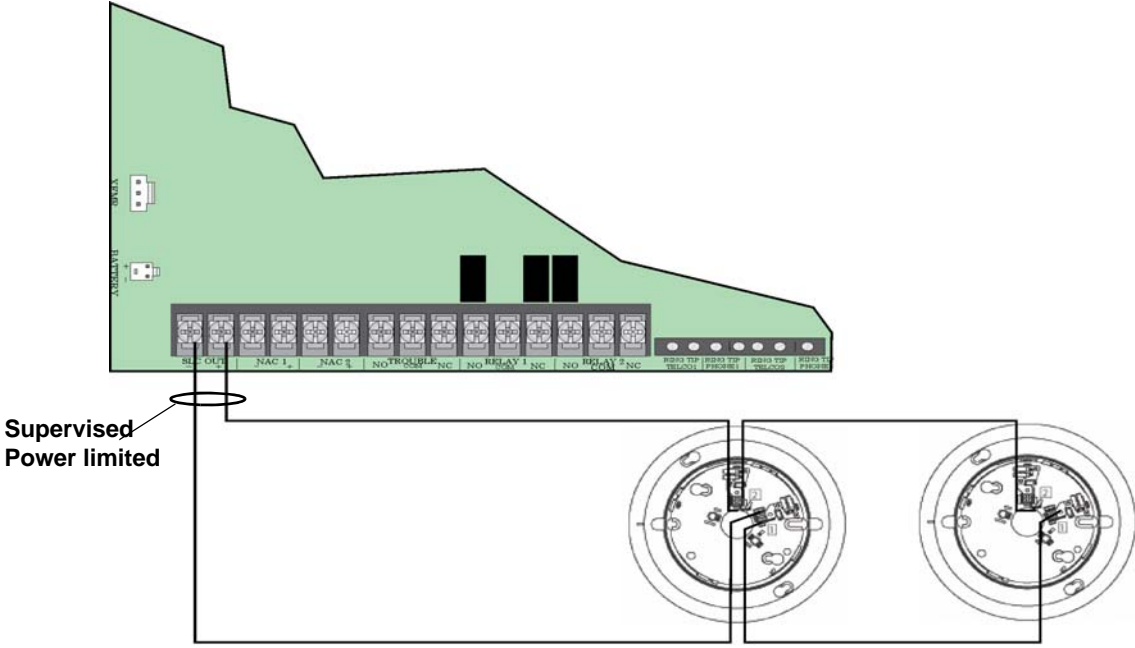

Figure 5-3 Heat and Smoke Detector Connection to the Panel.

5.5 Addressing SLC Devices

All HFS/SK devices are addressed using the two rotary dials that appear on the device board. Use the *ONES* rotary dial to set the ones place in a one or two digit number, and use the *TENS* rotary dial to set the tens place in a two digit number.

Example 1: To select device address 35, turn the *ONES* rotary dial to **5** and the *TENS* rotary dial to **3** as shown in Figure 5-4.

Example 2: To select device address 105, turn the *ONES* rotary dial to **5** and the *TENS* rotary dial to **10** as show in Figure 5-4.

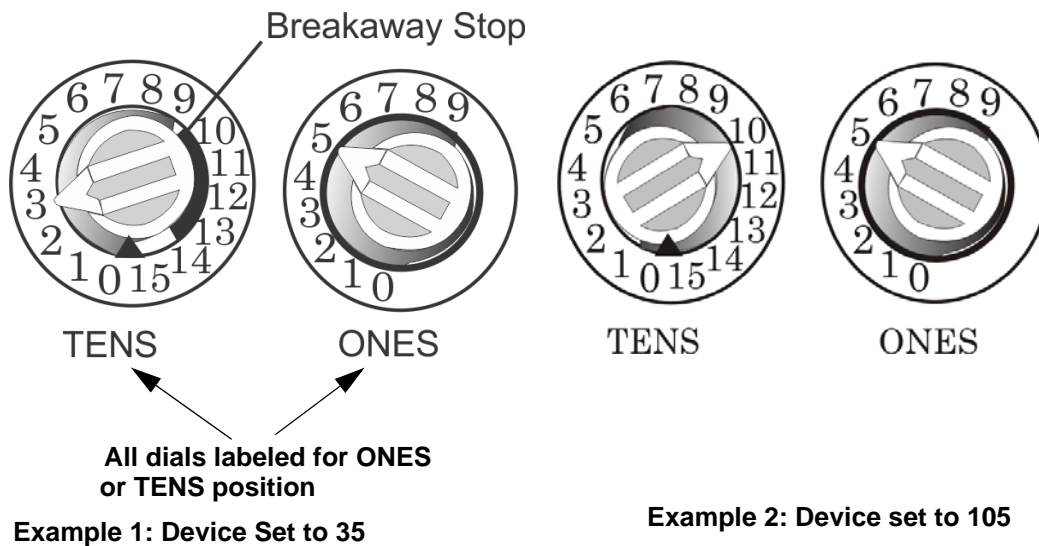

Figure 5-4 HFS/SK SLC Device Addressing Using Rotary Dials

Section 6

Programming

This section of the manual describes how to change the control panel programming options from the built-in web page of the control panel. All options described in this section are edited via the panel's built in web page

Important!

Before any customized programming is done, JumpStart should be run first. After JumpStart is run, thoroughly test the system. The reason the system should be tested after JumpStart is because JumpStart automatically programs the system, searching for and configuring all SLC devices and SBUS annunciators it finds. JumpStart allows you to confirm the integrity of the installation prior to performing any custom programming. After determining that the hardware is properly installed, custom programming can be performed. Refer to Section 6.

6.1 UL 864 Programming Requirements

Table 6-1: Standards in Requirements for Control Units and Accessories

NOTICE TO USERS, INSTALLERS, AUTHORITIES HAVING JURISDICTION, AND OTHER INVOLVED PARTIES: This product incorporates field programmable software. In order for the product to comply with the requirements in the Standard for Control Units and Accessories for Fire Alarm Systems, UL 864, certain programming features or options must be limited to specific values or not used at all as indicated below.

Programming Option	Menu Item	Permitted in UL 864 (Y/N)	Possible Settings	Settings Permitted in UL 864
System Options	Low AC Report Delay	Yes	0-30 hours	1-3
Zone Options	Supervisory	Yes	Latching/Non	Latching
Zone Options	Waterflow	Yes	Latching/Non	Latching
System Options	Alarm Verification	Yes	1-250 seconds	60-250 seconds
Dialer Phone line Programming option	Line Monitor Enabled	Yes	Y/N	Y*

*Only needs to be enabled if using the DACT.

6.2 Control Panel Programming

The 5600 is an addressable control panel that has the characteristics of a 5 zone conventional fire alarm control panel.

6.3 Default Control Panel Configuration.

The panel ships from the factory in a defaulted configuration that may allow the installer to use the panel without doing any custom programming.

6.3.1 Default Mapping of SLC Inputs to Outputs

The panel mapping configuration for the 5600 is fixed with regards to SLC addresses, zone assignments and output points. The relationship between input points and output points follows the rules defined in 6.3.2 below. For input points, the SLC address determines the zone assignment and alarm characteristics. For output points, the SLC address determines the output function for the point.

6.3.2 Mapping of SLC Inputs to Outputs.

Table 6-2: Input Points

INPUT POINTS						
Zone	Input Point Types	Function	Qty	Start SLC ID	End SLC ID	Description
Zone 1	HFS-P, HFS-PT, HFS-D, HFS-T, SK-Photo, SK-Photo-T, SK-Duct, SK-Heat, SK-Pull-SA, SK-Pull-DA, HFS-MM, SK-Minimon	Alarm	15	1	15	Alarm Zone 1
		Supervisory	5	16	20	Supervisory Zone 1
Zone 2	HFS-P, HFS-PT, HFS-D, HFS-T, SK-Photo, SK-Photo-T, SK-Duct, SK-Heat, SK-Pull-SA, SK-Pull-DA, HFS-MM, SK-Minimon	Alarm	15	21	35	Alarm Zone 2
		Supervisory	5	36	40	Supervisory Zone 2
Zone 3	HFS-P, HFS-PT, HFS-D, HFS-T, SK-Photo, SK-Photo-T, SK-Duct, SK-Heat, SK-Pull-SA, SK-Pull-DA, HFS-MM, SK-Minimon	Alarm	15	41	55	Alarm Zone 3
		Supervisory	5	56	60	Supervisory Zone 3
Zone 4	HFS-P, HFS-PT, HFS-D, HFS-T, SK-Photo, SK-Photo-T, SK-Duct, SK-Heat, SK-Pull-SA, SK-Pull-DA, HFS-MM, SK-Minimon	Alarm	15	61	75	Alarm Zone 4
		Supervisory	5	76	80	Supervisory Zone 4
Zone 5	HFS-P, HFS-PT, HFS-D, HFS-T, SK-Photo, SK-Photo-T, SK-Duct, SK-Heat, SK-Pull-SA, SK-Pull-DA, HFS-MM, SK-Minimon	Alarm	15	81	95	Alarm Zone 5
		Supervisory	5	96	100	Supervisory Zone 5

Table 6-3: Output Points

OUTPUT POINTS						
Group	Output Point Type		Qty	Start SLC ID	End SLC ID	Output Activates For
OPG 1	HFS-MR, HFS-MRA, SK-Relay		2	111	112	Zone 1 Alarm
OPG 2	HFS-MR, HFS-MRA, SK-Relay		2	113	114	Zone 2 Alarm
OPG 3	HFS-MR, HFS-MRA, SK-Relay		2	115	116	Zone 3 Alarm
OPG 4	HFS-MR, HFS-MRA, SK-Relay		2	117	118	Zone 4 Alarm
OPG 5	HFS-MR, HFS-MRA, SK-Relay		2	119	120	Zone 5 Alarm
OPG 6	HFS-MR, HFS-MRA, SK-Relay		2	121	122	Zone 1 Supervisory
OPG 7	HFS-MR, HFS-MRA, SK-Relay		2	123	124	Zone 2 Supervisory
OPG 8	HFS-MR, HFS-MRA, SK-Relay		2	125	126	Zone 3 Supervisory
OPG 9	HFS-MR, HFS-MRA, SK-Relay		2	127	128	Zone 4 Supervisory
OPG 10	HFS-MR, HFS-MRA, SK-Relay		2	129	130	Zone 5 Supervisory
OPG 11	HFS-MR, HFS-MRA, SK-Relay		2	131	132	Zone 1 Trouble
OPG 12	HFS-MR, HFS-MRA, SK-Relay		2	133	134	Zone 2 Trouble
OPG 13	HFS-MR, HFS-MRA, SK-Relay		2	135	136	Zone 3 Trouble
OPG 14	HFS-MR, HFS-MRA, SK-Relay		2	137	138	Zone 4 Trouble
OPG 15	HFS-MR, HFS-MRA, SK-Relay		2	139	140	Zone 5 Trouble
OPG 16	HFS-MR, HFS-MRA, SK-Relay		2	141	142	General Alarm
OPG 17	HFS-MR, HFS-MRA, SK-Relay		2	143	144	General Supervisory
OPG 18	HFS-MR, HFS-MRA, SK-Relay		2	145	146	General Zone Trouble
OPG 19	HFS-MR, HFS-MRA, SK-Relay		2	147	148	General Trouble
OPG 20	HFS-MR, HFS-MRA, SK-Relay		2	149	150	Alarm Silenced
OPG 21	HFS-MR, HFS-MRA, SK-Relay		2	151	152	Trouble Silenced
OPG 22	HFS-MR, HFS-MRA, SK-Relay		2	153	154	AC Loss
OPG 23	HFS-MR, HFS-MRA, SK-Relay		2	155	156	Resettable Aux Relay
OPG 24	HFS-MR, HFS-MRA, SK-Relay		2	157	158	Aux Door Holder

Table 6-2: shows that any input SLC device with an address set within the range 1-15 will be assigned to zone 1 as an alarm input type. An SLC output relay point assigned to address 111 or 112 will activate for an alarm in zone 1.

6.3.3 Default Mapping for the 2 built-in Notification Circuits.

There are 2 built-in notification circuits (NAC 1 and NAC 2). They are both defaulted to activate when any of the 5 zones are in alarm. When active, NAC 1 and NAC 2 will sound the System Sensor synchronization pattern. To change the behavior of the default mapping of these circuits refer to Section 6.5.

6.3.4 Maximum SLC address point count

The 5600 control panel supports a maximum of 25 SLC points to be used within the 159 point address range. The points can be all inputs, all outputs or any combination of inputs and output points. When more than 25 SLC devices are added to the control panel, any excess points will indicate a trouble and not be recognized by the panel.

6.3.5 Installer Code

The installer code is factory programmed as 123456. The installer code is required to learn and remember which SLC devices are connected to the panel. The installer code can be changed when a PC is used to modify the default programming options.

6.4 JumpStart AutoProgramming

Once the physical installation of SLC devices is finished, the panel will need to learn which SLC devices and SBUS annunciators are present.

IMPORTANT

There is no limit to how often you can run JumpStart. Each time you run this process it starts fresh and does not remember previously installed devices that are no longer present.

To run JumpStart:

1. Press and hold the “JumpStart” key,
2. Press the installer code after PIN is displayed.
3. During JumpStart, the panel will briefly light up all LEDs and then display “SLC Prg” on the 7 segment display.
4. When complete the display will be off and programming is complete.

If changes are required that affect address settings for the SLC devices, device types or number of SLC devices installed you will need to repeat JumpStart to re-learn which devices are supposed to be present on the system.

6.5 Modifying Panel Programming using a PC

6.5.1 Connecting the panel to a PC

Modifications to the default panel programming can only be done using the embedded web server of the control panel. There are two ways to connect to the panel for the purpose of programming. It can be connected through a DHCP (Dynamic Host Configuration Protocol) router or it can also be plugged in using a Standard CAT5e Ethernet cable without a router. Both methods of connecting the panel to the PC are for local connection only.

By default, the panel is configured to search for a DHCP server. If there is a DHCP server present, the panel receives the IP configuration offered by the DHCP server and displays the IP address on the seven segment display.

If the panel is connected to a PC without a router, it assigns itself a default class B IP address of the format (169.254.X.X). Each panel will have a unique IP address and it will also be displayed on the 7 segment display. When direct connected, it will normally take about 40 seconds to display the IP address. The panel displays "IP" while the IP address is being determined during this 40 second search period.

A PC with the Windows operating system may take up to 1 minute to fallback to the APIPA (Automatic Private IP Addressing) which enables the PC to communicate to the panel. Whether using either the PC direct connect or the PC connected to the panel via DHCP router, you are ready to view and edit the panel programming options once the panel shows the IP address on the seven segment display.

The embedded web page programming tool is accessed by typing in the panel IP address in a web browser. MS Internet explorer 6 and Mozilla Firefox 3.0.5 are the only two web browsers tested and recommended.

6.6 Panel Programming Options

All customized programming options for the 5600 control panel are described in this section and are available to be edited using the embedded web server of the control panel.

6.6.1 System Options

6.6.1.1 Synchronized Strobes Active When Horns Silenced

The default configuration for this option is No. If set to Yes, strobes will remain on when horns are silenced until a panel reset is issued.

6.6.1.2 Silence/Reset Inhibit Enabled

The default configuration for this option is NO. If set to Yes, Pressing either Reset or Silence Buttons will be ignored for the duration of the delay (set to 30 seconds). The inhibit feature delay is only active for the first alarm/supervisory signal.

6.6.1.3 Water Flow Delay

The water flow delay is a debounce time that is generally used to help reduce false alarms during brief periods of water pressure fluctuation in a water riser. The default setting is 1 second which is the minimum debounce time. You can set the water flow delay within the range 1-90 seconds.

6.6.1.4 Installer Code (User ID)

This is the password used to lock the list of SLC devices found during the JumpStart auto learn process. It is defaulted to 123456 and can be changed to any 4 to 8 digit number.

6.6.1.5 Alarm Verification Time

Alarm verification is an optional false alarm prevention feature for smoke detectors that verifies an alarm condition by resetting the smoke detector. The alarm verification time can be set within the range of 1-250 seconds. For UL 864 installations this option must be greater than 59 seconds. The default setting is 60 seconds.

6.6.1.6 Auto Test

Enter the hour/minutes (in 24 hour format) that you desire the control panel to send the automatic test report.

6.6.1.7 Low AC Report Delay

This option determines the number of delay hours before a loss of AC is reported to

the central station. It is defaulted to 3 hours and must be within the range 0-30 hours. For U.L. 864 installation this option must be set within the range 1-3 hours.

6.6.1.8 Walk Test Reporting

The default configuration for this option is No. If set to Yes, the panel generates a TEST report to the central station when the walk test begins. During a walk test, the panel's normal fire alarm function is completely disabled, placing the panel in a local trouble condition. All zones respond as 1-Count zones (respond when a single detector is in alarm) during a walk test. Each alarm initiated during the walk test will be reported.

6.6.1.9 Walk Test duration

Enter the amount of time, in minutes, for the walk test duration. When the programmed amount of time expires, the Walk Test will end automatically.

6.6.1.10 Walk Test NAC Time out

Enter the amount of time, in seconds, for the walk test NAC active duration. During a walk test alarm activation, the NACs will automatically deactivate after the programmed amount of time expires.

6.6.1.11 Clock Source

The panel's AC line frequency is selectable for 60 Hz, 50 Hz, or Internal Clock Source. AC frequency feature dictates how the control panel will calculate time based on the AC line frequency used in the installation site. The "Internal Clock" option can be used in areas where the AC line frequency is not dependable and you want the panel to calculate time from the internal crystal. The internal crystal is not as accurate as the AC power source. The panel defaults to the 60 HZ selection.

6.6.1.12 Auto Daylight Savings Time

Select this feature to "Yes" if you want the panel to automatically adjust the clock to track with daylight savings time.

6.6.1.13 Remote Annunciator

Select this feature to "Yes" if a 5635 Remote Annunciator is to be used. A customized banner can also be added to the Remote Annunciator. The Remote Annunciator allows for the top 2 lines to be programmed as a custom banner.

6.6.2 Zone Programming

6.6.2.1 SLC Addresses Within Each Zone

Each zone has 15 alarm SLC addresses and 5 supervisory SLC addresses assigned to it as described in table 6.1. For each SLC address within a zone, the SLC device type choices are Unused, Detector, Manual Pull Switch, Latching Water Flow Switch or Non-Latching Water Flow Switch. The default setting is that all points are unused.

6.6.2.2 Zone Silenceable

When an alarm occurs within a zone, there is a programming option that allows the outputs to be silenceable or not. If you want the SILENCE key to be able to silence outputs triggered by active alarms within the zone select YES for this option. The default setting is Yes.

6.6.2.3 Zone Type

A zone can be either a one count zone or an alarm verification zone. The default setting is one count. A one count zone has an immediate alarm when a single detector goes into alarm.

Alarm verification is an optional false alarm prevention feature for smoke detectors that verifies an alarm condition by resetting the smoke detector. If the alarm condition still exists by the time the reset cycle has completed, the detector will go into alarm. If the detector is no longer in alarm, the initial alarm is ignored. The alarm verification sequence for a detector does not occur if the zone is already in alarm.

6.6.3 Output Point Programming

For each output SLC address you can select that a device is present or unused. The default setting for all output points is unused.

6.6.4 Notification Appliance Circuit (NAC) Programming

6.6.4.1 Circuit Function

The two notification circuits are both defaulted to activate the System Sensor synchronization pattern when any of the five zones are in alarm. You can define each of the notification circuits to be either a conventional notification circuit or an auxiliary power type circuit.

6.6.4.2 Conventional Notification Circuit Mapping

When defined as a conventional notification circuit, the circuit can be configured to activate for any combination of zone alarms and/or supervisories. Select all the categories you wish to have the circuit activate under.

Conventional Notification Circuit Cadence Pattern

When a conventional notification circuit activates, it can be configured to produce one of six output patterns.

1. Constant On - 24V DC power
2. ANSI - ANSI temporal pattern
3. AMSECO Sync - Strobe synchronization for AMSECO appliances
4. Gentex Sync - Strobe synchronization for Gentex appliances
5. System Sensor Sync - Strobe synchronization for System Sensor appliances
6. Wheelock Sync - Strobe synchronization for Wheelock appliances

Auxiliary Power Options

Each of the notification circuits can be configured as an auxiliary power circuit in one of three options.

1. Constant - Always on, 24V DC power.
2. Door Holder - 24V DC when in standby, Off if any alarm device activates, or loss of AC power.
3. Resettable - 24V DC except for 30 seconds off during panel reset.

6.6.5 Relay Programming Options

The two on-board relays of the control panel can be programmed for Auxiliary Resettable and Auxiliary Door Holder applications. Relay 1 can be selected to activate for General Supervisory. Relay 2 can be selected to activate for General Alarm. See Figure 6-1.



Figure 6-1 Relay Programming Option

6.6.5.1 General System Relay Silence Option

This option defaults to silenceable. This option controls the silencing behavior for Relay 1, Relay 2 and the general output relays at SLC addresses 141 through 148.

6.6.6 Dialer Phone Line Programming Options

The programming options below are available for each of the two phone lines.

6.6.6.1 Line Prefix

This option allows the insertion of digits, delays and special tone characters to be dialed before the phone number stored in the account option is dialed. The default setting is to not have any prefix.

6.6.6.2 Dial Tone Detection

The default configuration for this option is "Enabled". If set to "Disabled", the dialer will not check for the presence of dial tone on the associated phone line prior to making a call.

6.6.6.3 Line Monitoring Enabled (Y/N)

This option is used to enable phone line voltage supervision. It defaults to No.

6.6.6.4 Dialing Option

The dialer can use touch tone or pulse dialing when calling the central station. The options for dialing are touch tone only, dial pulse only or alternating touch tone/dial pulse when multiple attempts are used to connect with the central station. The default setting is touch tone only.

6.6.6.5 Pulse Dialing Format

There are two duty cycle options for the pulse dialing. US format is 60/40. European format is 66/34. The default setting is the US format.

6.6.7 Dialer Account programming Options

Up to two accounts can be used for reporting events to the central station. A typical reason to use multiple reporting accounts might be to have one account for reporting alarms and a different account for reporting supervisories and troubles. The programming options for each account are described below.

6.6.7.1 Account Number

Up to six digits allowed for SIA formats or up to four digits for contact ID format. Default account numbers are blank.

6.6.7.2 Phone Number

Enter the phone number to call the central station. Default setting is blank.

The following special characters are available:

Table 6-4:: Special Dialing Characters

#	Pound (or number) key on the telephone
*	Star key on the telephone
,	Comma (character for 2-second pause)

6.6.7.3 Reporting Format

Choose SIA8 (up to 8 events per call), SIA20 (up to 20 events per call) or contact ID reporting format. Default setting is contact ID.

6.6.7.4 Reporting Filters

Selecting the Must option forces the event type to be reported to the account even if it was already reported to another account. Selecting the Yes option will insure that the event type gets to at least one account. Selecting the No option means that the event type will not be reported to this account. The default setting is No.

Selecting No for all report filters in both accounts effectively disables the dialer.

Section 7

System Operation

The operation of the 5600 control panel is similar to a conventional 5 zone Fire Alarm Control Panel. System status and control is segmented into zones even though the panel supports addressable SLC devices for input and output functions.

Note: ULC version of the panel (5600C) has a built in Alarm Reset and Alarm Silence inhibit of 30 seconds

7.1 System Reset

To reset the system press the RESET key once. All LEDs will light while the system is being reset. Alarms and Supervisories that were latched will be reset to their normal state. Outputs that had been activated by any Alarms and Supervisories will be deactivated.

7.2 Lamp Test

For Lamp test in accordance with ULC-527-99, see 5600C Basic Operating Instructions.

7.3 System Silence

To Silence the PZT and all silenceable outputs that are active, press the SILENCE key once. Any silenceable trouble, supervisory or alarm that is silenced will automatically unsilence if left silenced for 24 hours or if a new trouble, supervisory or alarm event occurs.

7.4 Acknowledge

Use the ACK key to acknowledge alarm, supervisory and trouble events

7.5 Viewing Active Alarm Points

When one or more SLC points within a zone are in alarm, the alarm LED for that zone will blink and outputs will activate that are mapped to alarms within the zone. To display the SLC address of an input point that is in alarm, press the ALARM ID key once and use the PREV (previous) or NEXT key to scroll through the alarm points. All points that are in alarm spanning all zones on the control panel will be displayed when using the scroll keys.

7.6 Viewing Active Supervisory Points

When one or more SLC points within a zone are in supervisory alarm, the supervisory LED for that zone will blink and outputs will activate that are mapped to supervisories within the zone. To display the SLC address of an input point that is in supervisory, press the SUPERVS ID key once and use the PREV (previous) or NEXT key to scroll through the supervisory points. All points that are in supervisory spanning all zones on the control panel will be displayed when using the scroll keys.

7.7 Viewing Active Trouble Points

When one or more SLC points within a zone are in trouble, the trouble LED for that zone will blink and outputs will activate that are mapped to troubles within the zone. To display the SLC address of an input point that is in trouble, press the TROUBLE ID key once and use the PREV (previous) or NEXT key to scroll through the trouble points. All addressable points that are in trouble throughout the control panel will be displayed when using the scroll keys.

Note: If there are any system level troubles active, the LED corresponding to the system level trouble will blink also. However, system level troubles are not displayed on the 7 segment display after using the TROUBLE ID key and the PREV or NEXT to scroll addressable troubles. Only point troubles are displayed.

7.8 Walk Test

Walk test is enabled by holding the WALK TEST key until the PZT stops. This takes about 5 seconds. Once in walk test the 7 segment display will show that the walk test is active. During walk test, inputs can be activated and the outputs that are mapped to the input will be activated for 3 seconds. The input will automatically be reset when the outputs are deactivated.

The exit walk test, hold the WALK TEST key until the PZT stops. The panel is now in normal standby mode.

7.9 Fire Drill

A fire drill is activated by holding the DRILL key until the 7 segment display shows drl on. All outputs will be active. To stop the fire drill, press the RESET key. If the reset key is not pressed within 10 minutes, the fire drill will automatically reset.

7.10 Zone Disable Feature

To disable a zone, press the disable zone key that corresponds to the zone number you wish to disable. When a zone is disabled all alarm events that occur while the zone is disabled will be ignored. Zones that are disabled will be in trouble. The PZT will sound the trouble cadence. The trouble LED for the specific zone along with the general trouble LED will blink indicating that the zone is in trouble. If the silence key is pressed after a zone is disabled, the trouble LEDs will be continuously on and the PZT will silence.

To enable a zone which had been previously disabled, press the disable zone key that corresponds to the zone number you wish to enable. Each pressing of the zone disable key will toggle the disable/enable state for the zone.

Note: Followed by the Installers code in ULC installations. See Basic Operating Instructions.

7.11 Disabling Notification Circuits

There are 2 notification circuits on the 5600 control panel (NAC1 and NAC2). You can disable them individually by pressing the NAC1 or NAC2 disable keys. A disabled notification circuit will cause a trouble on the circuit. The PZT will sound the trouble cadence. The trouble LED for the circuit along with the general trouble LED will blink indicating trouble. If the silence key is pressed, the trouble LEDs will be continuously on and the PZT will silence.

Pressing the NAC disable key when the circuit is already disabled will enable the circuit. Each pressing of a NAC disable key will toggle the disable/enable state for the circuit.

7.12 Loss of AC power

When AC is present and above the brown out threshold, the AC LED will be on continuously. When AC power is off or below the brown out threshold, the AC LED will blink. The GENERAL TROUBLE LED will blink also. The trouble relay will activate for loss of AC once the reporting delay for reporting loss of AC power has been reached. The default setting for this delay is 3 hours. If the silence key is pressed, the trouble LEDs will be continuously on and the PZT will silence.

7.13 Remote Connection Feature (ULC Installations Only)

To disconnect the communication paths to the Central Station and/or remote stations, press the walk test button and the Acknowledge button at the same time. The PZT on the panel will sound and the General Trouble LED will be flashing. This feature will remain active until you press the Walk Test and Acknowledge buttons again.

7.14 Low Battery

The battery voltage is continuously monitored during normal standby. When the battery is not present or the voltage is too low, the control panel will indicate a low battery trouble. Both the LOW BATTERY and GENERAL TROUBLE LED will blink when there is a low battery condition. The PZT will also sound the trouble cadence. If the silence key is pressed, the trouble LEDs will be continuously on and the PZT will silence.

7.15 Ground Fault

The control panel monitors the SLC and notification circuits for wiring shorts to earth ground. If any wire from these circuits is connected to earth ground the control panel will indicate a ground fault by blinking both the GROUND FAULT and GENERAL TROUBLE LED. The PZT will also sound the trouble cadence. If the silence key is pressed, the trouble LEDs will be continuously on and the PZT will silence.

7.16 Phone Line Monitoring

The control panel monitors the phone line voltage at TELCO1 and TELCO2 when line monitoring is enabled (see programming section 6.5.6.3). When line monitoring is enabled and there is not sufficient voltage at TELCO1 or TELCO2, the 7 segment display will indicate “Ln1” and/or “Ln2” for phone line 1 and phone line 2 troubles.

7.17 Reporting Account Monitoring

When the control panel is configured to use the dialer, the reporting accounts will indicate trouble if the panel has failed to communicate to the central station after 10 attempts. Account 1 trouble is indicated on the 7 segment display as “AC1”. Account 2 trouble is indicated on the 7 segment display as “AC2”. Once the communication path to the central station is restored, the account troubles will self restore.

7.18 SLC Fault

In the event that the SLC circuit is shorted or drawing too much current, the panel will indicate this by displaying “SLC err” on the 7 segment display. Remove the fault and the trouble will self restore.

7.19 Dialer Error

In the event that the dialer microprocessor is unable to communicate with the main microprocessor the panel will indicate this by displaying “dlr” on the 7 segment display. If this trouble is ever displayed, the panel needs to be returned to the factory for repair.

7.20 Annunciator Description

Operation of the Remote Annunciator is simple. See 5635 Installation instructions PN 53958 for more information. Figure 7-1: shows the Remote Annunciator.

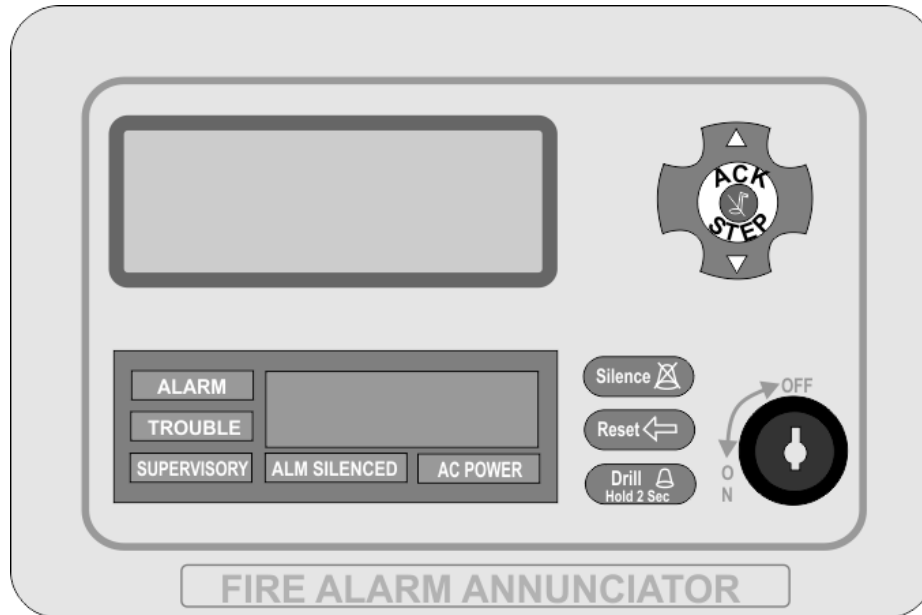

Figure 7-1: 5635 Remote Annunciator

7.20.1 LCD Displays

The Remote Annunciator's LCD displays system messages, annunciates alarms, supervisories and troubles; provides status information; and prompts for input. These messages can be up to 80 characters, displaying over four lines of 20 characters each. Annunciator keys beep when they are pressed.

7.20.2 Banner

The banner is the message that displays on the Annunciator when the system is in normal mode (no alarm, trouble or supervisory condition exists). You can create a customized message that will display instead of the internal (default) message. See 6.6.1.13 for information on customizing the banner.

Text of Internal Banner

```
Honeywell Fire  
Systems  
ALL SYSTEMS NORMAL  
2/10/11 02:41:58 PM
```

Custom Banner example

```
ABC Company  
Fire System  
ALL SYSTEMS NORMAL  
2/10/11 02:41:58 PM
```

Figure 7-2: Banner Display Examples

7.21 Basic Operation

7.21.1 Conduct a Fire Drill

1. Activate the key by turning it to the ON position.
2. Press and hold the Drill key for 2 seconds.
3. The drill will begin after the key has been held down for 2 seconds.
4. Press the Reset key to end the Fire Drill. (If you do not press the Reset Key to end the Fire Drill manually, it will time out automatically after 10 minutes.)

7.21.2 Conduct an Indicator Test

The indicator test checks the annunciator LEDs, PZT, and LCD display.

1. Activate the key by turning it to the ON position.
2. Press the Reset Key to conduct an indicator test. The system turns on all LEDs for several seconds, beeps the PZT, and displays a message on the LCD display. A problem is indicated if any of the following occurs:
 - An LED does not turn on
 - You do not hear the beep
 - The LCD is unable to annunciate the message correctly

7.21.3 Silence alarms or troubles

1. Activate the key by turning it to the ON position.
2. Press the Silence Key.

Note: Alarm and trouble signals that have been silenced but the detector remains un-restored and will un-silence every 24 hours until it is restored.

7.21.4 Reset alarms

1. Activate the key by turning it to the ON position.
2. Press the Reset key.

7.21.5 View Alarms or Troubles

When the system is in alarm or trouble, you can press the Down key to view the location of an alarm or trouble. The Point ID, and time stamp of when the condition occurred will also be displayed.

7.22 Operation Mode Behavior

The remote annunciator can be in one of six conditions at any given moment: Normal, Alarm, Supervisory, Trouble, Silenced, and Reset. Table 7-1 describes the behavior of the Remote Annunciator in each of these modes.

Table 7-1: Operation Modes of Remote Annunciator



Operation Mode	Occurs When	System Behavior	In This Mode You Can
Normal	No alarm or trouble condition exists.	<p>AC POWER LED is on.</p> <p>The All Systems Normal display indicates that the system is in normal mode.</p>  <p>The current date and time display on the last line of the LCD.</p>	
Alarm	A smoke detector goes into alarm or a pull station is activated.	<p>The dialer seizes control of the phone line and calls the central station.</p> <p>The Remote Annunciator sounds a loud, steady beep (any notification devices attached to the system will also sound).</p> <p>ALARM LED flashes.</p> <p>The LCD displays a screen similar to this one.</p> 	<p>Press the down arrow to view the alarm. A screen similar to this one displays.</p>  <p>Activate the key by turning it to the ON position then press the Silence key to silence the Remote Annunciator (and any notification devices attached to the system).</p> <p>When the alarm condition clears, activate the key and press Reset to restore the panel to normal.</p>
Supervisory	The system detects a supervisory condition.	<p>The dialer seizes control of the phone line and calls the central station.</p> <p>The Remote Annunciator sounds a loud, pulsing beep in the sequence one second on, one second off.</p> <p>SUPERVISORY LED flashes.</p> <p>The LCD displays a screen similar to this one.</p> <p>The LCD displays a screen similar to this one.</p> 	<p>Press down arrow to view the supervisory condition. A screen similar to this one displays.</p>  <p>Activate the key by turning it to the ON position then press the Silence key to silence the Remote Annunciator.</p> <p>Once the supervisory condition has been corrected, the system will restore itself automatically.</p>

Table 7-1: Operation Modes of Remote Annunciator

Operation Mode	Occurs When	System Behavior	In This Mode You Can
Trouble	A system trouble condition occurs.	<p>The dialer seizes control of the phone line and calls the central station.</p> <p>The remote annunciator sounds a loud, pulsing beep in the sequence one second on, nine seconds off.</p> <p>TRouble LED flashes.</p> <p>The LCD displays a screen similar to this one.</p> 	<p>Press down arrow to view the trouble. A screen similar to this one displays.</p>  <p>Activate the key by turning it to the ON position then press the Silence key to silence the Remote Annunciator.</p> <p>Once the trouble condition has been fixed, the system will restore itself automatically.</p>
Reset	The  button is pressed while the key is activated.	All LEDs are on briefly then the LCD displays "RESET IN PROGRESS". If the reset process completes normally, the date and time normal mode screen displays.	
Silenced	An alarm or trouble condition has been silenced but still exists. To silence alarms and troubles, press  while the key is activated.	SILENCE LED is on. TROUBLE, SUPERVISORY or GENERAL ALARM LED (depending on condition) is on. The annunciator (and any notification devices attached to the system) will be silenced.	Press down arrow to view the location of the alarm or trouble. When the condition no longer exists, the SYSTEM SILENCED and SYSTEM TROUBLE LED, SUPERVISORY or GENERAL ALARM LEDs turn off.

Section 8

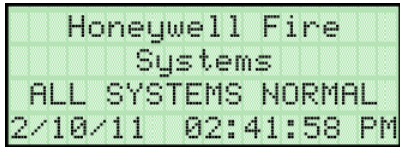
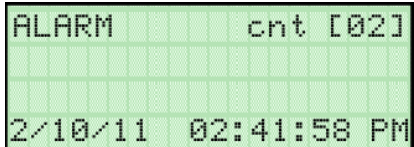
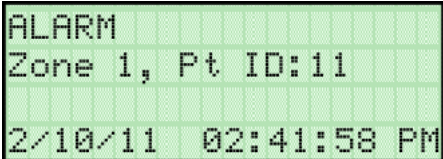
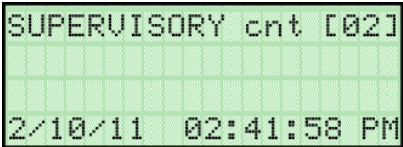
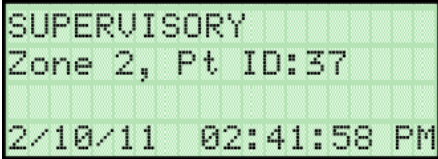
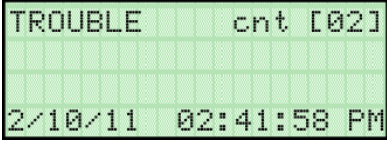
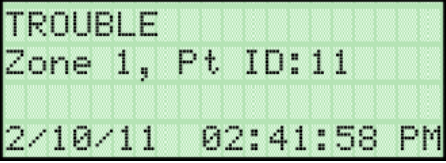
Reporting

This section lists receivers that are compatible with this control panel, and the reporting codes sent by the control panel for SIA and Contact ID formats.

8.1 Receivers Compatible with the Control Panel

Table 8-1 shows receivers compatible with the control panel.

Table 8-1: Receivers Compatible with the Control Panel

Manufacturer	Model	Format
Silent Knight	Model 9800	SIA and Contact ID
	Model 9000 (SIA formats)	SIA
Ademco	Model MX8000 (Contact ID)	Contact ID
Sur-Gard	SG-MLR2-DG (V. 1.64 or higher)	SIA and Contact ID
Osborne Hoffman	Quickalert	SIA and Contact ID

8.2 Reporting Formats Dialer Outputs

Event Description	Event Family	Event Class (System, Zone, or Point)	SIA Reporting Format			Contact ID Reporting Format			
			Module ID # (if any)	SIA Event Code	Parameter (if any)	Qualifier	Event Code	Group #	Contact #
System Events									
System events are reported when either "Report by Zone" is selected.									
AC power restore	Trouble	System Event		AR		3	301	00	000
AC power lost	Trouble	System Event		AT		1	301	00	000
Short circuit removed from SLC communication loop	Trouble	System Event		ER	33	3	332	00	Exp. ID
Short circuit detected on SLC communication loop	Trouble	System Event		ET	33	1	332	00	Exp. ID
Fire drill has begun	Test	System Event		FI		1	604	00	000
Fire drill ended	Test	System Event		FK		3	604	00	000
Panel date has been changed	Trouble	System Event		JD		1	625	00	000
Panel time has been changed	Trouble	System Event		JT		1	625	00	000
Local programming begin	Trouble	System Event		LB		1	627	00	000

Model 5600 Installation and Operation Manual

Phone line 1 trouble restore	Trouble	System Event		LR	1	3	351	00	001
Phone line 2 trouble restore	Trouble	System Event		LR	2	3	352	00	002
Phone line 1 trouble detected	Trouble	System Event		LT	1	1	351	00	001
Phone line 2 trouble detected	Trouble	System Event		LT	2	1	352	00	002
Periodic test event – normal	Test	System Event		RP		1	602	00	000
Periodic test event – off normal	Test	System Event		RY		1	608	00	000
Initial power up	Trouble	System Event		RR		1	305	00	000
Unable to report to an account	Trouble	System Event		RT	Acct #	1	354	Acct #	Acct #
User has initiated dialer test	Test	System Event		RX		1	601	00	
Walk test end	Test	System Event		TE		3	607	00	000
Walk test begin	Test	System Event		TS		1	607	00	000
Auto dialer test communication trouble	Trouble	System Event		YC	Line #	1	350	00	Line #
Report to an account successful	Trouble	System Event		YK	Acct #	3	354	Acct #	Acct #
Auto dialer test communication trouble restore	Trouble	System Event		YK	Line #	3	350	00	Line #
Ground fault condition detected	Trouble	System Event		YP	34	1	310	00	Exp. ID
Ground fault condition restore	Trouble	System Event		YQ	34	3	310	00	Exp. ID
Battery voltage restore	Trouble	System Event		YR	34	3	302	00	Exp. ID
Battery voltage low	Trouble	System Event		YT	34	1	302	00	Exp. ID
Zone Events	Zone events are reported only when “Report by Zone” is selected.								
Manual pull switch alarm	Alarm	Zone Event		FA	Zone	1	115	00	Zone
Detector alarm	Alarm	Zone Event		FA	Zone	1	110	00	Zone
Manual pull switch alarm restore	Restore	Zone Event		FH	Zone	3	115	00	Zone
Detector alarm restore	Restore	Zone Event		FH	Zone	3	110	00	Zone
Manual pull switch trouble restore	Trouble	Zone Event		FJ	Zone	3	373	00	Zone
Detector trouble restore	Trouble	Zone Event		FJ	Zone	3	373	00	Zone
Auxiliary power trouble restore	Trouble	Zone Event		FJ	0000	3	320	00	000
Notification output trouble restore	Trouble	Zone Event		FJ	1000+ Group #	3	320	00	Group #

Manual pull switch trouble	Trouble	Zone Event		FT	Zone	1	373	00	Zone
Detector trouble	Trouble	Zone Event		FT	Zone	1	373	00	Zone
Auxiliary power trouble	Trouble	Zone Event		FT	0000	1	320	00	000
Notification trouble	Trouble	Zone Event		FT	1000+ Group#	1	320	00	Group #
User initiated a system reset	Reset	Zone Event		OR		1	401	00	000
Water flow switch alarm	Alarm	Zone Event		SA	Zone	1	113	00	Zone
Water flow switch alarm restore	Restore	Zone Event		SH	Zone	3	113	00	Zone
Water flow switch trouble restore	Trouble	Zone Event		SJ	Zone	3	373	00	Zone
Supervisory/Tamper switch trouble restore	Trouble	Zone Event		SJ	Zone	3	373	00	Zone
Supervisory condition restore	Trouble	Zone Event		SR	Zone	3	203	00	Zone
Supervisory condition	Trouble	Zone Event		SS	Zone	1	203	00	Zone
Water flow switch trouble	Trouble	Zone Event		ST	Zone	1	373	00	Zone
Supervisory/Tamper switch trouble	Trouble	Zone Event		ST	Zone	1	373	00	Zone

Section 9

Trouble Shooting and Quick Tips

9.1 Troubleshooting

This section of the manual offers suggestions for troubleshooting hardware problems. Please read this section if you encounter a problem when installing the control panel. If these suggestions do not solve your problem or if you encounter a problem that is not listed here, contact Silent Knight Technical Support for assistance.

9.1.1 JumpStart

Jumpstart will learn all of the SLC devices and SBUS annunciators attached to the system. Do a JumpStart first and any customization second.

1. Press and hold the JumpStart key until "PIN" is displayed
2. Enter the installers code on the 10 digit keypad
3. "SLC" "Prg" will be displayed until the JumpStart is complete

9.1.2 View Active Points

View Active Points (alarm, non-system trouble, and supervisory conditions)

Press the corresponding ID key (e.g. Alarm ID)

Use Prev and Next to view more active points of that type

9.1.3 Disable Or Re-Enable A Zone

1. Press the Zone x Disable button on the keypad
2. The PZT will sound a trouble

Can be silenced by pressing Signal Silence (ALL points in that zone are affected)

9.1.4 Silence the Board PZT

Press ACK

9.1.5 Silence the Notification Appliances

1. Press SIGNAL SILENCE

2. If Silence/Reset Inhibit Enabled is selected in programming, that button and the SYSTEM RESET button are ignored for the first 30 seconds of the first alarm or supervisory signal

9.1.6 To Initiate a Fire Drill

1. Press Drill until "DRL" is displayed
2. Press SYSTEM RESET to end the drill

9.1.7 For a Dialer Test

Press JumpStart and Next at the same time

9.1.8 For a Lamp Test

Press JumpStart and Prev at the same time

9.1.9 AC LED

The AC LED will blink for the loss of AC and the Trouble Relay will activate after the programmed delay time (default = 3 hours).

9.1.10 Walk Test

1. Press and hold Walk Test for about 5 seconds to start a walk test
2. Press SYSTEM RESET to end the test

9.1.11 Seven Segment Display

On the 7 segment display:

"**AC1**" indicates dialer account 1 failed to report

"**AC2**" indicates dialer account 2 failed to report

"**dlr**" indicates a problem with the dialer. The panel must be returned to the factory for repair

"**drL**" indicates a fire drill is taking place

"**Ln1**" indicates low/no voltage on phone line 1

"**Ln2**" indicates low/no voltage on phone line 2

"**CE1**" indicates Autotest Comm Error Line 1

"**CE2**" indicates Autotest Comm Error Line 2

"**SLC err**" indicates an over current condition on the SLC loop

"**bAt**" indicates battery trouble

“**rA1**” indicates remote annunciator 1 trouble

“**rA2**” indicates remote annunciator 2 trouble

“**gnd**” indicates ground fault trouble

“**AC**” indicates AC power supply trouble

“**nC1**” indicates notification appliance circuit 1 trouble

“**nC2**” indicates notification appliance circuit 2 trouble

“**tSt**” indicates a trouble for the duration of a walk test

Correct the fault and the trouble will restore

9.2 Web Server Menus

The System Summary and Mapping Table sections are not editable, but are populated based on the entries in the other sections.

9.2.1 To add a smoke detector:

Which zone will it be in (e.g. the Lunchroom, Zone 2)?

1. Click on Zone Programming, under Zone 2
2. Click Alarm Points
3. Find an Unused SLC Address and click on the detector type (e.g. address 24 Photo)
4. Click Accept

Note: Remember to choose to Download to Panel after all of your changes are done AND set the rotary switches on the back of the smoke detector (e.g. tens=2 and ones=4)

9.2.2 To add a notification appliance (fire bell)

1. Click on NAC Programming
2. Click on the NAC circuit you want to activate (e.g. NAC 1)
3. Click to check the box for either Alarm and/or Supervisory events to cause that NAC to activate.

9.2.3 To add a Remote Annunciator (DIP switch address 1 or 2)

1. Click on System Options

2. Click on yes option for Remote Annunciator Installed 1/ Remote Annunciator Installed 2
3. Click Accept

Note: Remember to choose to Download to Panel after all of your changes are done

9.2.4 To add custom Zone name

1. Click on Zone Programming
2. Click on Zone Options. Enter custom Zone name (20 characters max) in the corresponding field
3. Click Accept

Note: Remember to choose to Download to Panel after all of your changes are done

9.2.5 To trip an SLC notification appliance

1. Click on Output Point Programming
2. Click on the tab for the event type you want to activate the notification appliance
3. Click the circle for Present across from one or both of the SLC device(s) addresses for the Zone which has the initiation devices that you want to trip the appliance

Note: Be sure to set your SLC notification device address to match

9.2.6 To trip a Door Holder

1. Click on Output Point Programming
2. Click on the System tab
3. Click on the circle for Present across from the SLC Address of the door holder (e.g. 158)
4. Set the Door Holder device address accordingly (e.g. 158)

The Door Holder will provide 24VDC when in standby, 0V during alarms or loss of AC. An on board relay can also be used for Door Holder power. See Section 6.6.5.

Help to reduce false alarms

In the System Options section, Water Flow Delay can be adjusted to account for brief periods of water pressure fluctuation

Alarm Verification Time verifies an alarm condition by resetting the smoke detectors before activating alarms (U.L. 864 installations must not exceed 60 seconds).

Appendix A

Compatible Devices

A.1 Notification Appliances

For proper operation, you must use polarized devices with a Model 7628 4.7k ohm EOL resistor on each loop. All supervised notification appliances used with the control panel must be polarized.

Note: Not all devices can use the Sync feature, be sure to check Table A-1 to ensure the device you have chosen will work with this feature. This control is UL listed for panel wide Synchronization.

Table A-1 below lists notification appliances compatible with the fire alarm control panel. Appliances which can be synchronized indicate the type of SYNC available in the columns marked Audio and/or Visual.

Table A-1 Compatible Notification Appliances

Manufacturer	Model	Audio	Visual	Type
AMSECO	SH24W-153075	X	X	Horn/Strobe
	SAD24-153075		X	Strobe
	SAD24-75110		X	Strobe
	SL24W-75110		X	Strobe
	SL24C-3075110		X	Strobe
	SLB24-75		X	Strobe
	RSD24-153075		X	Strobe
	RSD24-75110		X	Strobe
	SH24W-75110	X	X	Horn/Strobe
	SH24W-3075110	X	X	Horn/Strobe
	SHB24-75	X	X	Horn/Strobe
	SCM24W-153075	X		Chimes/Strobe
	SCM24W-75110	X		Chimes/Strobe
	SCM24C-3075110	X		Chimes/Strobe
	SCM24C-177	X		Chimes/Strobe
	H24W	X		Horn
	H24R	X		Horn

Manufacturer	Model	Audio	Visual	Type
Gentex	GEC-24-15	X	X	Horn/Strobes
	GEC-24-30	X	X	Horn/Strobes
	GEC-24-60	X	X	Horn/Strobes
	GEC-24-75	X	X	Horn/Strobes
	GEC-24-177	X	X	Horn/Strobes
	GEC-24-110	X	X	Horn/Strobe
	GEC-24-15/75	X	X	Horn/Strobe
	GX91	X		MiniHorn Steady Tone
	GX93	X		MiniHorn Temporal Tone
	HG124			Horn
	HS24-15	X	X	Horn/Strobe
	HS24-30	X	X	Horn/Strobe
	HS24-60	X	X	Horn/Strobe
	HS24-75	X	X	Horn/Strobe
	HS24-110	X	X	Horn/Strobe
	HS24-1575	X	X	Horn/Strobe
	GCC24	X	X	Multi Candela Horn/Strobe Ceiling Mount
	GCCR24	X	X	Multi Candela Horn/Strobe Ceiling Mount
	GCS24		X	Multi Candela Strobe Ceiling Mount
	GCSR24		X	Multi Candela Strobe Ceiling Mount
	GEER-24	X	X	Multi Candela Horn/Strobe
	GES24-15		X	Strobes
	GES24-30		X	Strobes
	GES24-60		X	Strobes
	GES24-75		X	Strobes
	GES24-110		X	Strobes
	GES24-15/75		X	Strobes
	GES24-177		X	Strobes
	GES3-24		X	Multi Candela Strobe
	GESR-24		X	Multi Candela Strobe
	GEH-24	X		Horn
	ST24-30		X	Strobe
	ST24-60		X	Strobe
	ST24-75		X	Strobe
	ST24-110		X	Strobe
	ST24-1575		X	Strobe
	WGEC24-75W	X	X	Weatherproof Horn/Strobe
	WGES24-75W		X	Weatherproof Strobe
	WGMS-24-X			Horn/Strobe

Manufacturer	Model	Audio	Visual	Type
System Sensor	CHR	X		Chime
	CHW	X		Chime
	CHSR	X	X	2-Wire Chime/Strobe
	CHSW	X	X	2-Wire Chime/Strobe
	HR	X	X	Horn
	HW		X	Horn
	HRK		X	Horn
	P2R	X	X	2-Wire Horn/Strobe
	P2R-P	X	X	2-Wire Horn/Strobe
	PC2R	X	X	2-Wire Horn/Strobe
	PC2R-P	X	X	2-Wire Horn/Strobe
	P2RH	X	X	2-Wire Horn/Strobe High Candela
	P2RH-P	X	X	2-Wire Horn/Strobe High Candela
	PC2RH	X	X	2-Wire Horn/Strobe High Candela
	PC2RH-P	X	X	2-Wire Horn/Strobe High Candela
	P2W	X	X	2-Wire Horn/Strobe
	P2W-P	X	X	2-Wire Horn/Strobe
	PC2W	X	X	2-Wire Horn/Strobe
	PC2W-P	X	X	2-Wire Horn/Strobe
	P2WH	X	X	2-Wire Horn/Strobe High Candela
	P2WH-P	X	X	2-Wire Horn/Strobe High Candela
	PC2WH	X	X	2-Wire Horn/Strobe High Candela
	PC2WH-P	X	X	2-Wire Horn/Strobe High Candela
	P2RK	X	X	2-Wire Horn/Strobe
	PC2RK	X	X	2-Wire Horn/Strobe
	P2RHK	X	X	2-Wire Horn/Strobe High Candela
	PC2RHK	X	X	2-Wire Horn/Strobe High Candela
	P4R	X	X	4-Wire Horn/Strobe
	PC4R	X	X	4-Wire Horn/Strobe
	P4RH	X	X	4-Wire Horn/Strobe High Candela
	P4W	X	X	4-Wire Horn/Strobe

Manufacturer	Model	Audio	Visual	Type
System Sensor	PC4W	X	X	4-Wire Horn/Strobe
	P4WH	X	X	4-Wire Horn/Strobe High Candela
	PC4WH	X	X	4-Wire Horn/Strobe High Candela
	P4RK	X	X	4-Wire Horn/Strobe
	PC4RK	X	X	4-Wire Horn/Strobe
	P4RHK	X	X	4-Wire Horn/Strobe High Candela
	PC4RHK	X	X	4-Wire Horn/Strobe High Candela
	PC4RH	X	X	4-Wire Horn/Strobe High Candela
	SR		X	Strobe
	SR-P		X	Strobe
	SCR		X	Strobe
	SCR-P		X	Strobe
	SRH		X	Strobe High Candela
	SRH-P		X	Strobe High Candela
	SCRH		X	Strobe High Candela
	SCRH-P		X	Strobe High Candela
	SW		X	Strobe
	SW-P		X	Strobe
	SCW		X	Strobe
	SCW-P		X	Strobe
	SWH		X	Strobe High Candela
	SWH-P		X	Strobe High Candela
	SCWH		X	Strobe High Candela
	SCWH-P		X	Strobe High Candela
	SRK		X	Strobe
	SCRK		X	Strobe
SRHK		X	Strobe High Candela	
SCRHK		X	Strobe High Candela	

Manufacturer	Model	Audio	Visual	Type
Wheelock	AH-12	X		Horn
	AH-24	X		Horn
	AH-12WP	X		Horn Weatherproof
	AH-24WP	X		Horn Weatherproof
	AMT-241575W	X	X	Multi-Tone Horn Strobe
	AMT-24MCW		X	Multi-Tone Horn Strobe
	AMT-241575W-NYC	X	X	Multi-Tone Horn Strobe
	AMT-12/24	X		Multi-tone Horn
	AMT-12/24 NYC	X		Multi-tone Horn
	AS-121575W		X	Horn/Strobe
	NH-12/24	X		Horn
	AS-241575W	X	X	Horn/Strobe
	AS-24MCC	X	X	Horn/Strobe
	AS-24MCCH	X	X	Horn/Strobe
	AS-24MCW	X	X	Horn/Strobe
	AS-24MCWH	X	X	Horn/Strobe
	ASWP-2475W	X	X	Horn/Strobe Weatherproof
	ASWP-2475C	X	X	Horn/Strobe Weatherproof
	ASWP-24MCWH	X	X	Horn/Strobe
	ASWP-24MCCH	X	X	Horn/Strobe
	CH-70	X		Chime
	CH-90	X		Chime
	CH70-241575W		X	Chime/Strobe
	CH70-24MCW		X	Chime/Strobe
	CH70-24MCWH		X	Chime/Strobe
	CH90-24MCC		X	Chime/Strobe

Manufacturer	Model	Audio	Visual	Type
Wheelock (con't)	CH90-24MCCH		X	Chime/Strobe
	HS-24	X		Horn
	HS4-241575W	X	X	Horn/Strobe
	HS4-24MCW	X	X	Horn/Strobe
	HS4-24MCWH	X	X	Horn/Strobe
	HS4-24MCC	X	X	Horn/Strobe
	MIZ-24S	X	X	Mini Horn Strobe
	MT-121575W		X	MultitoneHorn Strobe
	MT-241575W	X	X	Multitone Horn Strobe
	MT-24MCW		X	Multitone Horn Strobe
	MTWP-2475W		X	Multitone Horn Strobe
	MTWP-2475C		X	Multitone Horn Strobe
	MTG-121575W	X	X	Multitone Horn Strobe
	MTR-121575W	X	X	Multitone Horn Strobe
	MTWPA-2475W	X	X	Multitone Horn Strobe
	MTWPB-2475W	X	X	Multitone Horn Strobe
	MTWPG-2475W	X	X	Multitone Horn Strobe
	MTWPR-2475W	X	X	Multitone Horn Strobe
	MTWPA-24MCCH	X	X	Multitone Horn Strobe
	ZNH	X		Horn
	NS-121575W	X	X	Horn/Strobe
	NS-241575W	X	X	Horn/Strobe
	NS-24MCW	X	X	Horn/Strobe
	NS-24MCC	X	X	Horn/Strobe
	NS-24MCCH	X	X	Horn/Strobe
	ZNS-MCW	X	X	Horn/Strobe
	ZNS-MCWH	X	X	Horn/Strobe
	ZNS-24MCC	X	X	Horn/Strobe
	ZNS-24MCCH	X	X	Horn/Strobe
	RSS-121575W		X	Strobe
	RSS-241575W		X	Strobe
	RSS-24MCC		X	Strobe
	RSS-24MCCR		X	Strobe
	RSS-24MCCH		X	Strobe
	RSS-24MCCHR		X	Strobe
	RSS-24MCW		X	Strobe
	RSS-24MCWH		X	Strobe
	RSSP-121575W		X	Strobe
	RSSP-241575W		X	Strobe
	RSSR-2415W		X	Strobe
	RSSR-2415C		X	Strobe

Manufacturer	Model	Audio	Visual	Type	
Wheelock (con't)	RSSR-2475W		X	Strobe	
	RSSR-2475C		X	Strobe	
	RSSR-24110C		X	Strobe	
	RSSA-24110W		X	Strobe	
	RSSB-24110W		X	Strobe	
	RSSG-24110W		X	Strobe	
	RSSR-24110W		X	Strobe	
	RSSA-24MCC		X	Multi-Cd Strobe	
	RSSB-24MCC		X	Multi-Cd Strobe	
	RSSG-24MCC		X	Multi-Cd Strobe	
	RSSR-24MCC		X	Multi-Cd Strobe	
	RSSWPA-2475W		X	Strobe Weatherproof	
	RSSWPA-24MCCH		X	Strobe Weatherproof	
	RSSWPG-24MCCH		X	Strobe Weatherproof	
	RSSWPR-24MCCH		X	Strobe Weatherproof	
	RSSWP-2475W		X	Strobe Weatherproof	
	RSSWP-2475C		X	Strobe Weatherproof	
	RSSWP-24MCWH		X	Strobe Weatherproof	
	ZRS-MCWH		X	Strobe	
	ZRS-24MCC		X	Strobe	
	ZRS-24MCCH		X	Strobe	
	MB-G6-24				Motor Bell
	MB-G10-24				Motor Bell
	MB-G6-12				Motor Bell
	MB-G10-12				Motor Bell
	MIZ-24-R				Mini-Horn
	MT-12/24-R	X	X		Multitone Horn
	MT4-12/24	X	X		Multitone Horn
	ZRS-MCW			X	Strobe
	MTWPR-24MCCH	X	X		Multitone Horn Strobe
	NH-12/24R	X			Horn
	HSR			X	Horn/Strobe
	HSW			X	Horn/Strobe
	STR			X	Strobe
	STW			X	Strobe
	HNR			X	Horn
HNW			X	Horn	

A.2 Four-Wire Smoke Detectors/Devices (UL Listed)

Table A-2 Compatible Four-Wire Smoke Detectors

Smoke Detector/Base	Detector Type	Max Standby Current (mA)	Alarm Current (mA)
Fenwal CPD-7021 (w/70-201000-005 Base)	Ionization	0.10	*
Fenwal PSD-7125	Photoelectric	0.10	*
Fenwal PSD-7126 (w/70-201000-005 Base)	Photoelectric	0.10	*
Fire-Lite BLP-12-4W	Base	*	*
Gentex 824	Photoelectric	0.50	*
Gentex 824T	Photoelectric	0.50	*
Gentex 824CP	Photoelectric	0.50	*
Gentex 824CPT	Photoelectric	0.50	*
Hochiki HSC-4R	Base	*	*
Hochiki SPB-24	Projected Beam	0.25	*
System Sensor B112LP	Base	0.12	36
System Sensor B114LP	Base	*	*
System Sensor B404B	Base	*	*
System Sensor DH100ACDC	Photoelectric	0.15	0.70
System Sensor DH100ACDCLP	Photoelectric	0.15	0.70
System Sensor DH100ACDCLWP	Photoelectric	0.15	0.70
System Sensor DH400ACDCI	Ionization Duct	25	95
System Sensor DH400ACDCP	Photoelectric Duct	25	95
System Sensor 1112/24/D	Ionization	0.05	50
System Sensor 1424	Ionization	0.10	41
System Sensor 1451 (w/B402B Base)	Ionization	0.10	39
System Sensor 2112/24ATR	Photoelectric	0.50	60/70
System Sensor 2112/24AITR	Photoelectric	0.50	60/70
System Sensor 2112/24/D	Photoelectric	0.05	50
System Sensor 2112/24R	Photoelectric	0.50	60/70
System Sensor 2112/24TR	Photoelectric	0.50	60/70
System Sensor 2112/24T/D	Photoelectric w/135° Thermal	0.05	50
System Sensor 2112/24TSRB	Photoelectric w/135° Thermal Supervisory Relay	15	45
System Sensor 2312/24TB	Photoelectric	0.12	50
System Sensor 2412 (12 volt)	Photoelectric	0.12	77
System Sensor 2412AT (12 volt)	Photoelectric	0.12	58
System Sensor 2412TH (12 volt)	Photoelectric	0.12	77
System Sensor 2424	Photoelectric	0.10	41
System Sensor 2424TH	Photoelectric	0.10	41
System Sensor 2451	Photoelectric	0.10	39
System Sensor 2451TH (with/B402B Base)	Photoelectric	0.10	39
System Sensor 2W-MOD	Loop Test/Maintenance Mod.	30	50
System Sensor 4W-B (12/24 Volt)	Photoelectric I ³	.05	23

Smoke Detector/Base	Detector Type	Max Standby Current (mA)	Alarm Current (mA)
System Sensor 4WT-B (12/24 Volt)	Photoelectric I ³ w/Therm	.05	23
System Sensor 4WTA-B (12/24 Volt)	I ³ Photo w/ Therm/ Sounder	.05	35
System Sensor 4WTR-B (12/24 Volt)	I ³ Photo w/ Therm/Relay	.05	35
System Sensor 4WTAR-B (12/24 Volt)	I ³ Photo w/ Therm/ Sounder/Relay	.05	50
System Sensor 4WITAR-B (12/24 Volt)	I ³ Photo w/ Isolated Therm/Sounder/Relay	.05	50
System Sensor 2W-MOD2	I ³ Loop Test/Maintenance Mod.	.05	*
System Sensor RRS-MOD	I ³ Reversing Relay/Sync Module	.05	*
System Sensor 6424	Projected Beam	10	28.4
System Sensor Beam 1224(S)	Projected Beam	17	38.5
Notes: * Contact manufacturer for current draws			

Note: Must use model 160150 end of line supervision module.

A.3 Door Holders (UL Listed)

Table A-3 list door holders that are compatible with the fire control panel.

Table A-3 Compatible Door Holders

MANUFACTURER	MODEL	TYPE	Current (mA)
Edwards	DH150A	Floor Mount	96
Edwards	DH154A	Flush Mount	96
Edwards	DH158A	Surface Mount	96
Rixon Firemark	FM-980	Floor Mount, single	68
Rixon Firemark	FM-996	Surface Wiring	68
Rixon Firemark	FM-998	Concealed Wiring	68

A.4 Relays (UL Listed)

Table A-4 list relays compatible with the fire control panel.

Table A-4 Compatible Relays

MANUFACTURER	MODEL	Current (mA)
Air Products & Controls, LTD	MR-101/C	15
	MR-201/C	35
	PAM-1	15
	PAM-2	15
	PAM-SD	15
System Sensor	A77-716B	20
	PR-1	15
	PR-2	30
	PR-3	30
	EOLR-1	30
	R-10T	23
	R-14T	23
	R-20T	40
	R-24T	40
	R-10E	23
	R-14E	23
	R-20E	40
	R-24E	40

A.5 Accessory Modules (UL Listed)

Table A-5 lists accessory modules compatible with the fire control panel

Table A-5: Compatible Accessory Modules

Manufacturer	Model	Current (mA)
Silent Knight	5635	40

Silent Knight Fire Product Warranty and Return Policy

General Terms and Conditions

- All new fire products manufactured by Silent Knight have a limited warranty period of 36 months from the date of manufacture against defects in materials and workmanship. See limited warranty statement for details.
- This limited warranty does not apply to those products that are damaged due to misuse, abuse, negligence, exposure to adverse environmental conditions, or have been modified in any manner whatsoever.

Repair and RMA Procedure

- All products that are returned to Silent Knight for credit or repair require a RMA (Return Authorization) number. Call Silent Knight Customer Service at 800-328-0103 or 203-484-7161 between 8:00 A.M. and 5:00 P.M. EST, Monday through Friday to obtain a return authorization number.
- Silent Knight Technical Support is available at 800-446-6444 between 8:00 A.M. and 5:00 P.M. CST, Monday through Friday.
- All returns for credit are subject to inspection and testing at the factory before actual determination is made to allow credit.
- RMA number must be prominently displayed on the outside of the shipping box. See return address example under Advanced Replacement Policy.
- Included with each return should be: a packing slip that has the RMA number, a content list, and a detailed description of the problem.
- All products returned to Silent Knight must be sent freight pre-paid. After product is processed, Silent Knight will pay for shipping product back to customer via UPS ground.
- Return the Silent Knight product circuit board only. Products that are returned in cabinets will be charged an additional \$50 to cover the extra shipping and handling costs over board only returns. **Do not return batteries.** Silent Knight has the authority to determine if a product is repairable. Products that are deemed un-repairable will be returned to the customer.
- Product that is returned that has a board date code more than 36 months from date of manufacture will be repaired and the customer will be assessed the standard Silent Knight repair charge for that model.

Advanced Replacement Policy

- Silent Knight offers an option of advance replacement for fire product printed circuit boards that fail during the first 6 months of the warranty period. These items must be returned with transportation charges prepaid and must be accompanied by a return authorization.
- For advance replacement of a defective board, contact your local Silent Knight distributor or call Silent Knight at 800-328-0103 to obtain a RMA (Return Authorization) number and request advanced replacement.
- A new or refurbished board will be shipped to the customer. The customer will initially be billed for the replacement board but a credit will be issued after the repairable board is received at Silent Knight. All returned products must comply with the guidelines described under “General Terms and Conditions” and “Repair and RMA Procedure”.
- The defective board must be returned within 30 days of shipment of replacement board for customer to receive credit. No credit will be issued if the returned board was damaged due to misuse or abuse.
- Repairs and returns should be sent to:
Silent Knight / Honeywell
Attn: Repair Department
12 Clintonville Road
Northford, CT 06472
USA

RA Number:_____

Manufacturer Warranties and Limitation of Liability

Manufacturer Warranties. Subject to the limitations set forth herein, Manufacturer warrants that the Products manufactured by it in its Northford, Connecticut facility and sold by it to its authorized Distributors shall be free, under normal use and service, from defects in material and workmanship for a period of thirty six months (36) months from the date of manufacture (effective Jan. 1, 2009). The Products manufactured and sold by Manufacturer are date stamped at the time of production. Manufacturer does not warrant Products that are not manufactured by it in its Northford, Connecticut facility but assigns to its Distributor, to extent possible, any warranty offered by the manufacturer of such product. This warranty shall be void if a Product is altered, service repaired by anyone other than Manufacturer or its authorized Distributors. This warranty shall also be void if there is a failure to maintain the Products and the systems in which they operate in proper working conditions.

MANUFACTURER MAKES NO FURTHER WARRANTIES, AND DISCLAIMS ANY AND ALL OTHER WARRANTIES, EITHER EXPRESSED OR IMPLIED, WITH RESPECT TO THE PRODUCTS, TRADEMARKS, PROGRAMS AND SERVICES RENDERED BY MANUFACTURER INCLUDING WITHOUT LIMITATION, INFRINGEMENT, TITLE, MERCHANTABILITY, OR FITNESS FOR ANY PARTICULAR PURPOSE. MANUFACTURER SHALL NOT BE LIABLE FOR ANY PERSONAL INJURY OR DEATH WHICH MAY ARISE IN THE COURSE OF, OR AS A RESULT OF, PERSONAL, COMMERCIAL OR INDUSTRIAL USES OF ITS PRODUCTS.

This document constitutes the only warranty made by Manufacturer with respect to its products and replaces all previous warranties and is the only warranty made by Manufacturer. No increase or alteration, written or verbal, of the obligation of this warranty is authorized. Manufacturer does not represent that its products will prevent any loss by fire or otherwise.

Warranty Claims. Manufacturer shall replace or repair, at Manufacturer's discretion, each part returned by its authorized Distributor and acknowledged by Manufacturer to be defective, provided that such part shall have been returned to Manufacturer with all charges prepaid and the authorized Distributor has completed Manufacturer's Return Material Authorization form. The replacement part shall come from Manufacturer's stock and may be new or refurbished. THE FOREGOING IS DISTRIBUTOR'S SOLE AND EXCLUSIVE REMEDY IN THE EVENT OF A WARRANTY CLAIM.



















**SILENT
KNIGHT**

by Honeywell

Model 5600/5600C/5600HV Basic Operating Instructions

These Instructions must be framed and displayed next to the 5600 panel in accordance with NFPA 72 fire code for Local Protected Fire Alarm Systems. Test the system in accordance to NFPA 72. Refer to Installation Manual P/N 151450 for more information regarding this control panel.

Operation	Task to Perform
Silence Alarms and Troubles	Press  . Silence LED will light.
Reset Alarms	Press  .
Acknowledge Alarms and Troubles	Press  .
View Alarms	Zones that are in alarm will have their alarm LED on. To view all points in alarm press Alarm ID followed by  or  button to view the SLC ID for each point.
View Supervisories	Zones that are in supervisory will have their supervisory LED on. To view all points in supervisory press Supervs ID followed by  or  button to view the SLC ID for each point.
View Troubles	Zones that are in trouble will have their trouble LED on. To view all points in trouble press Trouble ID followed by  or  button to view the SLC ID for each point.
Conduct a Fire Drill	1. Press  to start Fire Drill. 2. Press  to end Fire Drill.
Dialer Test	Press  and  key at same time.
Lamp Test	Press  and  key at same time.
Enable / Disable a Zone or Circuit	Press the corresponding disable key. Press it again to enable the zone or circuit. For ULC, you must enter the Installation code after pressing Zone Enable/Disable.
Remote Connection Feature (ULC Installations Only)	Press the  and  at the same time to disconnect the communication paths to the Central Station and/or remote station. The PZT on the panel will sound and the General Trouble LED will be flashing. This will remain active until you press the Walk test and Acknowledge buttons again.
For Service call:	

P/N 53610 Rev. A

ECN 10-157

Cut Along the Dotted Line



**SILENT
KNIGHT**

by Honeywell

Silent Knight
12 Clintonville Road
Northford, CT 06472-1610
203-484-7161
Fax: 203-484-7118

www.silentknight.com