

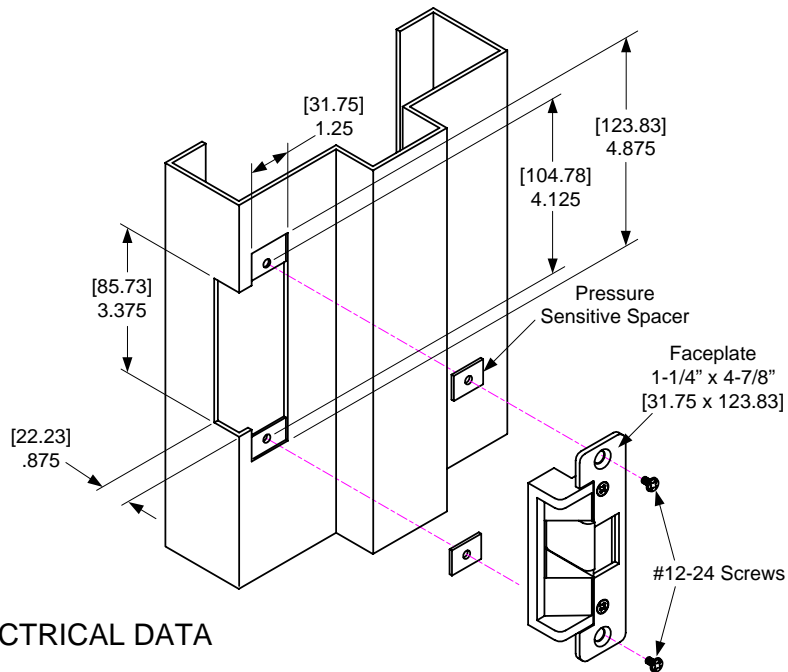

15 SERIES ELECTRIC STRIKE INSTALLATION INSTRUCTIONS



ELECTRICAL DATA

FAIL SAFE = 200mA @ 12VDC

50mA @ 24VDC

FAIL SECURE = 200mA @ 12VDC

50mA @ 24VDC

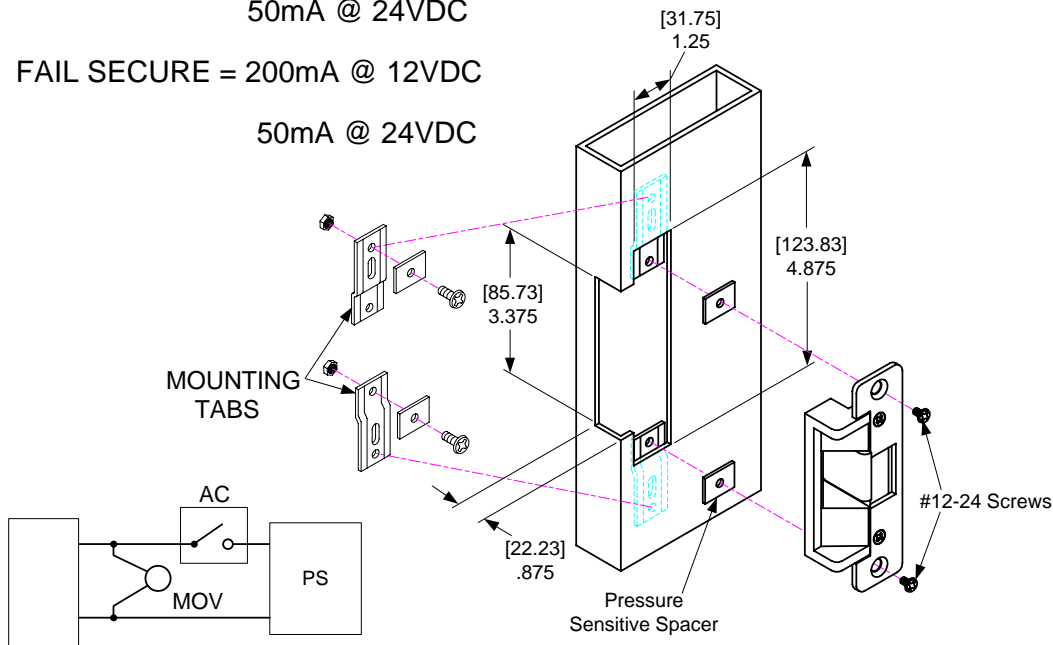

Any suggestions or comments to this instruction or product are welcome. Please contact us through our website or email engineer@sdsecurity.com